

elco

HEATING

CATALOGUE



elco

HEATING

CATALOGUE

| | |
|-------------------|--------|
| THE COMPANY | p. 4 |
| RANGE OVERVIEW | p. 16 |
| GAS BURNERS | p. 26 |
| DUAL FUEL BURNERS | p. 136 |
| LIGHT OIL BURNERS | p. 162 |
| KIT & OPTIONS | p. 198 |



CUTTING-EDGE BURNERS FOR HEATING AND INDUSTRIAL APPLICATIONS

OUR COMPANY

Since its foundation in 1928, ELCO has always been a specialist in burners conception and manufacturing. By linking a strong innovative ability to a continued developing drive, ELCO has designed high performing and reliable burners as well as corresponding services throughout the years, and is today one of the leaders in the field of combustion technology.

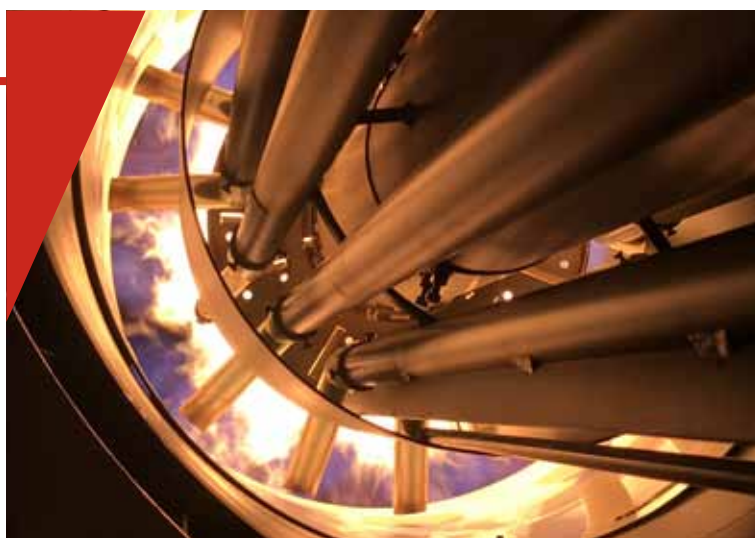

OUR MISSION

ELCO always looks for the best technologies and continues to develop new ones to improve the efficiency of its solutions.

Our R&D Laboratories are committed to develop innovative technological solutions allowing to:

- optimise the running of the installations lowering costs;
- offer service friendly products easy to maintain;
- preserve the environment lowering acoustic and pollutant emissions.



OUR KNOWLEDGE

Your contacts at ELCO and its partners are recognised experts with years of experience. Our worldwide support starts from concept creation to planning, design and project management up to commissioning and on-going operation of the plant throughout its life cycle.

As an ELCO customer, you can count on us for products that guarantee reliability, quality and high performance in any application and working condition.



OUR SERVICE NETWORK

Taking advantage of a staff composed of technicians and engineers with a long experience, ELCO is able to provide professional support to the customer in order to define together the best solution and to develop and manage the project through its entire life-cycle.

ELCO Service activities define the standards in the market and each customer can rely on high performance and reliable products.



OUR INNOVATIVE SOUL

A right mix of experience and spirit of innovation gives ELCO the push to constantly refine its products and develop new ones to respond to market demands, in particular those related to the reduction of polluting emissions.

The growing attention to issues related to the environment has led to the development of advanced combustion technologies that use alternative fuels, as happens for example with hydrogen burners, a product of the future that ELCO is already able to offer today.



TECHNICAL ASSISTANCE

For safe and efficient operation of your burner system it is very important that the burner is commissioned by a competent person. The combustion will be optimally adjusted over the whole power range of the burner, and all the safety devices will be tested. To keep your installation in good conditions, it is important to maintain the burner periodically. It is also very important to inspect all the safety devices to ensure that your system operates safely. Fortunately, you can rely on the professional services of ELCO which can perform this service for you.



BURNER ACADEMY

In order to respond to the needs of our customers we created a Burner Academy, a real training school where the knowledge of our technicians is passed on to our trainees. We provide the opportunity for boiler room personnel, operators and engineers to attend a series of training sessions carried out on our test bench by highly qualified instructors, who hold the courses in English, German, French, Italian and Dutch language.

The Burner Academy uses various training locations where boilers are installed and where people can be trained in theory and in practice. We offer courses at different levels and also the possibility to handle all your needs in a customer-specific training.



RELIABLE SUPPLY OF SPARE PARTS

Spare parts have always had a great importance inside the ELCO world. Considering the high amount of parts involved in every single product, some of these parts might naturally need to be replaced. ELCO can count on an International network offering original spare parts in order to guarantee the highest quality, reliability and safe continued operation of the appliance.

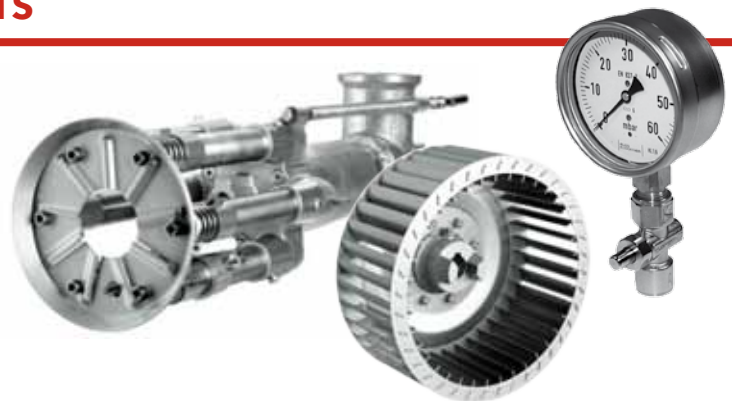

WORLDWIDE NETWORK

Capitalising on more than 90 years of work experience, ELCO has been capable to build up loyal partnerships and today can count on reliable Partners all over the World.

Combining an instinctively global perspective with a genuinely multicultural approach ELCO today offers you skilled and experienced experts available in more than 70 Countries.

In Europe

3 production plants
6 commercial branches
Strong commercial presence through a network of reliable dealers and partners

Worldwide

2 Sales Offices in Russia and China
Distribution in over 70 Countries

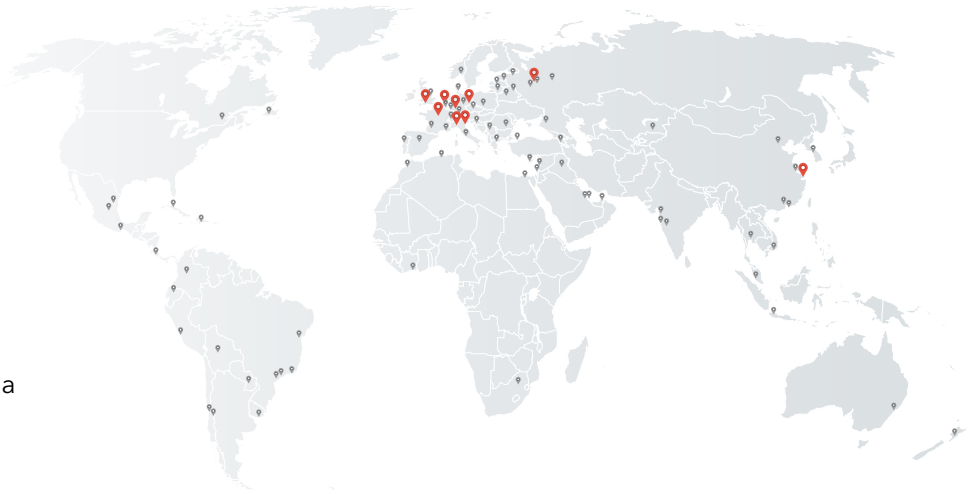

Service Network

In Western Europe, ELCO has a well organised service network. Outside Western Europe ELCO uses a network of partners, consisting of well-trained local engineers, to carry out its service operations. These technicians are able to perform both commissioning and local service and they do it in a very professional and efficient way.

ELCO ON THE WEB

We are constantly looking forward to provide to our customers new technologies, products and services. Stay always up to date on the latest news from the ELCO World visiting our website:

www.elco-burners.com

Navigate to explore the ELCO proposal and choose the perfect product to fit your needs, and follow us to know more about our new activities and projects.

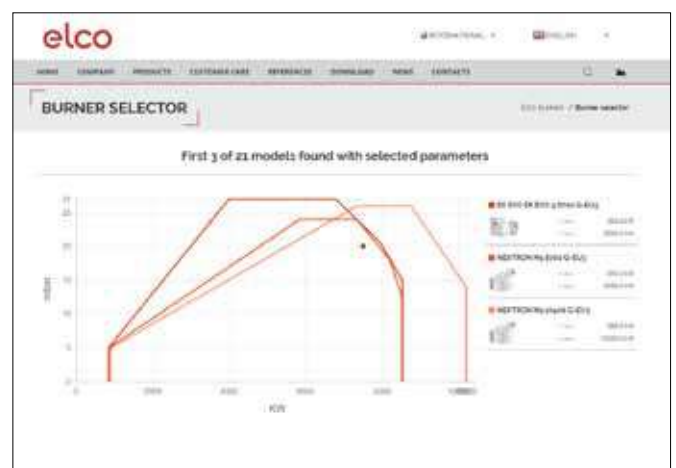
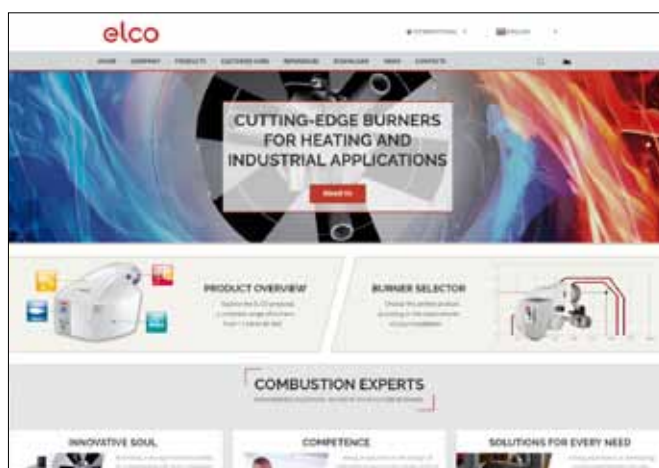

OUR PRODUCT RANGE

Our experience at combustion technology available in a complete range of burners from 11 kW to 80 MW:

Monoblock range:



VECTRON
11 - 2300 kW
 Gas
 Light oil
 Dual fuel



PROTRON
15 - 550 kW
 Gas
 Light oil



NEXTRON
250 - 11200 kW
 Gas
 Light oil
 Dual fuel



EK EVO
250 - 13500 kW
 Gas
 Light oil
 Dual fuel



N
1300 - 22000 kW
 Gas
 Light oil
 Dual fuel



HO-TRON
68 - 17000 kW
 Heavy oil



GHO-TRON
414 - 17000 kW
 Heavy oil
 Dual fuel

Duoblock range:



D-TRON
230 - 34000 kW
 Gas
 Light oil
 Gas / light oil
 Heavy oil
 Gas / heavy oil



EK-DUO
600 - 16000 kW
 Gas
 Light oil
 Dual fuel



RPD
500 - 80000 kW
 Gas
 Light oil
 Gas / light oil
 Heavy oil
 Gas / heavy oil

ELCO SYSTEMS AND TECHNOLOGIES

To constantly improve its products, ELCO is committed to develop innovative technological solutions allowing to optimise the running of the installations, to ease technicians work, and naturally to preserve the environment. In order to provide quick responses to its market's demands, the range of ELCO burners is entirely conceived around a consistent combination of Systems.

MDE2 SYSTEM

Permanent communication of information easy to use



Equipped with the MDE2 System, the universal language Elcogram and the 5-button keyboard, ELCO burners adjust themselves and constantly communicate to the technicians and operators:

- real time information about each ignition and during the running;
- statistical information about the burner operations recorded during the whole year before the maintenance operations.

"ELCOGRAM":
universal language
based on symbols
and numerical data

Display shows
all information for
daily operation

Menu-driven burner
setup and operation
via keypad

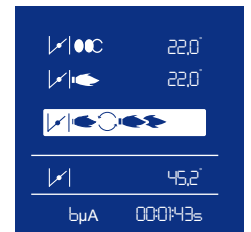
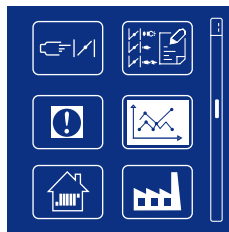

Elcogram, a universal language

As ELCO products are distributed worldwide, the company has developed a universal language composed of pictograms and numerical data. The pictograms use the majority of the symbols used on the wiring diagrams which are recognised and understood by all Nations. This ensures that information is easier to read than ever before.

GEM SYSTEM

Electronic burner control: high safety and low costs



The use of electronic technologies in burner control systems helps to reduce running costs, improve reliability of operation and lower pollutant emissions. The electronic combustion manager used on ELCO burners are responsible not only for the burner control (formerly the task of the traditional automatic combustion control unit) but also for fuel/air regulation. Data stored electronically has replaced the mechanical characteristic curve and help to achieve an unprecedented level of precision in air/fuel ratio regulation across the burner's entire control range, a prerequisite for efficient, energy- and cost-saving operation.

The GEM System controls the position of one or more activators simultaneously.

The servomotors of the air flow and oil components are controlled by a microprocessor which contains set points defined for each load curve. An additional advantage of the GEM is that it provides specific information on all the commands and current situation of the overall system: these can be accessed directly or by remote control.

The digital programming is user-friendly, it is carried out through the display of the MDE2 System or through a PC by using a simple procedure facilitated by easy instructions in a clear language.

ELCO SYSTEMS AND TECHNOLOGIES

AGP SYSTEM

An outstanding technology for gas burners



Developed and produced by ELCO, the AGP System (proportional air-gas) provides:

- perfect stability of the air-gas mixture;
- a constantly high CO₂ content over the whole burner power range;
- precise control of air excess, which is important for high-efficiency operation, in particular for condensing generators.

The AGP measures: the gas pressure downstream of the gas train, the air pressure behind the flame holder and the furnace backpressure.

Any variations in the three pressures are immediately and simultaneously recorded by the system which automatically restores the correct gas/combustion air ratio.

AGP maintains a constant gas/combustion air ratio even in the presence of:

- positive or negative variations in the gas pressure;
- variations in air flow due to changes in the electrical supply voltage or fouling of the ventilation system;
- variations in the furnace and flue draft pressure on start-up and during load changes.

VARIATRON

Speed regulation: noise reduction and energy saving



To improve the performance of heating or industrial systems, ELCO applies Variatron (fan speed control).

Conventionally, the air in modulating burners is regulated by an air flap. In the partial load range, a large amount of the air pressure generated by the ventilator goes to waste.

With speed regulation, the speed of the combustion-air fan is varied continuously depending on the burner output required. Full speed is reached only at maximum burner output. In the predominant partial load range, lower speed translates into significant reductions in power consumption and noise emissions.

The Variatron operates in step with the air damper both with the GEM System and with the AGP System, which guarantees a combustion with minimum air excess by continuously monitoring all operating conditions.

Application of the Variatron to ELCO burners results in:

- electrical consumption savings in the order of 50%;
- turndown ratio of up to 1:10, resulting in perfect adaptation to system requirements and improvement in average seasonal efficiency, in particular with condensing or low-temperature boilers or specific processes;
- silent start-up and average overall noise reduction between 2 dB(A) (at maximum power) and 12 dB(A) (at minimum power).

LOW NOISE SYSTEM

Increase the comfort in-use and protect the environment



Among all the harmful things that people have to bear with every day life, the most annoying is noise, which is difficult to reduce and expensive to reduce.

This is the reason why ELCO has developed quiet burners both by selecting sound absorbent materials, and by treating each noise sources internally. The main noise comes from the air intake and the air mixing in the fan wheel: all the ELCO burners are equipped with a sound trap on the air intake channel leading to the fan.

This brings the acoustic level to an acceptable value in respect of the environment.

COMBUSTION TECHNOLOGIES

DIAMOND HEAD

Low emissions and reliable operation



The principle of Diamond Head combustion technology is based on the internal recirculation of the combustion flue gases. The gases are partially drawn into the base of the flame via triangular openings placed at the end of the combustion head. The position and geometry of the gas injectors are such that a significant quantity of combustion flue gas is drawn in and rapidly mixed with air and gas at the root of the flame. This mixture crosses the main reaction area, slowing the combustion, which resulted in lowering the main flame temperature. The result of this staging combustion is a significant reduction in the formation of thermal nitrogen oxides. The advantage of this internal recirculation technique is an automatic adjustment to the quantity of recycled combustion flue gases: the volume of the flame is always as low as possible, which has a very minor effect on the nominal power of the generator, unlike external recirculation systems.



FREE FLAME

The pinnacle of low-polluting burner engineering



The Free Flame combustion technology is based on the internal recirculation of the flue gas, combined with high speed flow of the fuel air mixture. The flame stabilizes at a certain distance from the combustion head, thus leaving space for the mixture of reagents and flue gas. This phenomenon greatly reduces NOx emissions. The flame seems to float in the furnace, thus giving the system its name: «Free Flame».

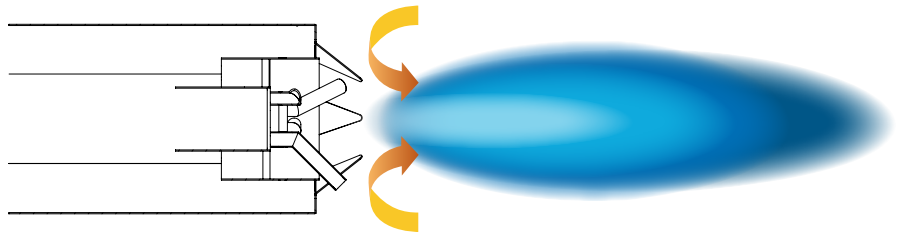

FGR SYSTEM

Ultra low NOx solutions to reach emissions of less than 30 mg/kWh



Thanks to its experience and the technologies it has developed over the years, ELCO offers a wide range of products which use the external FGR technology to reduce NOx emissions and satisfy even the most stringent regulations. The principle of external flue gas recirculation consists in sending a mixture of comburent air and flue gas to the combustion head, thus reducing the NOx emissions. The gases are mixed upline of the combustion process by the burner fan (for monoblock units) or by the external fan (in case of duoblock burners). This technology enables ELCO to guarantee emissions of less than 30 mg/kWh, a value which is hard to obtain with conventional combustion systems, and offer cutting-edge products which satisfy the requirements of any current regulations.

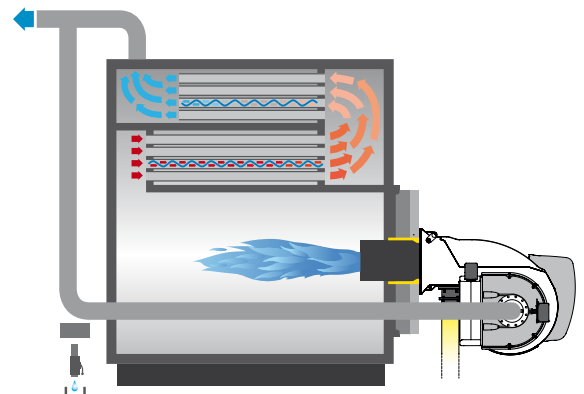

WORLDWIDE REFERENCES

Musselkanaal, The Netherlands

Fuel:
Natural gas

Total nominal output:
1600 kW

Burners:
2x VG4.610 M



Altchemnitz, Germany

Fuel:
Natural gas

Total nominal output:
132 MW

Burners:
6x N11.22000 G-EU1



Velikiye Luki, Russia

Fuel:
Natural gas and dual fuel (gas/light oil)

Total nominal output:
13 MW

Burners:
2x EK EVO 7.3600 G-E
1x EK EVO 7.4500 GL-EZ3



WORLDWIDE REFERENCES

Vries, The Netherlands

Fuel:
Natural gas

Total nominal output:
350 kW

Burners:
1x VG3.350 D E



Beijing, China

Fuel:
Natural gas

Total nominal output:
180 MW

Burners:
4x RPD 100 G-EU



Seoul, South Korea

Fuel:
Natural gas

Total nominal output:
50 MW

Burners:
7x N8.7100 G-EU3



WORLDWIDE REFERENCES

Beijing, China

Fuel:

Natural gas

NOx emissions:

Installation with FGR system to reach
NOx levels below 30 mg/kWh

Burners:

1x EK EVO 8.5800 G-EU3 FGR
2x EK EVO 8.7100 G-EU3 FGR



Bialystok, Poland

Fuel:

Natural gas

Total nominal output:

41 MW

Burners:

2x RPD 70 G-EU2



Seoul, South Korea

Fuel:

Natural gas and dual fuel

Total nominal output:

80 MW

Burners:

3x N10.16000.45 G-EU2 FGR
1x N10.12000.37 GL-EUF



WORLDWIDE REFERENCES

Monza, Italy

Fuel:

Natural gas

NOx emissions:

Installation with FGR system to reach
Ultra NOx emission levels

Burners:

1x N11.19000 G-EU2



Stavanger, Norway

Location:

District heating plant

Fuel:

Natural gas

Burners:

2x EK-DUO 4.1600 G-E



Beijing, China

Fuel:

Natural gas

NOx emissions:

Installation with FGR system to reach
NOx levels below 30 mg/kWh

Burners:

2x N10.16000 G-EU2 FGR



VECTRON



MAIN FEATURES

- Fuels: natural gas (G20/G25, $H_u = 8,83...10,35 \text{ kWh/m}^3$) and LPG (G31, $H_u = 25,89 \text{ kWh/m}^3$).
light oil (viscosity $6 \text{ mm}^2/\text{s}$ at 20°C , $H_u = 11,86 \text{ kWh/kg}$).
- Cubic type architecture allowing optimal accessibility, maximum compactness, minimum weight.
- Complete electrical equipment in the body of the burner with MDE2 System and display: this ensures that information is easier to read than ever before, constantly giving real-time information to professional operators, during the commissioning, the operation and at each operation cycle.
- Quiet ventilation and reduced electrical consumption.
- Closing of the air flap at burner shut-down.
- Maintenance operation are simplified: the combustion parts can be quickly removed, easily cleaned and, even when they are disassembled, they easily get back to their position after all the servicing work.
- Gas train factory assembled and tested for tightness and electrical security.
- All products are in compliance with EN676 and EN267 European standards and with the following directives:
 - 2014/35/EU Low Voltage Directive
 - 2014/30/EU EMC Directive
 - 2016/426/EU Gas Appliance Regulation
 - 2006/42/EC Machine Directive
- All products up to VG4.440 and VL4.440 D are in compliance with ErP Directive

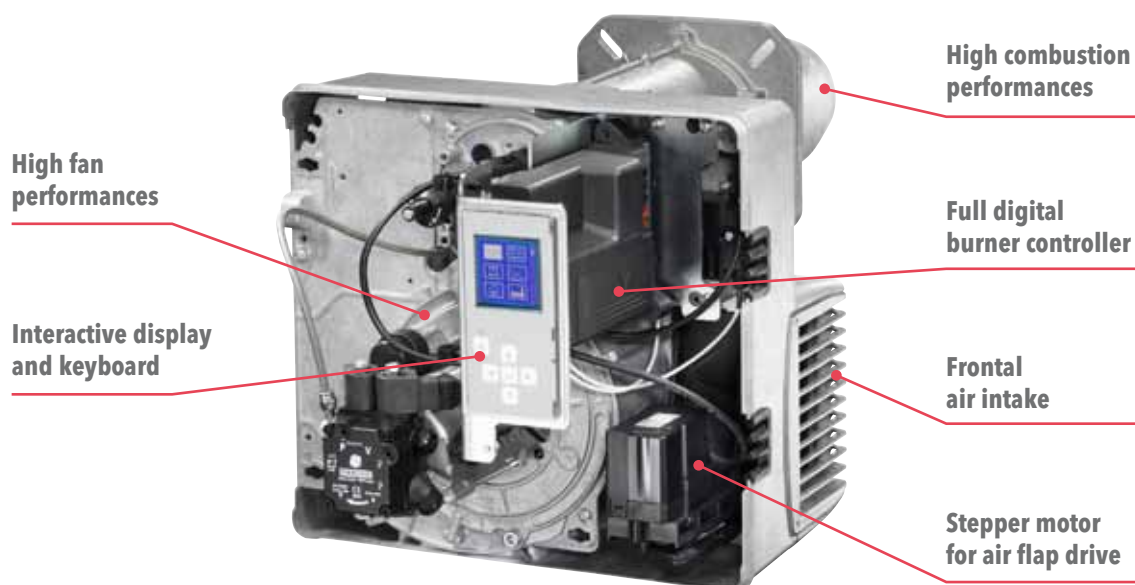

EK EVO**MAIN FEATURES**

EK EVO 4 and 5 are two stage progressive/modulating forced draught burners, working with light oil and equipped with low emission combustion technology, that makes these burner series able to outperform the most rigid regulation in terms of pollutant emissions.

- Fuel: light oil (viscosity 6 mm²/s at 20°C, Hu = 11,86 kWh/kg)
- Fully electronic modulation system for a smooth and efficient operation of the burner (GEM System)
- Low NO_x class 3 combustion head providing NO_x values well below the limit of 120 mg/kWh imposed by the EN267/2020 Directive
- Simple and intuitive switch cabinet to meet the majority of the application requirements
- Backlit display with a 5-buttons keyboard on the switch cabinet providing real-time information on the operation of the burner through ELCOGRAM, the ELCO universal language based on symbols and numerical data
- Burner control, power regulator and all other options can be installed on the switch cabinet thanks to a modular concept design
- Easily adjustable sliding combustion head with dedicated servomotor assuring high adaptability to varying boiler situations and required emission level
- Secured burner head adjustments for easy and fast maintenance operations (RTC System)
- Closing of the air damper on burner shut-down
- Versions for continuous operation available (PED configuration)
- All products are in compliance with EN267 European standards and with the following directives:
 - 2014/35/EU Low Voltage Directive
 - 2014/30/EU EMC Directive
 - 2006/42/EC Machine Directive

NO_x EMISSION VALUES

The EK EVO 4 and 5 are equipped with Low NO_x combustion head that makes these burners able to work below 80 mg/kWh, well below the limit of 120 mg/kWh imposed by the EN267/2020 Directive.

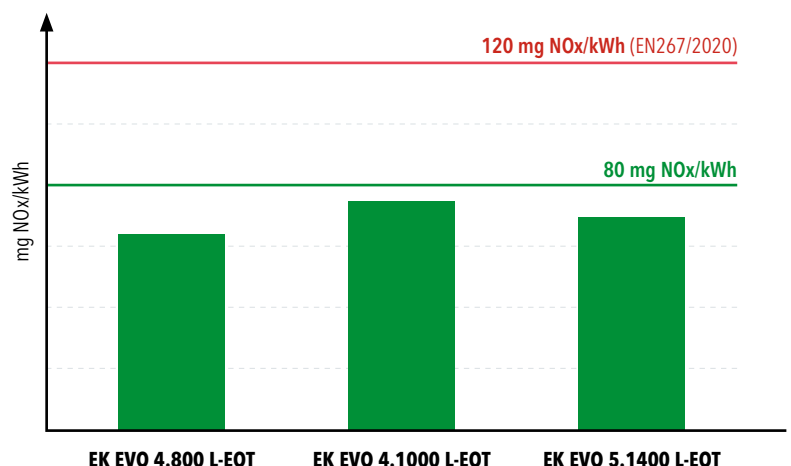

BURNERS

FUEL AND COMBUSTION TYPE

- G** = Natural gas
- GL** = Dual fuel (natural gas/light oil)
- L** = Light oil standard
- B** = Light oil Low NOx Blue flame
- E** = Light oil Low NOx Yellow flame

ERP COMPLIANCE

- = not compliant
- E** = compliant (for gas only)

ADDITIONAL EQUIPMENT

- /TC** = Tightness control
- /PED** = PED equipped
- /FGR** = FGR equipped

HEAD LENGTH

- KN** = short
- KM** = medium
- KL** = long

ELECTRICAL SUPPLY

- = 230V / 50Hz
- 6H** = 230V / 60Hz
- 110** = 110-120 V/50-60 Hz

VG3.290 M E /TC KN 6H

PLATFORM

From 1 to 6

SIZE

Max power (kW)

OPERATION TYPE

- = 1 stage
- P** = 1 stage standard with pre-heater (light oil)
- D** = 2 stages
- DP** = 2 stage progressive/modulating pneumatic Low NOx (gas) / 3 stages (light oil)
- DP R** = 2 stage progressive/modulating pneumatic
- V** = 2 stage progressive/modulating pneumatic + fan speed control
- VD** = 2 stages PWM Low NOx (light oil)
- M** = 2 stage progressive/modulating electronic Low NOx
- M R** = 2 stage progressive/modulating electronic
- M V** = 2 stage progressive/modulating electronic Low NOx + fan speed control
- M V R** = 2 stage progressive/modulating electronic + fan speed control

RANGE

EK EVO
Platform 4 and 5

OPERATION TYPE

E = 2 stage progressive/
modulating electronic

COMBUSTION TYPE

OT = Low NOx class 3 (according to EN267)
with optimisation of air flow rate

EK EVO 4.1000 L-EOT /BT3 /PED

SIZE

Approximate
power (kW)

FUEL

L = Light oil

ELECTRICAL
EQUIPMENT

/BT3 = BT300

OPTIONAL CONFIGURATIONS

/PED = continuous operation

GAS TRAINS

VALVE MANUFACTURER

d = Dungs
s = Siemens
k = Kromschröder
h = Honeywell

VALVE NOMINAL DIAMETER

1/2" ... 2" or 50 ... 100 mm

GAS TRAIN CONNECTION DIAMETER

Rp1/2" ... Rp2" (when threaded) or DN50 ... 100 (when flanged)

d335 - 1"1/2 - Rp2" /TC 110

OPERATION TYPE

1 = 1 stage
2 = 2 stages
3 = Pneumatic
4 = Electronic

SERIES

Progressive number

ADDITIONAL EQUIPMENT

/TC = Tightness control

ELECTRICAL SUPPLY

- = 230V / 50Hz
110 = 110-120 V/50-60 Hz

OTHER BURNER VERSIONS

- 60 60 Hz version
- TC Version with tightness control
- Ver Versions for continuous ventilation and post-ventilation
- PED PED version for continuous operation
- ErP ErP compliant

ONE STAGE / Low NOx

| | | | | | | |
|---------------|----|------|-----|----------------|--|-------|
| VG1.40 E /TC | 60 | VENT | ErP | 15 ... 41 kW | | p. 26 |
| VG1.55 E /TC | 60 | VENT | ErP | 35 ... 55 kW | | p. 26 |
| VG1.105 E /TC | 60 | VENT | ErP | 50 ... 105 kW | | p. 26 |
| VG2.140 E | 60 | VENT | ErP | 80 ... 140 kW | | p. 28 |
| VG2.205 E | 60 | VENT | ErP | 130 ... 205 kW | | p. 28 |

TWO STAGES / Low NOx

| | | | | | | | |
|-------------|----|------|------|----------------|----------------|-------|-------|
| VG1.105 D E | 60 | VENT | ErP | 37 ... 105 kW | | p. 30 | |
| VG2.120 D E | 60 | VENT | ErP | 40 ... 120 kW | | p. 32 | |
| VG2.160 D E | 60 | VENT | ErP | 50 ... 160 kW | | p. 32 | |
| VG2.205 D E | 60 | VENT | ErP | 65 ... 205 kW | | p. 32 | |
| VG3.290 D E | 60 | TC | VENT | ErP | 95 ... 290 kW | | p. 34 |
| VG3.350 D E | 60 | TC | VENT | ErP | 105 ... 350 kW | | p. 34 |
| VG4.440 D E | 60 | TC | VENT | ErP | 110 ... 440 kW | | p. 38 |
| VG4.460 D | 60 | TC | VENT | 150 ... 460 kW | | p. 42 | |



































TWO STAGE PROGRESSIVE/MODULATING PNEUMATIC / Low NOx

| | | | | | | | |
|-----------------|----|------|------|-----------------|----------------|-------|-------|
| VG2.120 DP E | 60 | VENT | ErP | 40 ... 120 kW | | p. 46 | |
| VG2.160 DP E | 60 | VENT | ErP | 50 ... 160 kW | | p. 46 | |
| VG2.205 DP E | 60 | VENT | ErP | 65 ... 205 kW | | p. 46 | |
| VG3.290 DP E | 60 | TC | VENT | ErP | 95 ... 290 kW | | p. 48 |
| VG3.350 DP E | 60 | TC | VENT | ErP | 105 ... 350 kW | | p. 48 |
| VG4.440 DP E | 60 | TC | VENT | ErP | 110 ... 440 kW | | p. 52 |
| VG4.460 DP | 60 | TC | VENT | 100 ... 460 kW | | p. 56 | |
| VG4.610 DP | 60 | TC | VENT | 130 ... 610 kW | | p. 56 | |
| VG5.950 DP | 60 | TC | VENT | 170 ... 950 kW | | p. 60 | |
| VG5.1200 DP | 60 | TC | VENT | 250 ... 1160 kW | | p. 60 | |
| VG6.1600 DP /TC | 60 | VENT | | 300 ... 1600 kW | | p. 64 | |
| VG6.2100 DP /TC | 60 | VENT | | 400 ... 1900 kW | | p. 64 | |













TWO STAGE PROGRESSIVE/MODULATING PNEUMATIC + fan speed control / Low NOx

| | | | | | | |
|-------------|----|------|-----|----------------|--|-------|
| VG2.205 V E | | VENT | ErP | 65 ... 205 kW | | p. 68 |
| VG3.290 V E | TC | VENT | ErP | 95 ... 290 kW | | p. 70 |
| VG3.350 V E | TC | VENT | ErP | 105 ... 350 kW | | p. 70 |
| VG4.440 V E | TC | VENT | ErP | 110 ... 440 kW | | p. 82 |
| VG4.460 V | TC | VENT | | 100 ... 460 kW | | p. 78 |
| VG4.610 V | TC | VENT | | 130 ... 610 kW | | p. 78 |















TWO STAGE PROGRESSIVE/MODULATING ELECTRONIC / Low NOx

| | | | | | | | | | |
|-----------------|---|-----------------|--|--|--|--|--|--|--------|
| VG2.120 M E /TC |   | 40 ... 120 kW |  | | | | | | p. 82 |
| VG2.160 M E /TC |   | 50 ... 160 kW |  | | | | | | p. 82 |
| VG2.205 M E /TC |   | 65 ... 205 kW |  | | | | | | p. 82 |
| VG3.290 M E /TC |   | 95 ... 290 kW |  | | | | | | p. 84 |
| VG3.350 M E /TC |   | 105 ... 350 kW |  | | | | | | p. 84 |
| VG4.440 M E /TC |   | 110 ... 440 kW |  | | | | | | p. 88 |
| VG4.460 M /TC |  | 86 ... 460 kW |  | | | | | | p. 92 |
| VG4.610 M /TC |  | 90 ... 610 kW |  | | | | | | p. 92 |
| VG5.950 M /TC |   | 160 ... 900 kW |  | | | | | | p. 96 |
| VG5.1200 M /TC |   | 160 ... 1160 kW |  | | | | | | p. 96 |
| VG6.1600 M /TC |   | 240 ... 1600 kW |  | | | | | | p. 100 |
| VG6.2100 M /TC |   | 260 ... 1900 kW |  | | | | | | p. 100 |













TWO STAGE PROGRESSIVE/MODULATING ELECTRONIC + fan speed control / Low NOx

| | | | | | | | | | |
|------------------|---|-----------------|--|--|--|--|--|--|--------|
| VG5.950 M V /TC |   | 160 ... 900 kW |  | | | | | | p. 104 |
| VG5.1200 M V /TC |   | 160 ... 1160 kW |  | | | | | | p. 104 |
| VG6.1600 M V /TC |   | 240 ... 1600 kW |  | | | | | | p. 108 |
| VG6.2100 M V /TC |   | 260 ... 1900 kW |  | | | | | | p. 108 |













TWO STAGE PROGRESSIVE/MODULATING PNEUMATIC

| | | | | | | | | | |
|-------------------|---|-----------------|--|--|--|--|--|--|--------|
| VG5.950 DP R |    | 150 ... 1000 kW |  | | | | | | p. 112 |
| VG5.1200 DP R |    | 200 ... 1200 kW |  | | | | | | p. 112 |
| VG6.1600 DP R /TC |   | 200 ... 1700 kW |  | | | | | | p. 116 |
| VG6.2100 DP R /TC |   | 300 ... 2300 kW |  | | | | | | p. 116 |





TWO STAGE PROGRESSIVE/MODULATING ELECTRONIC

| | | | | | | | | | |
|------------------|---|-----------------|--|--|--|--|--|--|--------|
| VG5.950 M R /TC |   | 150 ... 1000 kW |  | | | | | | p. 120 |
| VG5.1200 M R /TC |   | 200 ... 1200 kW |  | | | | | | p. 120 |
| VG6.1600 M R /TC |   | 200 ... 1700 kW |  | | | | | | p. 124 |
| VG6.2100 M R /TC |   | 300 ... 2300 kW |  | | | | | | p. 124 |





TWO STAGE PROGRESSIVE/MODULATING ELECTRONIC + fan speed control

| | | | | | | | | | |
|--------------------|---|-----------------|--|--|--|--|--|--|--------|
| VG5.950 M V R /TC |   | 150 ... 1000 kW |  | | | | | | p. 128 |
| VG5.1200 M V R /TC |   | 200 ... 1200 kW |  | | | | | | p. 128 |
| VG6.1600 M V R /TC |   | 200 ... 1700 kW |  | | | | | | p. 132 |
| VG6.2100 M V R /TC |   | 300 ... 2300 kW |  | | | | | | p. 132 |





ONE STAGE in gas and in oil

| | | | | |
|----------|---|----------------|---|--------|
| VGL2.120 |  | 35 ... 120 kW |  | p. 136 |
| VGL2.210 |  | 100 ... 190 kW |  | p. 136 |









TWO STAGES in gas and in oil / Low NOx

| | | | | |
|------------|---|----------------|---|--------|
| VGL3.290 D |  | 95 ... 290 kW |  | p. 138 |
| VGL3.360 D |  | 120 ... 360 kW |  | p. 138 |









TWO STAGE PROGRESSIVE/MODULATING PNEUMATIC / Low NOx in gas / TWO STAGES in oil

| | | | | |
|-------------|---|----------------|---|--------|
| VGL4.460 DP |  | 168 ... 460 kW |  | p. 142 |
| VGL4.610 DP |  | 190 ... 610 kW |  | p. 142 |









TWO STAGE PROGRESSIVE/MODULATING ELECTRONIC / Low NOx in gas / THREE STAGES in oil

| | | | | |
|-----------------|---|-----------------|---|--------|
| VGL5.700 M /TC |  | 200 ... 700 kW |  | p. 146 |
| VGL5.1000 M /TC |  | 240 ... 1000 kW |  | p. 146 |
| VGL6.1600 M /TC |  | 300 ... 1600 kW |  | p. 150 |
| VGL6.2100 M /TC |  | 480 ... 2050 kW |  | p. 150 |







TWO STAGE PROGRESSIVE/MODULATING ELECTRONIC + fan speed control / Low NOx in gas / THREE STAGES in oil

| | | | | |
|-------------------|---|-----------------|---|--------|
| VGL5.700 M V /TC |  | 200 ... 700 kW |  | p. 154 |
| VGL5.1000 M V /TC |  | 240 ... 1000 kW |  | p. 154 |
| VGL6.1600 M V /TC |  | 300 ... 1600 kW |  | p. 158 |
| VGL6.2100 M V /TC |  | 480 ... 2050 kW |  | p. 158 |















ONE STAGE / Low NO_x, Yellow Flame

| | | | | |
|--------|---|--------------|--|--------|
| VE1.34 |   | 16 ... 34 kW |  | p. 162 |
| VE1.50 |   | 28 ... 50 kW |  | p. 162 |
| VE1.75 |   | 44 ... 75 kW |  | p. 162 |





















TWO STAGES / Low NO_x, Yellow Flame

| | | | | |
|-----------|---|---------------|--|--------|
| VE2.100 D |   | 50 ... 100 kW |  | p. 164 |
| VE2.150 D |   | 65 ... 150 kW |  | p. 164 |



























ONE STAGE / Low NO_x, Blue Flame

| | | | | |
|--------|---|--------------|---|--------|
| VB1.20 |   | 11 ... 20 kW |  | p. 166 |
| VB1.24 |   | 14 ... 24 kW |  | p. 166 |
| VB1.28 |   | 20 ... 28 kW |  | p. 166 |
| VB1.30 |   | 22 ... 30 kW |  | p. 166 |
| VB1.35 |   | 25 ... 35 kW |  | p. 166 |







TWO STAGES PWM / Low NO_x, Blue Flame

| | | | | |
|-----------|---|--------------|---|--------|
| VB2.38 VD |   | 22 ... 38 kW |  | p. 168 |
| VB2.45 VD |   | 25 ... 45 kW |  | p. 168 |
| VB2.54 VD |   | 32 ... 54 kW |  | p. 168 |
| VB2.66 VD |   | 40 ... 66 kW |  | p. 168 |
| VB2.77 VD |   | 45 ... 77 kW |  | p. 170 |
| VB2.85 VD |   | 48 ... 85 kW |  | p. 170 |
| VB2.95 VD |   | 52 ... 95 kW |  | p. 170 |







TWO STAGES / Low NO_x, Blue Flame

| | | | | |
|------------|---|----------------|---|--------|
| VB30.120 D |   | 50 ... 120 kW |  | p. 172 |
| VB30.190 D |   | 68 ... 195 kW |  | p. 172 |
| VB30.230 D |   | 125 ... 240 kW |  | p. 172 |
| VB35.320 D |   | 120 ... 330 kW |  | p. 174 |
| VB35.370 D |   | 140 ... 375 kW |  | p. 174 |
| VB40.420 D |   | 135 ... 430 kW |  | p. 176 |
| VB40.460 D |   | 140 ... 470 kW |  | p. 176 |
| VB40.590 D |   | 230 ... 600 kW |  | p. 176 |
| VB45.810 D |   | 290 ... 825 kW |  | p. 176 |















TWO STAGE PROGRESSIVE/MODULATING ELECTRONIC / ULTRA Low NO_x

| | | | | |
|---------------------|---|-----------------|---|--------|
| EK EVO 4.800 L-EOT |  | 260 ... 870 kW |  | p. 178 |
| EK EVO 4.1000 L-EOT |  | 260 ... 1100 kW |  | p. 178 |
| EK EVO 5.1400 L-EOT |  | 500 ... 1450 kW |  | p. 178 |



























ONE STAGE with pre-heater

| | | | | |
|----------|---|--------------|--|--------|
| VL1.40 P |   | 18 ... 40 kW |  | p. 180 |
| VL1.55 P |   | 30 ... 55 kW |  | p. 180 |













ONE STAGE

| | | | | |
|---------|---|----------------|--|--------|
| VL1.42 |   | 20 ... 42 kW |  | p. 180 |
| VL1.55 |   | 30 ... 55 kW |  | p. 180 |
| VL1.105 |   | 45 ... 105 kW |  | p. 180 |
| VL2.140 |   | 80 ... 140 kW |  | p. 182 |
| VL2.200 |   | 130 ... 200 kW |  | p. 182 |

TWO STAGES

| | | | | |
|------------|---|-----------------|--|--------|
| VL2.120 D |   | 60 ... 120 kW |  | p. 184 |
| VL2.160 D |   | 80 ... 160 kW |  | p. 184 |
| VL2.210 D |   | 100 ... 210 kW |  | p. 184 |
| VL3.290 D |   | 130 ... 290 kW |  | p. 186 |
| VL3.360 D |   | 170 ... 360 kW |  | p. 186 |
| VL4.440 D |   | 180 ... 440 kW |  | p. 186 |
| VL4.460 D |  | 180 ... 460 kW |  | p. 188 |
| VL4.610 D |  | 195 ... 610 kW |  | p. 188 |
| VL5.950 D |  | 260 ... 950 kW |  | p. 190 |
| VL5.1200 D |  | 400 ... 1186 kW |  | p. 190 |

THREE STAGES

| | | | | |
|-------------|---|-----------------|--|--------|
| VL4.460 DP |  | 180 ... 460 kW |  | p. 192 |
| VL4.610 DP |  | 195 ... 610 kW |  | p. 192 |
| VL5.950 DP |  | 260 ... 950 kW |  | p. 194 |
| VL5.1200 DP |  | 400 ... 1186 kW |  | p. 194 |
| VL6.1600 DP |  | 320 ... 1600 kW |  | p. 196 |
| VL6.2100 DP |  | 400 ... 2080 kW |  | p. 196 |

| | |
|---|--------|
| Modulation kit | p. 198 |
| O₂/CO Trim | p. 200 |
| Kit LCM for BT3xx | p. 201 |
| Communication modules | p. 201 |
| Display | p. 201 |
| Remote software | p. 201 |
| MDE2 System | p. 201 |
| Cable for 0-10V load input | p. 201 |
| Front boiler flange | p. 201 |
| Sound proofing box | p. 202 |
| External air intake connection kit | p. 202 |
| External valve connection kit | p. 202 |
| Maximum gas pressure switch | p. 202 |
| Gas and air manometer with push button | p. 202 |
| Gas filter | p. 202 |
| Antivibration coupling - Compensator | p. 203 |
| Ball valve | p. 203 |
| Kit Variatron | p. 203 |
| Kit remote reset | p. 203 |
| Kit additional oil safety valve | p. 203 |
| "Flame on" digital output | p. 203 |

VG1.40 E / VG1.55 E / VG1.105 E

15 ... 105 kW
One stage



- **Fuels:** natural gas (G20/G25, $H_u = 8,83...10,35 \text{ kWh/m}^3$); LPG (G31, $H_u = 25,89 \text{ kWh/m}^3$)
- **Emissions:** $\text{NO}_x < 56 \text{ mg/kWh}$ (GCV), burners compliant with ErP Directive
- **Protection level:** IP 21

TECHNICAL DATA

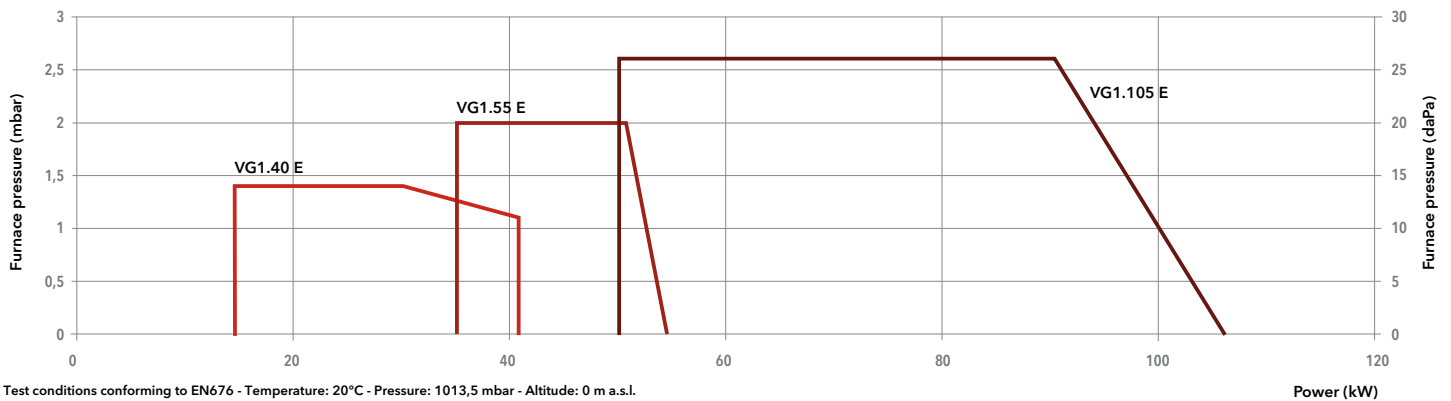

| Model | VG1.40 E /TC | | VG1.55 E /TC | | VG1.105 E /TC | | | |
|---|----------------------|------------------------------------|----------------------|----------------|----------------------|----------------|---------------------|---------------------|
| Operation range | 15 - 41 kW | | 35 - 55 kW | | 50 - 105 kW | | | |
| Gas pressure | 20 - 100 mbar | | 20 - 100 mbar | | 20 - 360 mbar | | | |
| Control box / flame detection | TCG1... / ionization | | TCG1... / ionization | | TCG1... / ionization | | | |
| Fan motor | 230 V - 50 Hz - 85 W | | 230 V - 50 Hz - 85 W | | 230 V - 50 Hz - 85 W | | | |
| Electrical consumption (min/max/stand-by) | 119 W / 137 W / 3 W | | 129 W / 131 W / 3 W | | 196 W / 212 W / 3 W | | | |
| Acoustic level (LpA) | 55 dB(A) | | 55 dB(A) | | 61 dB(A) | | | |
| CE certificate | 0476 CT 2423 | | 0476 CT 2423 | | 0476 CT 2423 | | | |
| Head length | KN | KL | KN | KL | KN | KL | | |
| Complete burner code | VR4625 MB-DLE 407 | h3/8"-Rp1/2"/TC d3/4"-Rp3/4"/TC | 3866346 | 3836506 | 3836347 | 3836517 | - 3836348 | - 3836518 |

OTHER AVAILABLE VERSIONS

- 60 60 Hz version
- Vent Versions for continuous ventilation and post-ventilation

SCOPE OF SUPPLY

The burner is delivered in its package complete with:

- 1 gas connection flange
- 1 compact gas train with gas filter; the gas filter is built-in for threaded valves (up to 2") and separated for flanged ones (DN65/80/100)
- 1 burner flange with insulation
- 1 bag containing installation fittings
- 1 bag containing technical documentation (instruction manual, technical data, electrical diagram, exploded view and spare parts list)



DIMENSIONS (mm)

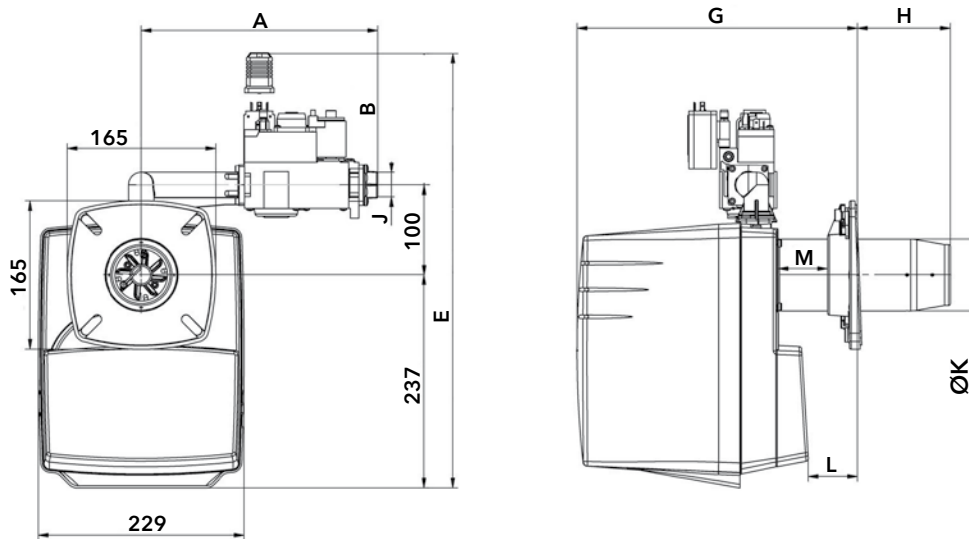

| Model | A | B | E | G | | H | | J | Ø K | L | | M |
|-------------|-----|-----|-----|-----------|-----------|----------|----------|--------|-----|-----|-----|----|
| | | | | KN | KL | KN | KL | | | min | max | |
| VG1.40/55 E | 263 | 147 | 484 | 297...337 | 297...387 | 70...110 | 70...200 | Rp1/2" | 80 | 21 | 61 | 48 |
| VG1.105 E | 282 | 140 | 477 | 300...355 | 300...390 | 70...138 | 70...228 | Rp3/4" | 90 | 15 | 83 | 52 |

Connecting flange

| Model | Øa (mm) | b (mm) | c | d |
|-------------|---------|---------|----|-----|
| VG1.40/55 E | 85-104 | 150-170 | M8 | 45° |
| VG1.105 E | 95-104 | 150-170 | M8 | 45° |

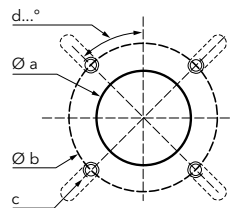

PACKAGING

The burner is delivered in a single package containing all the components

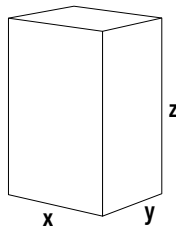

| Burner | Dimensions (mm) | | | Gross weight (kg) |
|-----------|-----------------|-----|-----|-------------------|
| | X | Y | Z | |
| VG1.40 E | 300 | 260 | 650 | 12 |
| VG1.55 E | 300 | 260 | 650 | 12 |
| VG1.105 E | 300 | 260 | 650 | 12 |

VG2.140 E / VG2.205 E

80 ... 205 kW
One stage



- **Fuels:** natural gas (G20/G25, $H_u = 8,83...10,35 \text{ kWh/m}^3$); LPG (G31, $H_u = 25,89 \text{ kWh/m}^3$)
- **Emissions:** $\text{NO}_x < 56 \text{ mg/kWh (GCV)}$, burners compliant with ErP Directive
- **Protection level:** IP 21

TECHNICAL DATA

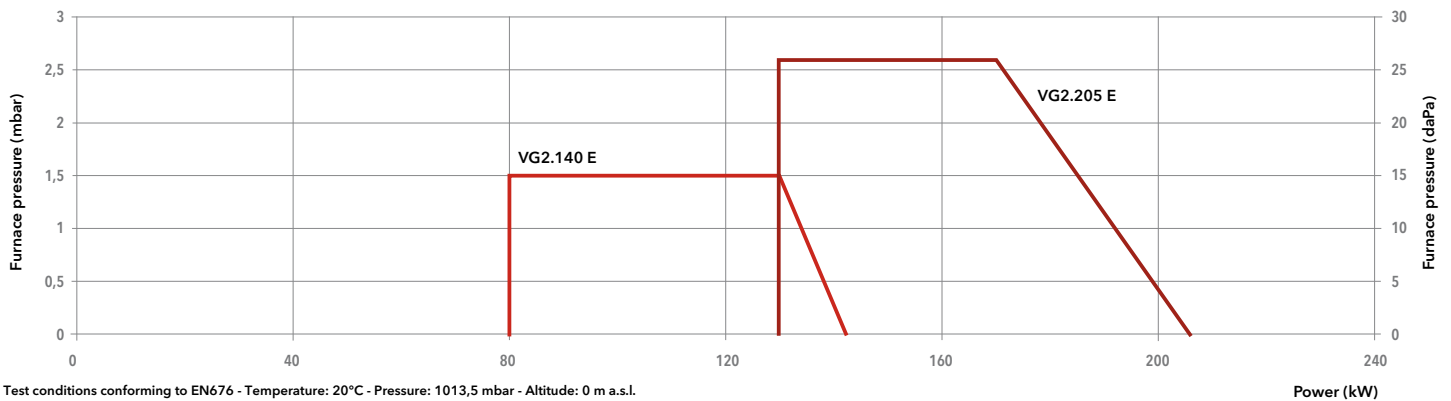

| Model | VG2.140 E | | VG2.205 E | |
|---|--------------------------|--------------------------------|-----------------------|--------------------|
| Operation range | 80 - 140 kW | | 130 - 205 kW | |
| Gas pressure | 20 - 360 mbar | | 20 - 360 mbar | |
| Control box / flame detection | TCG1... / ionization | | TCG1... / ionization | |
| Fan motor | 230 V - 50 Hz - 100 W | | 230 V - 50 Hz - 130 W | |
| Electrical consumption (max/min/stand-by) | 270 W / 230 W / 3 W | | 302 W / 267 W / 3 W | |
| Acoustic level (LpA) | 62 dB(A) | | 65 dB(A) | |
| CE certificate | 0476 CT 2423 | | 0476 CT 2423 | |
| Head length | KN | KL | KN | KL |
| Complete burner code | MB-DLE 412 MB-DLE 407 | d1"1/4-Rp1"1/4 d3/4"-Rp3/4" | 3836351 3836353 | 3836352 3836354 |

OTHER AVAILABLE VERSIONS

- 60 60 Hz version
- Vent Versions for continuous ventilation and post-ventilation

SCOPE OF SUPPLY

The burner is delivered in its package complete with:

- 1 gas connection flange
- 1 compact gas train with gas filter; the gas filter is built-in for threaded valves (up to 2") and separated for flanged ones (DN65/80/100)
- 1 burner flange with insulation
- 1 bag containing installation fittings
- 1 bag containing technical documentation (instruction manual, technical data, electrical diagram, exploded view and spare parts list)

DIMENSIONS (mm)

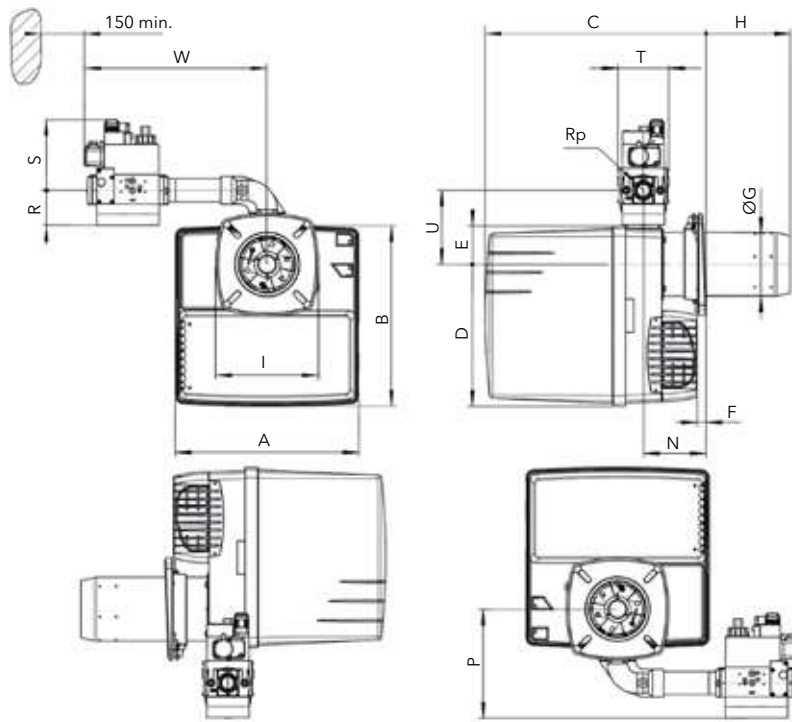

| Model | Gas train | A | B | C | | D | E | F min | ØG | H | | I | N min | P | Rp | R | S | T | U | W |
|---------|----------------|-----|-----|-----------|-----------|-----|----|-------|-----|----------|----------|-----|-------|-----|-------|----|-----|-----|-----|-----|
| | | | | KN | KL | | | | | KN | KL | | | | | | | | | |
| VG2.140 | d3/4"-Rp3/4" | 331 | 325 | 398...518 | 398...638 | 256 | 69 | 15 | 115 | 30...150 | 30...270 | 185 | 113 | 179 | 3/4" | 70 | 140 | 120 | 133 | 345 |
| VG2.205 | d3/4"-Rp3/4" | 331 | 325 | 398...518 | 398...638 | 256 | 69 | 15 | 125 | 30...150 | 30...270 | 185 | 113 | 179 | 3/4" | 70 | 140 | 120 | 133 | 345 |
| VG2.205 | d1"1/4-Rp1"1/4 | 331 | 325 | 398...518 | 398...638 | 256 | 69 | 15 | 125 | 30...150 | 30...270 | 185 | 113 | 188 | 1"1/4 | 80 | 160 | 145 | 133 | 380 |

Connecting flange

| Model | Øa (mm) | b (mm) | c | d |
|---------|---------|---------|----|-----|
| VG2.140 | 120-135 | 150-185 | M8 | 45° |
| VG2.205 | 130-145 | 160-185 | M8 | 45° |

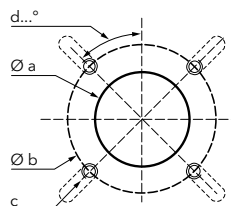

PACKAGING

The burner is delivered in a single package containing all the components

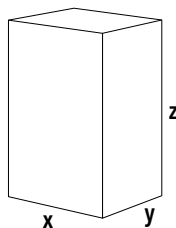

| Burner | Dimensions (mm) | | | Gross weight (kg) |
|---------|-----------------|-----|-----|-------------------|
| | X | Y | Z | |
| VG2.140 | 400 | 400 | 760 | 25 |
| VG2.205 | 400 | 400 | 760 | 25 |

VG1.105 D E

37 ... 105 kW
Two stages

- **Fuels:** natural gas (G20/G25, $H_u = 8,83 \dots 10,35 \text{ kWh/m}^3$);
LPG (G31, $H_u = 25,89 \text{ kWh/m}^3$)
- **Emissions:** $\text{NO}_x < 56 \text{ mg/kWh}$ (GCV), burners compliant with ErP Directive
- **Protection level:** IP 21



TECHNICAL DATA

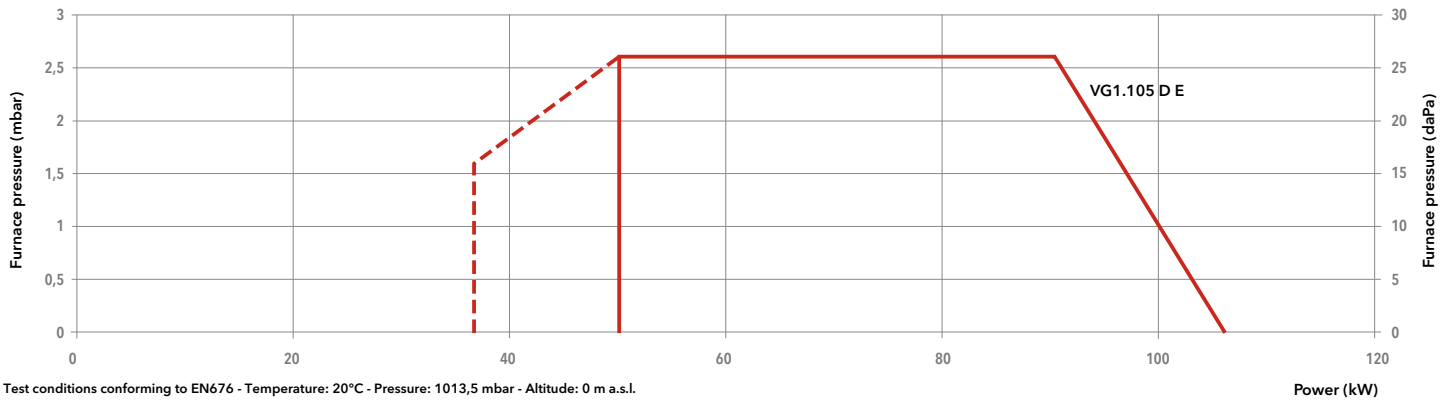

| Model | VG1.105 D | |
|---|--|----------------|
| Operation range | (37) 50 - 105 kW | |
| Gas pressure | 20 - 360 mbar | |
| Flame detection | Ionization | |
| Fan motor | 230 V - 50 Hz - 85 W | |
| Electrical consumption (max/min/stand-by) | 205 W / 200 W / 3 W | |
| Acoustic level (LpA) | 60,5 dB(A) | |
| CE certificate | 0476 CT 2423 | |
| Head length | KN | KL |
| Complete burner code | MB-ZRDLE 407 d3/4"-Rp3/4" 3836355 | 3836519 |

OTHER AVAILABLE VERSIONS

- 60 60 Hz version
- V_{ent} Versions for continuous ventilation and post-ventilation

SCOPE OF SUPPLY

The burner is delivered in its package complete with:

- 1 gas connection flange
- 1 compact gas train with gas filter; the gas filter is built-in for threaded valves (up to 2") and separated for flanged ones (DN65/80/100)
- 1 burner flange with insulation
- 1 bag containing installation fittings
- 1 bag containing technical documentation (instruction manual, technical data, electrical diagram, exploded view and spare parts list)



DIMENSIONS (mm)

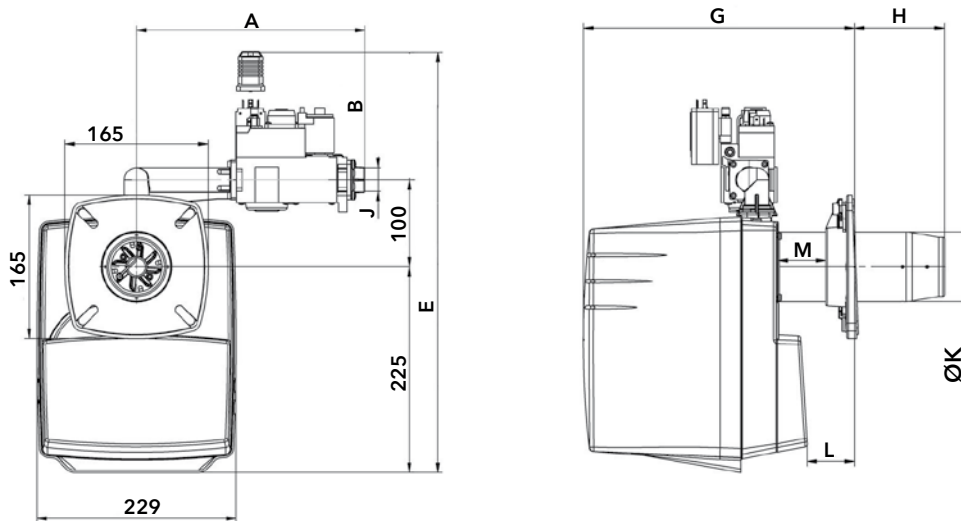

| A | B | E | G | | H | | J | ØK | L | | M |
|-----|-----|-----|-----------|-----------|----------|----------|--------|----|-----|-----|----|
| | | | KN | KL | KN | KL | | | min | max | |
| 290 | 310 | 535 | 300...355 | 300...390 | 70...138 | 70...228 | Rp3/4" | 90 | 15 | 83 | 52 |

Connecting flange

| Øa (mm) | b (mm) | c | d |
|---------|---------|----|-----|
| 95-104 | 150-170 | M8 | 45° |

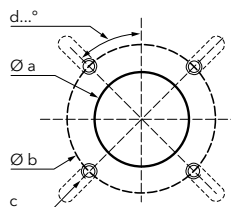

PACKAGING

The burner is delivered in a single package containing all the components

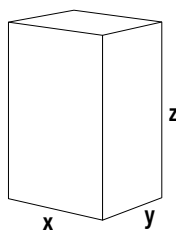

| Dimensions (mm) | | | Gross weight (kg) |
|-----------------|-----|-----|-------------------|
| X | Y | Z | |
| 300 | 260 | 650 | 12 |

VG2.120 D E / VG2.160 D E / VG2.205 D E

40 ... 205 kW
Two stages

- **Fuels:** natural gas (G20/G25, $H_u = 8,83...10,35 \text{ kWh/m}^3$); LPG (G31, $H_u = 25,89 \text{ kWh/m}^3$)
- **Emissions:** $\text{NO}_x < 56 \text{ mg/kWh}$ (GCV), burners compliant with ErP Directive
- **Protection level:** IP 21



TECHNICAL DATA

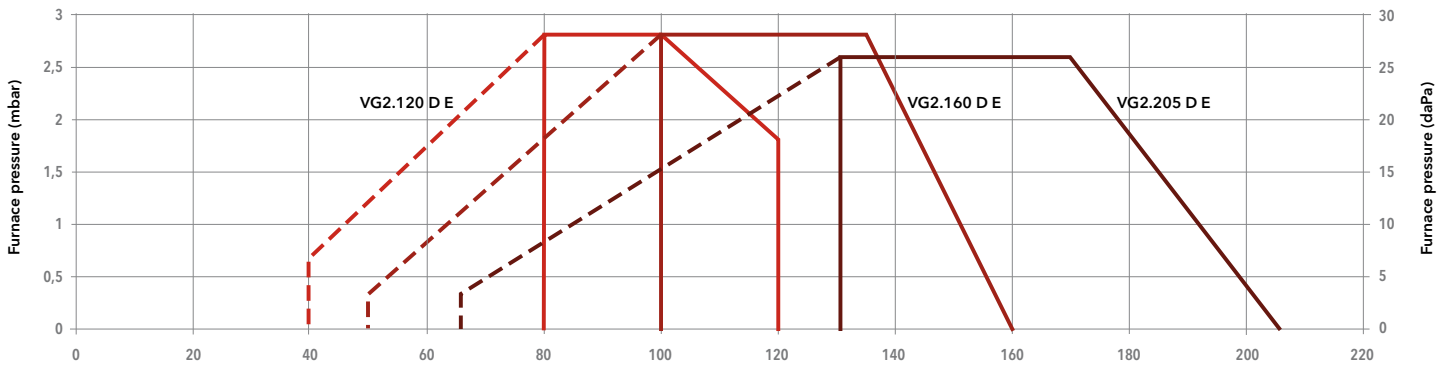

Test conditions conforming to EN676 - Temperature: 20°C - Pressure: 1013,5 mbar - Altitude: 0 m a.s.l.

| Model | VG2.120 D E | | VG2.160 D E | | VG2.205 D E | |
|---|-----------------------------|----------------|-----------------------------|----------------|-----------------------------|----------------|
| Operation range | (40) 80 - 120 kW | | (50) 100 - 160 kW | | (60) 130 - 205 kW | |
| Gas pressure | 20 - 360 mbar | | 20 - 360 mbar | | 20 - 360 mbar | |
| Control box / flame detection | TCG2... / ionization | | TCG2... / ionization | | TCG2... / ionization | |
| Fan motor | 230 V - 50 Hz - 100 W | | 230 V - 50 Hz - 100 W | | 230 V - 50 Hz - 130 W | |
| Electrical consumption (min/max/stand-by) | 239 W / 358 W / 4 W | | 285 W / 293 W / 4 W | | 302 W / 267 W / 4 W | |
| Acoustic level (LpA) | 62 dB(A) | | 64 dB(A) | | 65 dB(A) | |
| CE certificate | 0476 CT 2423 | | 0476 CT 2423 | | 0476 CT 2423 | |
| Head length | KN | KL | KN | KL | KN | KL |
| Complete burner code | MB-ZRDLE 412 d1"1/4-Rp1"1/4 | - | MB-ZRDLE 412 d1"1/4-Rp1"1/4 | - | MB-ZRDLE 412 d1"1/4-Rp1"1/4 | - |
| Complete burner code | MB-ZRDLE 407 d3/4"-Rp3/4" | 3836356 | MB-ZRDLE 407 d3/4"-Rp3/4" | 3836357 | MB-ZRDLE 407 d3/4"-Rp3/4" | 3836358 |
| Complete burner code | | | | | 3836359 | 3836360 |
| Complete burner code | | | | | 3836362 | 3836361 |
| Complete burner code | | | | | 3836363 | 3836363 |

OTHER AVAILABLE VERSIONS

- 60 60 Hz version
- Ver Versions for continuous ventilation and post-ventilation

SCOPE OF SUPPLY

The burner is delivered in its package complete with:

- 1 gas connection flange
- 1 compact gas train with gas filter; the gas filter is built-in for threaded valves (up to 2") and separated for flanged ones (DN65/80/100)
- 1 burner flange with insulation
- 1 bag containing installation fittings
- 1 bag containing technical documentation (instruction manual, technical data, electrical diagram, exploded view and spare parts list)



DIMENSIONS (mm)

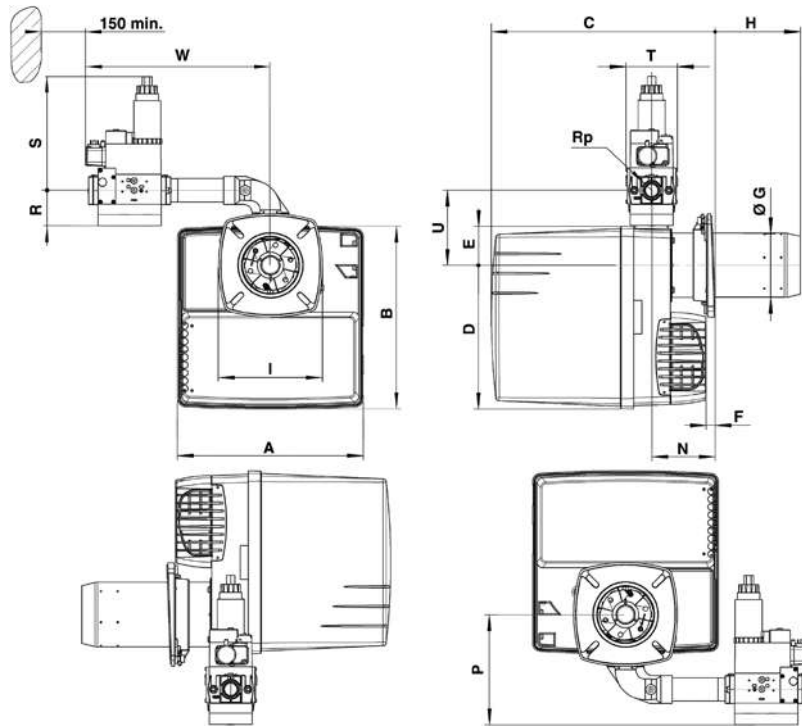

| Model | Gas train | A | B | C | | D | E | F min | ØG | H | | I | N min | P | Rp | R | S | T | U | W |
|---------|----------------|-----|-----|-----------|-----------|-----|----|-------|-----|----------|----------|-----|-------|-----|-------|----|-----|-----|-----|-----|
| | | | | KN | KL | | | | | KN | KL | | | | | | | | | |
| VG2.120 | d3/4"-Rp3/4" | 331 | 325 | 398...518 | 398...638 | 256 | 69 | 15 | 115 | 30...150 | 30...270 | 185 | 113 | 179 | 3/4" | 46 | 210 | 120 | 133 | 330 |
| VG2.160 | d3/4"-Rp3/4" | 331 | 325 | 398...518 | 398...638 | 256 | 69 | 15 | 115 | 30...150 | 30...270 | 185 | 113 | 179 | 3/4" | 46 | 210 | 120 | 133 | 330 |
| VG2.205 | d3/4"-Rp3/4" | 331 | 325 | 398...518 | 398...638 | 256 | 69 | 15 | 125 | 30...150 | 30...270 | 185 | 113 | 179 | 3/4" | 46 | 210 | 120 | 133 | 330 |
| | d1"1/4-Rp1"1/4 | 331 | 325 | 398...518 | 398...638 | 256 | 69 | 15 | 125 | 30...150 | 30...270 | 185 | 113 | 188 | 1"1/4 | 55 | 260 | 145 | 133 | 360 |

Connecting flange

| Model | Øa (mm) | b (mm) | c | d |
|-------------|---------|---------|----|-----|
| VG2.120/160 | 120-135 | 150-185 | M8 | 45° |
| VG2.205 | 130-145 | 160-185 | M8 | 45° |

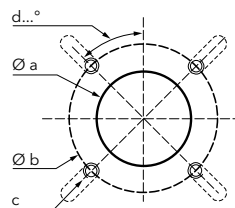

PACKAGING

The burner is delivered in a single package containing all the components

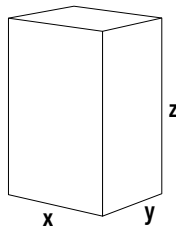

| Burner | Dimensions (mm) | | | Gross weight (kg) |
|---------|-----------------|-----|-----|-------------------|
| | X | Y | Z | |
| VG2.120 | 400 | 400 | 760 | 26 |
| VG2.160 | 400 | 400 | 760 | 26 |
| VG2.205 | 400 | 400 | 760 | 26 |

VG3.290 D E / VG3.350 D E

95 ... 350 kW

Two stages

- **Fuels:** natural gas (G20/G25, $H_u = 8,83...10,35 \text{ kWh/m}^3$); LPG (G31, $H_u = 25,89 \text{ kWh/m}^3$)
- **Emissions:** $\text{NO}_x < 56 \text{ mg/kWh}$ (GCV), burners compliant with ErP Directive
- **Protection level:** IP 21



TECHNICAL DATA

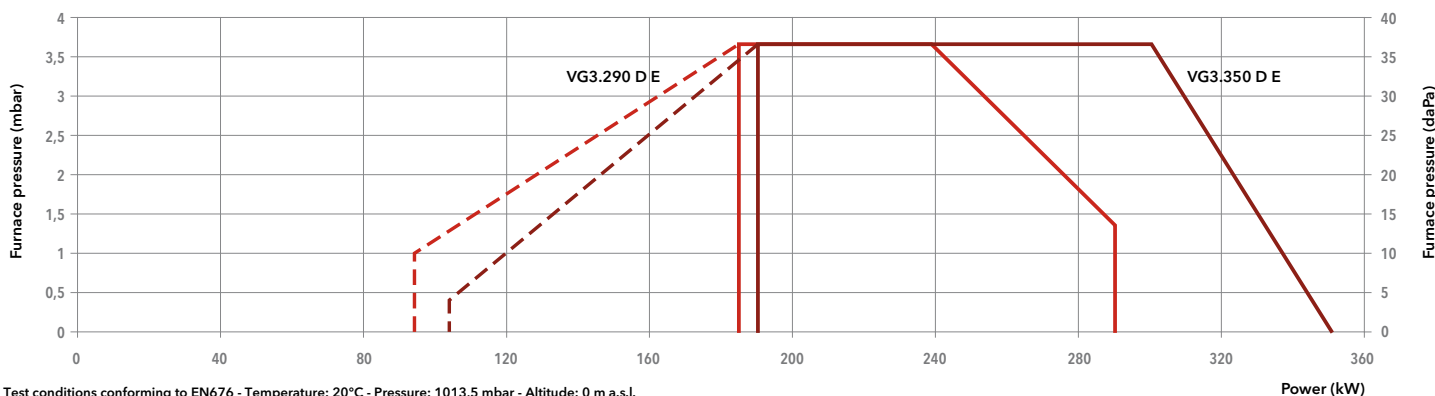

| Model | VG3.290 D E | | VG3.350 D E | |
|---|-----------------------------|---------|-----------------------|---------|
| Operation range | (95) 185 - 290 kW | | (105) 190 - 350 kW | |
| Gas pressure | 20 - 360 mbar | | 20 - 360 mbar | |
| Control box / flame detection | TCG2... / ionization | | TCG2... / ionization | |
| Fan motor | 230 V - 50 Hz - 250 W | | 230 V - 50 Hz - 300 W | |
| Electrical consumption (max/min/stand-by) | 465 W / 441 W / 4 W | | 583 W / 583 W / 4 W | |
| Acoustic level (LpA) | 67 dB(A) | | 69 dB(A) | |
| CE certificate | 0476 CT 2423 | | 0476 CT 2423 | |
| Head length | KN | KL | KN | KL |
| Complete burner code | MB-ZRDLE 420 d1"1/2-Rp2" | - | 3836382 | 3836383 |
| | MB-ZRDLE 412 d1"1/4-Rp1"1/4 | 3836378 | 3836384 | 3836385 |
| | MB-ZRDLE 407 d3/4"-Rp3/4" | 3836380 | 3836381 | 3836386 |

OTHER AVAILABLE VERSIONS

- 60 60 Hz version
- TC Version with tightness control
- V_{vent} Versions for continuous ventilation and post-ventilation

SCOPE OF SUPPLY

The burner is delivered in its package complete with:

- 1 burner head with flange seal and securing screws
- 1 compact gas train with gas filter; the gas filter is built-in for threaded valves (up to 2") and separated for flanged ones (DN65/80/100)
- 1 bag containing installation fittings
- 1 bag containing technical documentation (instruction manual, technical data, electrical diagram, exploded view and spare parts list)



DIMENSIONS (mm)

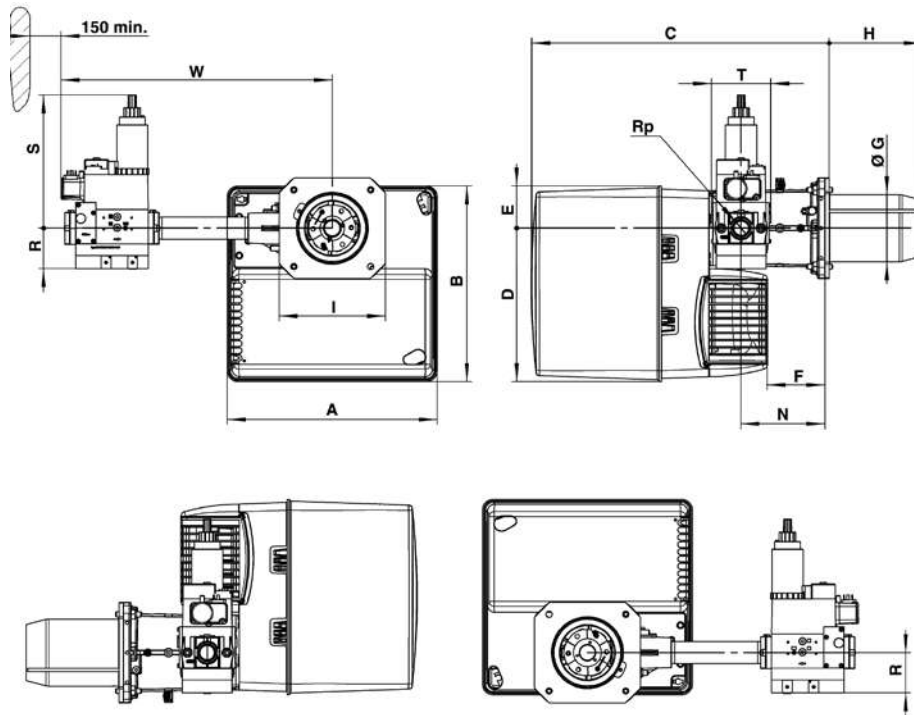

| Gas train model | A | B | C | D | E | F | ØG | H | | I | N | Rp | R | S | T | W |
|-----------------|-----|-----|-----|-----|----|-----|-----|-----|-----|---------|-----|-------|----|-----|-----|-----|
| | | | | | | | | KN | KL | | | | | | | |
| d1"1/2-Rp2" | 406 | 379 | 576 | 297 | 82 | 120 | 130 | 180 | 320 | 195x205 | 170 | 2" | 80 | 330 | 100 | 603 |
| d1"1/4-Rp1"1/4 | 406 | 379 | 576 | 297 | 82 | 120 | 130 | 180 | 320 | 195x205 | 170 | 1"1/4 | 55 | 260 | 145 | 526 |
| d3/4"-Rp3/4" | 406 | 379 | 576 | 297 | 82 | 120 | 130 | 180 | 320 | 195x205 | 170 | 3/4" | 46 | 210 | 120 | 479 |

Connecting flange

| Øa (mm) | b (mm) | c | d |
|---------|---------|-----|-----|
| 155-190 | 175-220 | M10 | 45° |

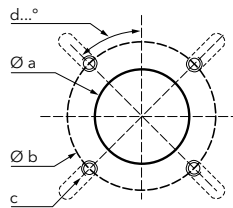

PACKAGING

The burner is delivered on a pallet in three packages containing:

- burner housing
- combustion head
- gas train and filter

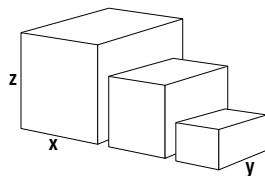

| Component | | Dimensions (mm) | | | Gross weight (kg) |
|-----------------|----------------|-----------------|-----|-----|-------------------|
| | | X | Y | Z | |
| Burner body | VG3.290 D E | 440 | 400 | 520 | 21 |
| | VG3.350 D E | 440 | 400 | 520 | 21 |
| Combustion head | KN | 650 | 210 | 260 | 6 |
| | KL | 650 | 210 | 260 | 6 |
| Gas train | d1"1/2-Rp2" | 600 | 400 | 240 | 14 |
| | d1"1/4-Rp1"1/4 | 440 | 320 | 240 | 10 |
| | d3/4"-Rp3/4" | 440 | 320 | 240 | 7 |

VG3.290 D E / VG3.350 D E

95 ... 350 kW
Two stages

PRESSURE LOSS [BURNER HEAD + GAS TRAIN] (mbar)

VG3.290 D E

| Burner output (kW) | Natural gas G20 Hi = 10,35 kWh/m ³ | | Natural gas G25 Hi = 8,83 kWh/m ³ | | LPG G31 Hi = 25,89 kWh/m ³ | |
|--------------------|---|----------------|--|----------------|---------------------------------------|----------------|
| | d3/4"-Rp3/4" | d1"1/4-Rp1"1/4 | d3/4"-Rp3/4" | d1"1/4-Rp1"1/4 | d3/4"-Rp3/4" | d1"1/4-Rp1"1/4 |
| 190 | 22 | 10 | 29 | 12 | 13 | 7 |
| 210 | 24 | 10 | 33 | 13 | 14 | 7 |
| 230 | 27 | 11 | 38 | 15 | 15 | 7 |
| 250 | 31 | 12 | 43 | 16 | 16 | 7 |
| 270 | 36 | 14 | 49 | 18 | 18 | 8 |
| 290 | 41 | 15 | 56 | 20 | 21 | 9 |

Natural gas G20

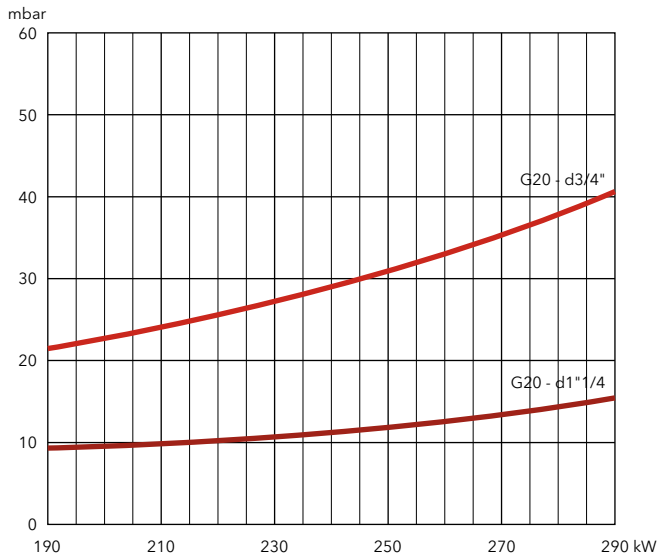

Natural gas G25

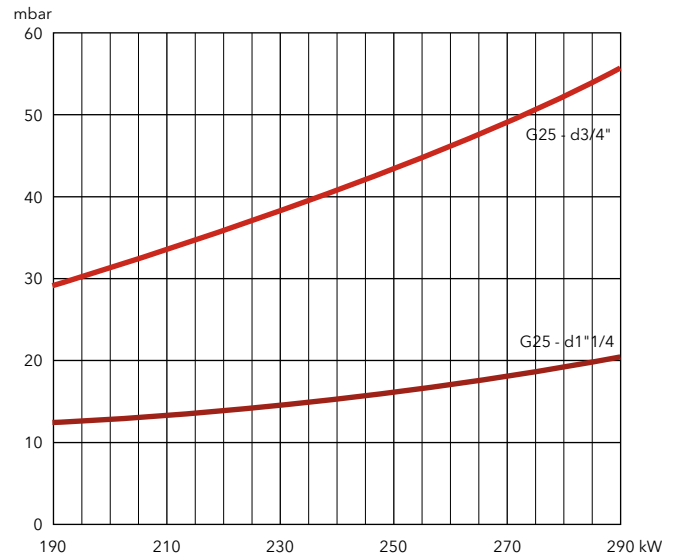

LPG

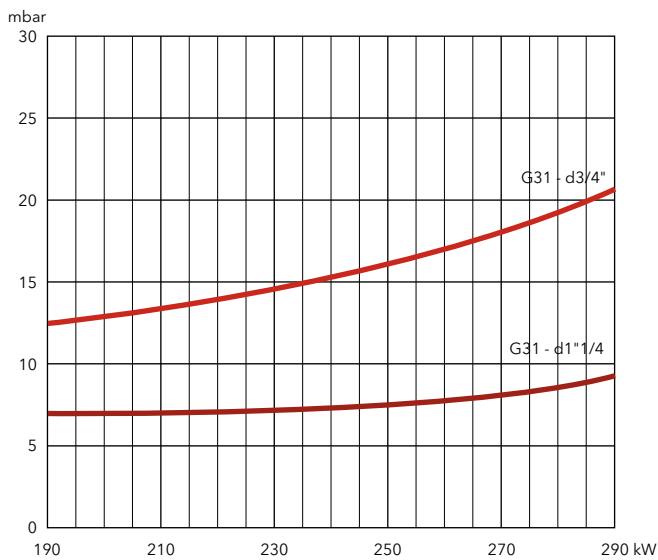



PRESSURE LOSS [BURNER HEAD + GAS TRAIN] (mbar)

VG3.350 D E

| Burner output (kW) | Natural gas G20 Hi = 10,35 kWh/m ³ | | Natural gas G25 Hi = 8,83 kWh/m ³ | | | LPG G31 Hi = 25,89 kWh/m ³ |
|--------------------|---|----------------|--|----------------|-------------|---------------------------------------|
| | d3/4"-Rp3/4" | d1"1/4-Rp1"1/4 | d3/4"-Rp3/4" | d1"1/4-Rp1"1/4 | d1"1/2-Rp2" | d3/4"-Rp3/4" |
| 190 | 18 | 7 | 27 | 10 | 8 | 10 |
| 230 | 25 | 9 | 38 | 14 | 9 | 14 |
| 270 | 33 | 12 | 49 | 18 | 12 | 18 |
| 310 | 43 | 14 | 62 | 23 | 14 | 23 |
| 350 | 53 | 18 | 77 | 28 | 19 | 28 |

Natural gas G20

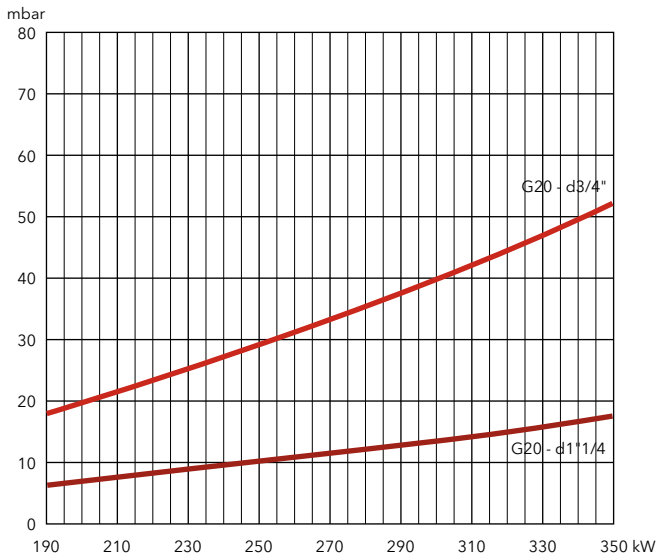

Natural gas G25

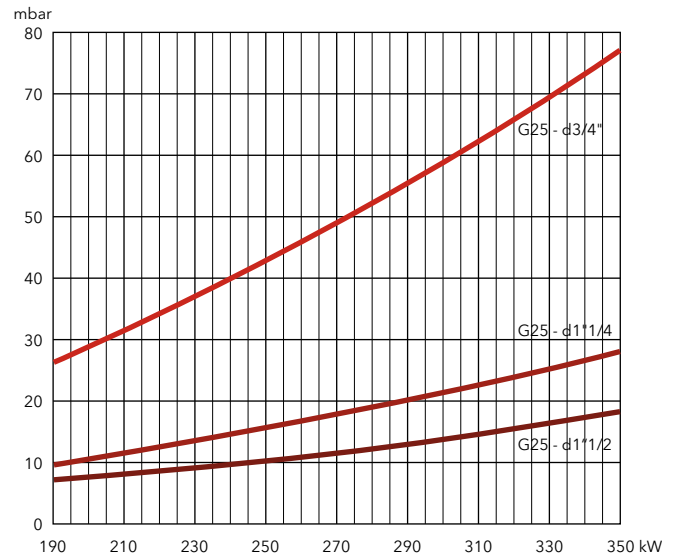

LPG

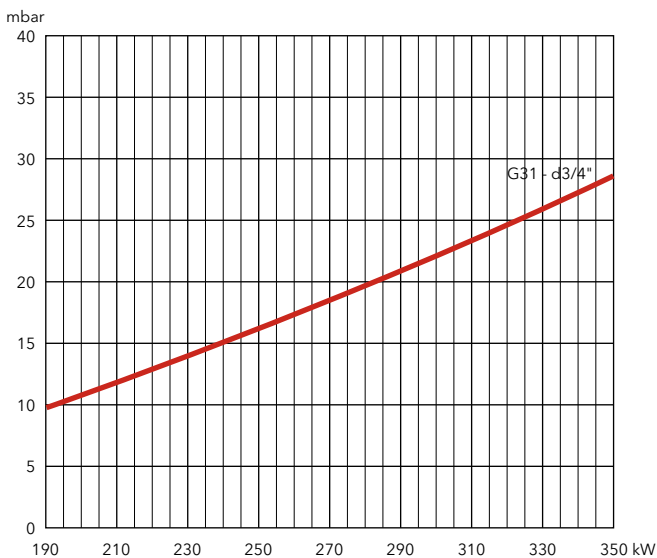

VG4.440 D E

110 ... 440 kW
Two stages

- **Fuels:** natural gas (G20/G25, $H_u = 8,83...10,35 \text{ kWh/m}^3$); LPG (G31, $H_u = 25,89 \text{ kWh/m}^3$)
- **Emissions:** $\text{NO}_x < 56 \text{ mg/kWh (GCV)}$, burners compliant with ErP Directive
- **Protection level:** IP 21



TECHNICAL DATA

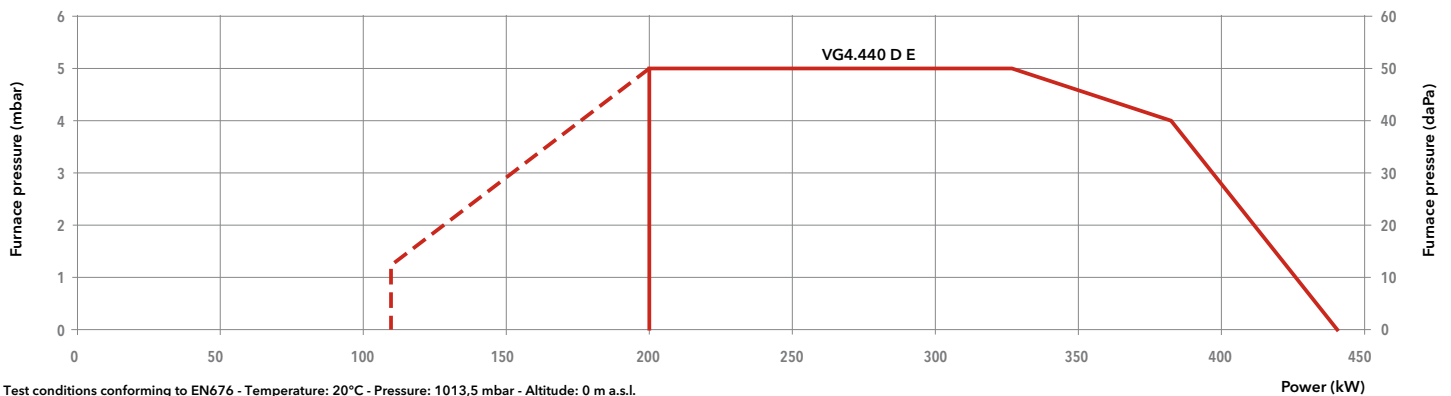

| Model | | VG4.440 D E | |
|---|-----------------------------|-----------------------|---------|
| Operation range | | (110) 200 - 440 kW | |
| Gas pressure | | 20 - 360 mbar | |
| Control box / flame detection | | TCG2.../ionization | |
| Fan motor | | 230 V - 50 Hz - 420 W | |
| Electrical consumption (max/min/stand-by) | | 606 W / 569 W / 4 W | |
| Acoustic level (LpA) | | 70 dB(A) | |
| CE certificate | | 0476 CT 2423 | |
| Head length | | KN | KL |
| Complete burner code | MB-ZRDLE 420 d1"1/2-Rp2" | 3836398 | 3836399 |
| | MB-ZRDLE 412 d1"1/4-Rp1"1/4 | 3836400 | 3836401 |
| | MB-ZRDLE 407 d3/4"-Rp3/4" | 3836402 | 3836403 |

OTHER AVAILABLE VERSIONS

- 60 60 Hz version
- TC Version with tightness control
- V_{vent} Versions for continuous ventilation and post-ventilation

SCOPE OF SUPPLY

The burner is delivered in its package complete with:

- 1 burner head with flange seal and securing screws
- 1 compact gas train with gas filter; the gas filter is built-in for threaded valves (up to 2") and separated for flanged ones (DN65/80/100)
- 1 bag containing installation fittings
- 1 bag containing technical documentation (instruction manual, technical data, electrical diagram, exploded view and spare parts list)



DIMENSIONS (mm)

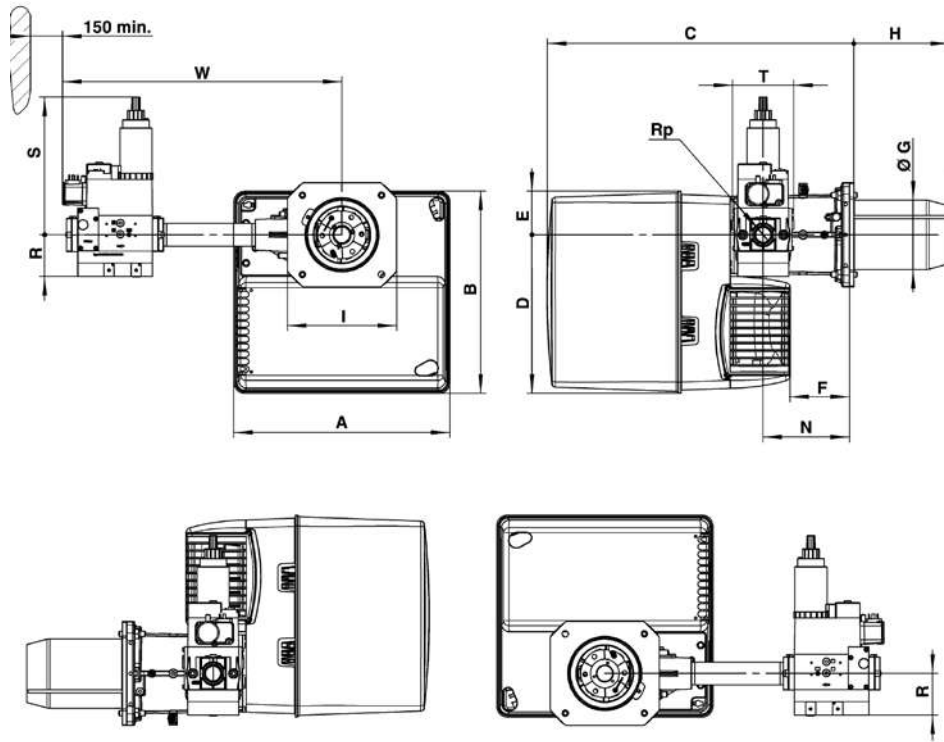

| Gas train model | A | B | C | D | E | F | ØG | H | | I | N | Rp | R | S | T | W |
|-----------------|-----|-----|-----|-----|----|-----|-----|-----|-----|-----|-----|-------|----|-----|-----|-----|
| | | | | | | | | KN | KL | | | | | | | |
| d1"1/2-Rp2" | 465 | 475 | 640 | 377 | 97 | 149 | 157 | 212 | 352 | 245 | 195 | 2" | 80 | 330 | 100 | 613 |
| d1"1/4-Rp1"1/4 | 465 | 475 | 640 | 377 | 97 | 149 | 157 | 212 | 352 | 245 | 195 | 1"1/4 | 55 | 260 | 145 | 536 |
| d3/4"-Rp3/4" | 465 | 475 | 640 | 377 | 97 | 149 | 157 | 212 | 352 | 245 | 195 | 3/4" | 46 | 210 | 120 | 489 |

Connecting flange

| Øa (mm) | b (mm) | c | d |
|---------|---------|-----|-----|
| 190-240 | 200-270 | M10 | 45° |

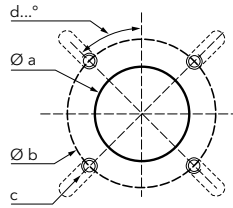

PACKAGING

The burner is delivered on a pallet in three packages containing:

- burner housing
- combustion head
- gas train and filter

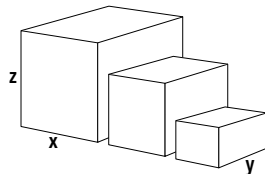

| Component | | Dimensions (mm) | | | Gross weight (kg) |
|-----------------|----------------|-----------------|-----|-----|-------------------|
| | | X | Y | Z | |
| Burner body | VG4.440 D E | 490 | 490 | 590 | 28,7 |
| | KN | 750 | 260 | 295 | 8,9 |
| Combustion head | KL | 895 | 260 | 295 | 10,1 |
| | d1"1/2-Rp2" | 600 | 400 | 240 | 14 |
| Gas train | d1"1/4-Rp1"1/4 | 440 | 320 | 240 | 10 |
| | d3/4"-Rp3/4" | 440 | 320 | 240 | 7 |

VG4.440 D E

110 ... 440 kW
Two stages

PRESSURE LOSS [BURNER HEAD + GAS TRAIN] (mbar)

VG4.440 D E

| Burner output (kW) | Natural gas G20 Hi = 10,35 kWh/m ³ | | | Natural gas G25 Hi = 8,83 kWh/m ³ | | |
|--------------------|---|----------------|-------------|--|----------------|-------------|
| | d3/4"-Rp3/4" | d1"1/4-Rp1"1/4 | d1"1/2-Rp2" | d3/4"-Rp3/4" | d1"1/4-Rp1"1/4 | d1"1/2-Rp2" |
| 240 | 27 | 9 | 6 | 39 | 13 | 9 |
| 280 | 35 | 12 | 6 | 50 | 16 | 10 |
| 320 | 43 | 14 | 7 | 62 | 20 | 11 |
| 360 | 53 | 17 | 9 | 76 | 24 | 14 |
| 400 | 64 | 20 | 11 | 91 | 29 | 17 |
| 440 | 76 | 24 | 13 | 107 | 34 | 19 |

Natural gas G20

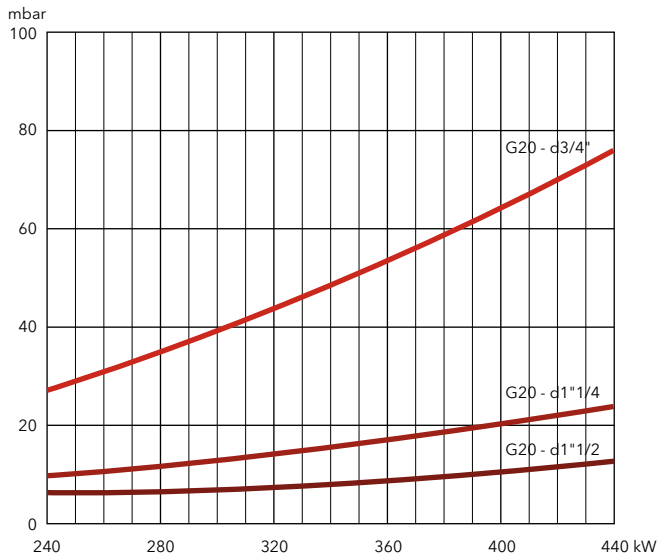

Natural gas G25

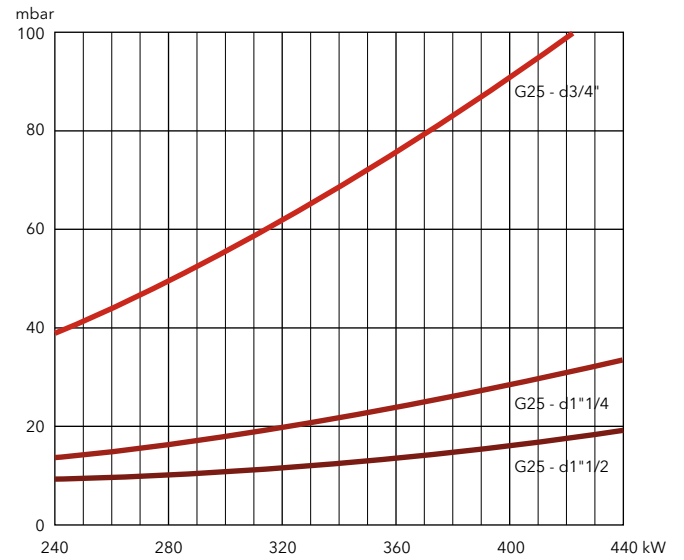



PRESSURE LOSS [BURNER HEAD + GAS TRAIN] (mbar)

VG4.440 D E

| Burner output (kW) | LPG G31 Hi = 25,89 kWh/m ³ | |
|--------------------|---------------------------------------|----------------|
| | d3/4"-Rp3/4" | d1"1/4-Rp1"1/4 |
| 240 | 16 | 8 |
| 280 | 20 | 9 |
| 320 | 24 | 10 |
| 360 | 29 | 12 |
| 400 | 35 | 15 |
| 440 | 42 | 18 |

LPG

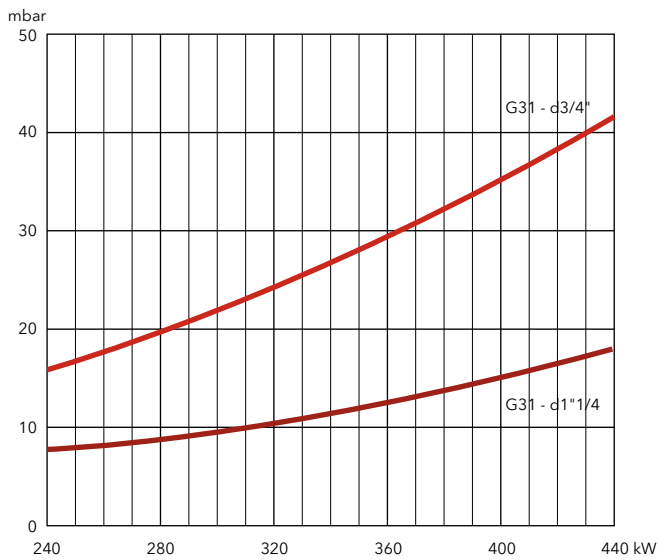

VG4.460 D

150 ... 460 kW
2 stages

- **Fuels:** natural gas, net calorific value 8,83...10,35 kWh/m³;
LPG, net calorific value 25,89 kWh/m³
- **Emissions:** NOx < 70 mg/kWh (NCV), Low NOx class 3 burners according to EN676
- **Protection level:** IP 41



TECHNICAL DATA

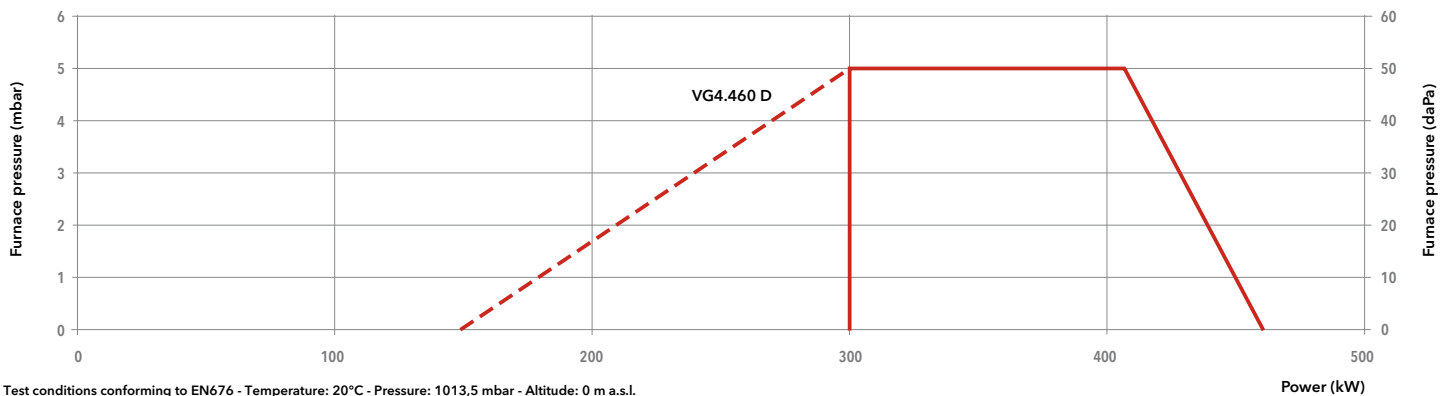

| Model | | VG 4.460 D | |
|-------------------------------|------------------------------|-----------------------|---------|
| Operation range | | (150) 300 - 460 kW | |
| Gas pressure | | 20 - 300 mbar | |
| Control box / flame detection | | TCG2... / ionization | |
| Fan motor | | 230 V - 50 Hz - 420 W | |
| Electrical consumption | | 595 W | |
| Acoustic level (LpA) | | 70 dB(A) | |
| CE certificate | | 1312 CL 5412 | |
| Head length | | KN | KL |
| Complete burner code | MB-ZRDLE 420 d1"1/2-Rp2" | 3833399 | 3833400 |
| | MB-ZRDLE 412 d1"1/4-Rp1"1/4" | 3833401 | 3833402 |
| | MB-ZRDLE 407 d3/4"-Rp3/4" | 3833403 | 3833404 |

OTHER AVAILABLE VERSIONS

- 60 60 Hz version
- TC Version with tightness control
- V_{vent} Versions for continuous ventilation and post-ventilation

SCOPE OF SUPPLY

The burner is delivered in its package complete with:

- 1 burner head with flange seal and securing screws
- 1 compact gas train with gas filter
- 1 bag containing installation fittings
- 1 bag containing technical documentation (instruction manual, technical data, electrical diagram, exploded view and spare parts list)



DIMENSIONS (mm)

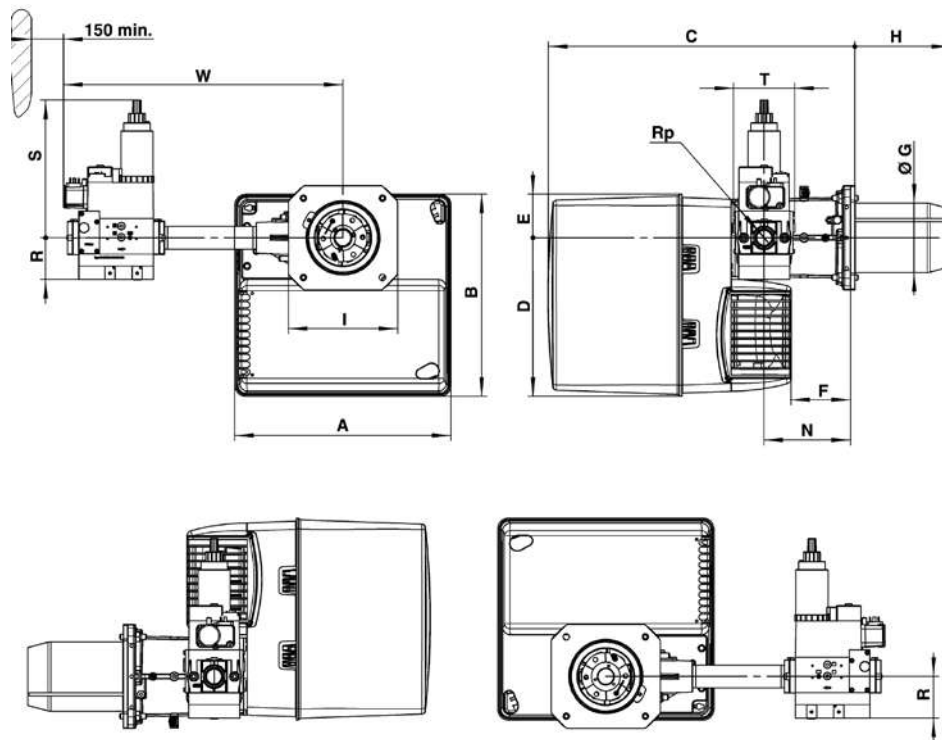

| Gas train model | A | B | C | D | E | F | ØG | H | | I | N | Rp | R | S | T | W |
|-----------------|-----|-----|-----|-----|----|-----|-----|-----|-----|-----|-----|-------|----|-----|-----|-----|
| | | | | | | | | KN | KL | | | | | | | |
| d1"1/2-Rp2" | 465 | 475 | 640 | 377 | 97 | 149 | 150 | 220 | 360 | 245 | 195 | 2" | 80 | 330 | 100 | 613 |
| d1"1/4-Rp1"1/4 | 465 | 475 | 640 | 377 | 97 | 149 | 150 | 220 | 360 | 245 | 195 | 1"1/4 | 55 | 260 | 145 | 536 |
| d3/4"-Rp3/4" | 465 | 475 | 640 | 377 | 97 | 149 | 150 | 220 | 360 | 245 | 195 | 3/4" | 46 | 210 | 120 | 489 |

Connecting flange

| Øa (mm) | b (mm) | c | d |
|---------|---------|-----|-----|
| 180-240 | 200-270 | M10 | 45° |

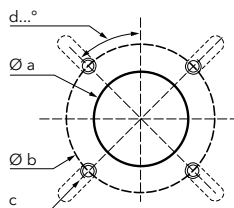

PACKAGING

The burner is delivered on a pallet in three packages containing:

- burner housing
- combustion head
- gas train and filter

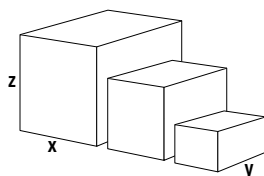

| Component | | Dimensions (mm) | | | Gross weight (kg) |
|-----------------|----------------|-----------------|-----|-----|-------------------|
| | | X | Y | Z | |
| Burner body | VG 4.460 D | 490 | 490 | 590 | 28,7 |
| Combustion head | KN | 750 | 260 | 295 | 8,9 |
| | KL | 895 | 260 | 295 | 10,1 |
| Gas train | d1"1/2-Rp2" | 600 | 400 | 240 | 14 |
| | d1"1/4-Rp1"1/4 | 440 | 320 | 240 | 10 |
| | d3/4"-Rp3/4" | 440 | 320 | 240 | 7 |

VG4.460 D

150 ... 460 kW
2 stages

PRESSURE LOSS [BURNER HEAD + GAS TRAIN] (mbar)

VG 4.460 D

| Burner output (kW) | Natural gas G20 Hi = 10,35 kWh/m ³ | | Natural gas G25 Hi = 8,83 kWh/m ³ | | |
|--------------------|---|----------------|--|----------------|-------------|
| | d3/4"-Rp3/4" | d1"1/4-Rp1"1/4 | d3/4"-Rp3/4" | d1"1/4-Rp1"1/4 | d1"1/2-Rp2" |
| 250 | 19 | 6 | 28 | 7 | 4 |
| 300 | 27 | 9 | 40 | 10 | 6 |
| 350 | 37 | 12 | 54 | 13 | 8 |
| 400 | 48 | 15 | 71 | 17 | 10 |
| 460 | 64 | 20 | 94 | 23 | 13 |

Natural gas G20

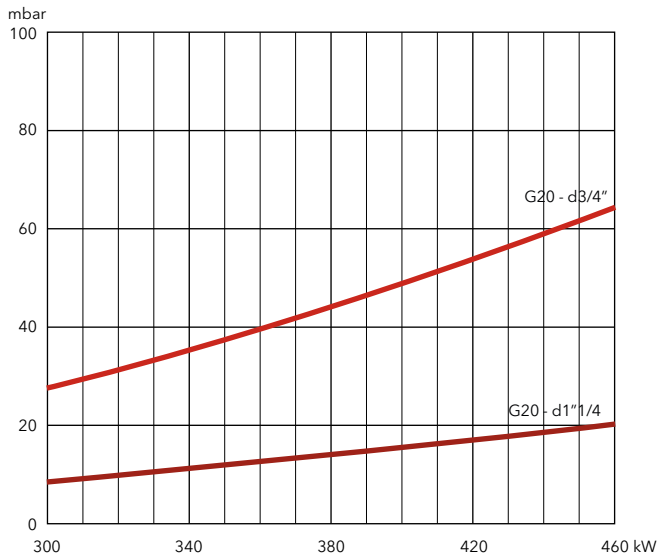

Natural gas G25

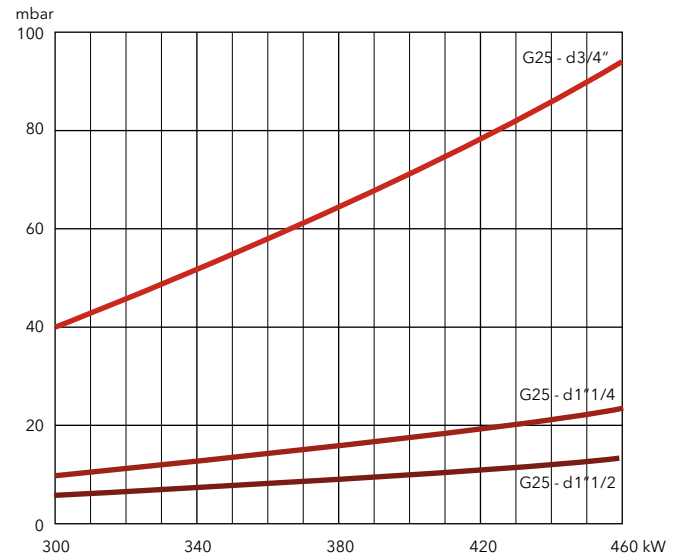



PRESSURE LOSS [BURNER HEAD + GAS TRAIN] (mbar)

VG 4.460 D

| Burner output (kW) | LPG G31 Hi = 25,89 kWh/m ³ | |
|--------------------|---------------------------------------|----------------|
| | d3/4"-Rp3/4" | d1"1/4-Rp1"1/4 |
| 250 | 10 | 6 |
| 300 | 14 | 8 |
| 350 | 19 | 11 |
| 400 | 25 | 15 |
| 460 | 32 | 20 |

LPG

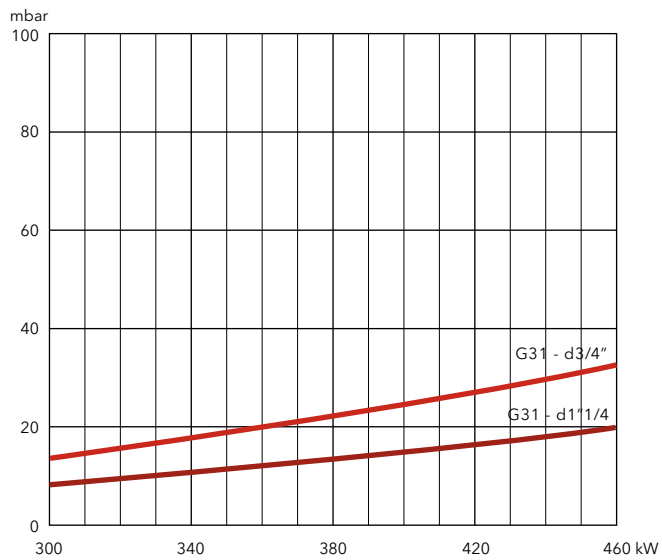

VG2.120 DP E / VG2.160 DP E / VG2.205 DP E

40 ... 205 kW

Two stage progressive/modulating pneumatic

- **Fuels:** natural gas (G20/G25, $H_u = 8,83...10,35 \text{ kWh/m}^3$); LPG (G31, $H_u = 25,89 \text{ kWh/m}^3$)
- **Emissions:** $\text{NO}_x < 56 \text{ mg/kWh}$ (GCV), burners compliant with ErP Directive
- **Operation:** two stage progressive or modulating with the installation of a power regulator and dedicated probes (see page 198)
- **Protection level:** IP 21



TECHNICAL DATA

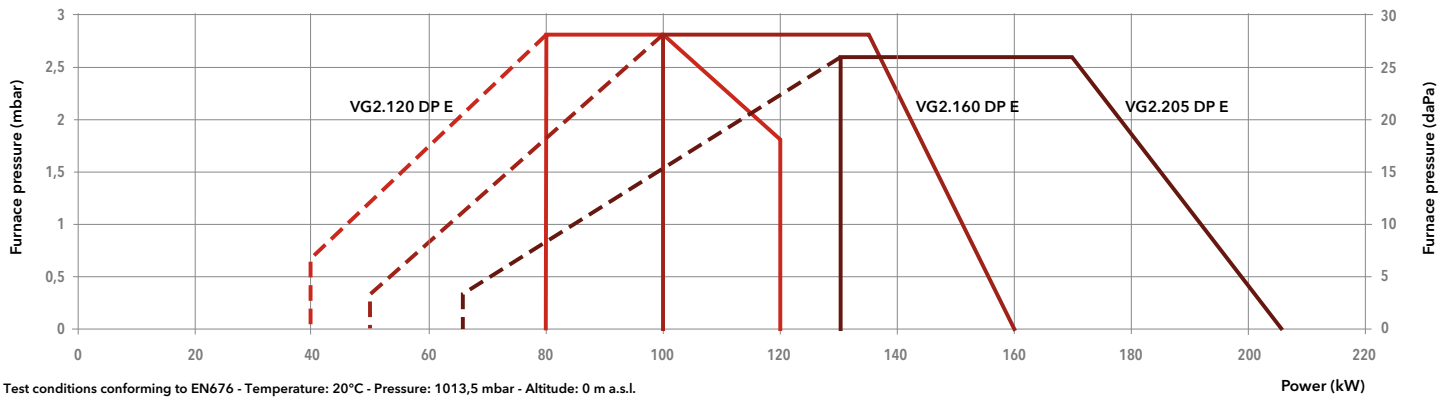

| Model | VG2.120 DP E | | VG2.160 DP E | | VG2.205 DP E | |
|---|---|----------------|---|----------------|---|----------------|
| Operation range | (40) 80 - 120 kW | | (50) 100 - 160 kW | | (65) 130 - 205 kW | |
| Gas pressure | 20 - 100 mbar for d332 gas train; 20 - 300 mbar for d333 gas train | | 20 - 100 mbar for d345 gas train; 20 - 300 mbar for d347 gas train | | 20 - 40 mbar for d348 gas train; 40 - 100 for d346, 100 - 300 for d345 | |
| Control box / flame detection | TCG5... / ionization | | TCG5... / ionization | | TCG5... / ionization | |
| Fan motor | 230 V - 50 Hz - 100 W | | 230 V - 50 Hz - 100 W | | 230 V - 50 Hz - 130 W | |
| Electrical consumption (min/max/stand-by) | 239 W / 358 W / 4 W | | 285 W / 293 W / 4 W | | 302 W / 267 W / 4 W | |
| Acoustic level (LpA) | 62 dB(A) | | 64 dB(A) | | 65 dB(A) | |
| CE certificate | 0476 CT 2423 | | 0476 CT 2423 | | 0476 CT 2423 | |
| Head length | KN | KL | KN | KL | KN | KL |
| Complete burner code | MB-VEF 407 d332-3/4"-Rp3/4" | 3836364 | 3836365 | - | - | - |
| | MB-VEF 407 d333-3/4"-Rp3/4" | 3836366 | 3836367 | - | - | - |
| | MB-VEF 407 d345-3/4"-Rp3/4" | - | - | 3836368 | 3836369 | 3836374 |
| | MB-VEF 407 d346-3/4"-Rp3/4" | - | - | - | - | 3836376 |
| | MB-VEF 407 d347-3/4"-Rp3/4" | - | - | 3836370 | 3836371 | - |
| | MB-VEF 412 d348-1"1/4-Rp1"1/4" | - | - | - | - | 3836372 |

OTHER AVAILABLE VERSIONS

- 60 60 Hz version
- Ver Versions for continuous ventilation and post-ventilation

SCOPE OF SUPPLY

The burner is delivered in its package complete with:

- 1 gas connection flange
- 1 compact gas train with gas filter; the gas filter is built-in for threaded valves (up to 2") and separated for flanged ones (DN65/80/100)
- 1 burner flange with insulation
- 1 bag containing installation fittings
- 1 bag containing technical documentation (instruction manual, technical data, electrical diagram, exploded view and spare parts list)



DIMENSIONS (mm)

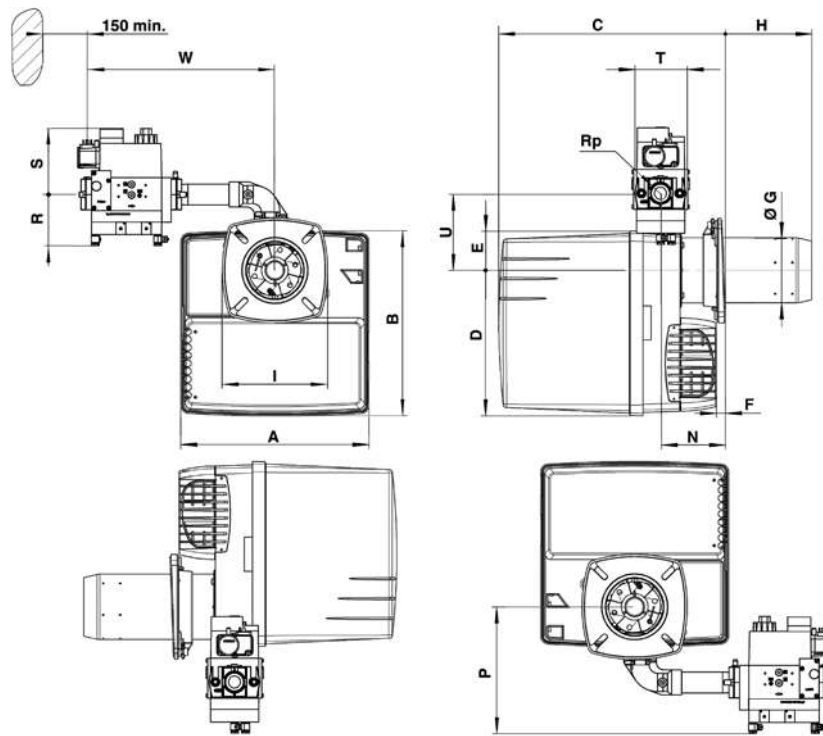

| Model | Gas train model | A | B | C | | D | E | F min | ØG | H | | I | N min | P | Rp | R | S | T | U | W |
|---------|-----------------|-----|-----|-----------|-----------|-----|----|-------|-----|----------|----------|-----|-------|-----|-------|----|-----|-----|-----|-----|
| | | | | KN | KL | | | | | KN | KL | | | | | | | | | |
| VG2.120 | d3/4"-Rp3/4" | 331 | 325 | 398...518 | 398...638 | 256 | 69 | 15 | 115 | 30...150 | 30...270 | 185 | 113 | 179 | 3/4" | 70 | 160 | 120 | 133 | 345 |
| VG2.160 | d3/4"-Rp3/4" | 331 | 325 | 398...518 | 398...638 | 256 | 69 | 15 | 115 | 30...150 | 30...270 | 185 | 113 | 179 | 3/4" | 70 | 160 | 120 | 133 | 345 |
| VG2.205 | d3/4"-Rp3/4" | 331 | 325 | 398...518 | 398...638 | 256 | 69 | 15 | 125 | 30...150 | 30...270 | 185 | 113 | 179 | 3/4" | 70 | 160 | 120 | 133 | 345 |
| | d1"1/4-Rp1"1/4 | 331 | 325 | 398...518 | 398...638 | 256 | 69 | 15 | 125 | 30...150 | 30...270 | 185 | 113 | 188 | 1"1/4 | 80 | 175 | 145 | 133 | 380 |

Connecting flange

| Model | Øa (mm) | b (mm) | c | d |
|-------------|---------|---------|----|-----|
| VG2.120/160 | 120-135 | 150-185 | M8 | 45° |
| VG2.205 | 130-145 | 160-185 | M8 | 45° |

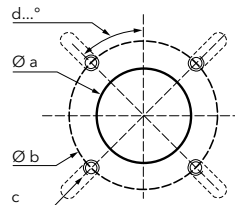

PACKAGING

The burner is delivered in a single package containing all the components

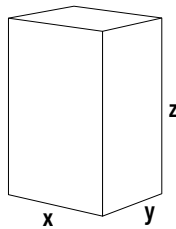

| Burner | Dimensions (mm) | | | Gross weight (kg) |
|---------|-----------------|-----|-----|-------------------|
| | X | Y | Z | |
| VG2.120 | 400 | 400 | 760 | 26 |
| VG2.160 | 400 | 400 | 760 | 26 |
| VG2.205 | 400 | 400 | 760 | 26 |

VG3.290 DP E / VG3.350 DP E

95 ... 350 kW

Two stage progressive/modulating pneumatic

- **Fuels:** natural gas (G20/G25, $H_u = 8,83...10,35 \text{ kWh/m}^3$); LPG (G31, $H_u = 25,89 \text{ kWh/m}^3$)
- **Emissions:** $\text{NO}_x < 56 \text{ mg/kWh}$ (GCV), burners compliant with ErP Directive
- **Operation:** two stage progressive or modulating with the installation of a power regulator and dedicated probes (see page 198)
- **Protection level:** IP 21



TECHNICAL DATA

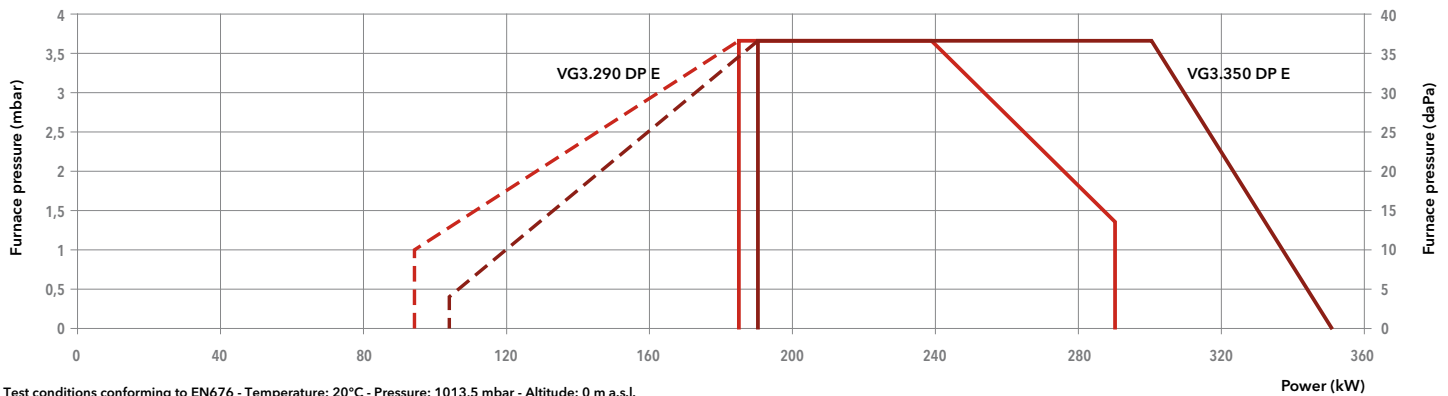

| | VG3.290 DP E | | VG3.350 DP E | |
|--|---------------------------|----------------|-----------------------|----------------|
| Operation range | (95) 185 - 290 kW | | (105) 190 - 350 kW | |
| Gas pressure | 20 - 360 mbar | | 20 - 360 mbar | |
| Control box / flame detection | TCG5... / ionization | | TCG5... / ionization | |
| Fan motor | 230 V - 50 Hz - 250 W | | 230 V - 50 Hz - 300 W | |
| Electrical consumption (max/min/stand-by) | 465 W / 441 W / 4 W | | 583 W / 583 W / 4 W | |
| Acoustic level (LpA) | 67 dB(A) | | 69 dB(A) | |
| CE certificate | 0476 CT 2423 | | 0476 CT 2423 | |
| Head length | KN | KL | KN | KL |
| Complete burner code | MB-VEF 420 d1"1/2-Rp2" | - | 3836414 | 3836415 |
| | MB-VEF 412 d1"1/4-Rp1"1/4 | 3836410 | 3836416 | 3836417 |
| | MB-VEF 407 d3/4"-Rp1" | 3836412 | 3836418 | 3836419 |

OTHER AVAILABLE VERSIONS

- 60 60 Hz version
- TC Version with tightness control
- V_{vent} Versions for continuous ventilation and post-ventilation

SCOPE OF SUPPLY

The burner is delivered in its package complete with:

- 1 burner head with flange seal and securing screws
- 1 compact gas train with gas filter; the gas filter is built-in for threaded valves (up to 2") and separated for flanged ones (DN65/80/100)
- 1 bag containing installation fittings
- 1 bag containing technical documentation (instruction manual, technical data, electrical diagram, exploded view and spare parts list)



DIMENSIONS (mm)

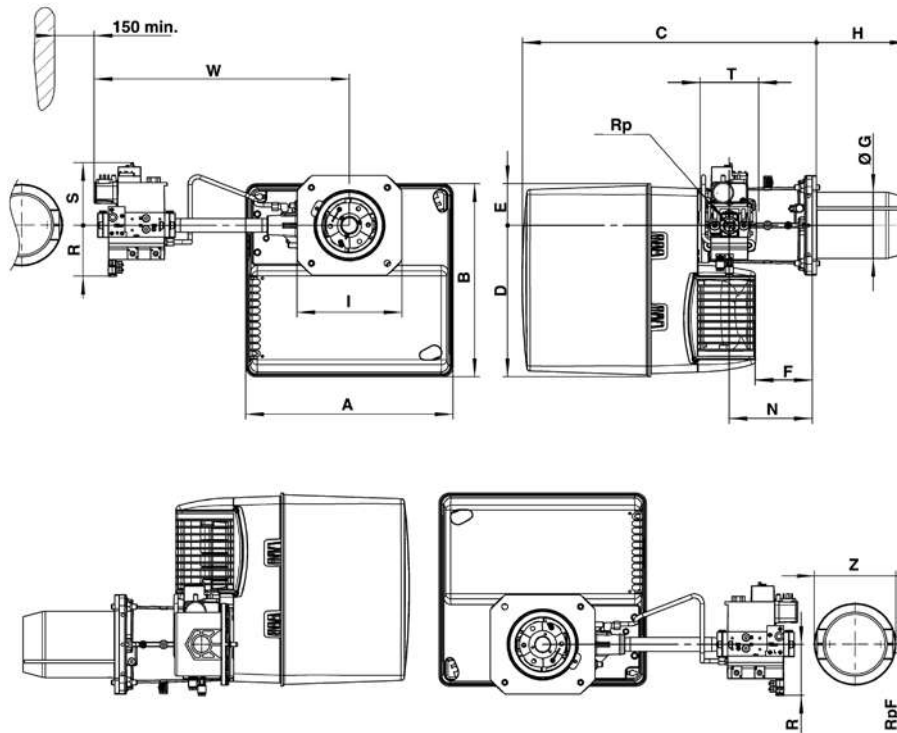

| Gas train model | A | B | C | D | E | F | ØG | H | | I | N | Rp | R | S | T | W | RpF | Z |
|-----------------|-----|-----|-----|-----|----|-----|-----|-----|-----|---------|-----|-------|-----|-----|-----|-----|-----|-----|
| | | | | | | | | KN | KL | | | | | | | | | |
| d1"1/2-Rp2" | 406 | 379 | 576 | 297 | 82 | 120 | 130 | 180 | 320 | 195x205 | 170 | 2" | 100 | 185 | 100 | 603 | - | - |
| d1"1/4-Rp1"1/4 | 406 | 379 | 576 | 297 | 82 | 120 | 130 | 180 | 320 | 195x205 | 170 | 1"1/4 | 80 | 175 | 145 | 526 | - | - |
| d3/4"-Rp1" | 406 | 379 | 576 | 297 | 82 | 120 | 130 | 180 | 320 | 195x205 | 170 | 1" | 70 | 160 | 120 | 479 | 1" | 160 |

Connecting flange

| Øa (mm) | b (mm) | c | d |
|---------|---------|-----|-----|
| 155-190 | 175-220 | M10 | 45° |

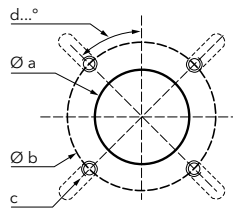

PACKAGING

The burner is delivered on a pallet in three packages containing:

- burner housing
- combustion head
- gas train and filter

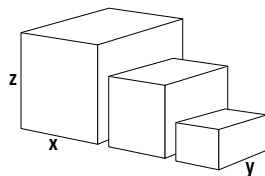

| Component | | Dimensions (mm) | | | Gross weight (kg) |
|-----------------|----------------|-----------------|-----|-----|-------------------|
| | | X | Y | Z | |
| Body | VG3.290 DP E | 440 | 400 | 520 | 21 |
| | VG3.350 DP E | 440 | 400 | 520 | 21 |
| Combustion head | KN | 650 | 210 | 260 | 6 |
| | KL | 780 | 210 | 260 | 7 |
| Gas train | d1"1/2-Rp2" | 670 | 550 | 380 | 12 |
| | d1"1/4-Rp1"1/4 | 600 | 400 | 240 | 11 |
| | d3/4"-Rp1" | 600 | 400 | 240 | 7 |

VG3.290 DP E / VG3.350 DP E

95 ... 350 kW

Two stage progressive/modulating pneumatic

PRESSURE LOSS [BURNER HEAD + GAS TRAIN] (mbar)

VG3.290 DP E

| Burner output (kW) | Natural gas G20 Hi = 10,35 kWh/m ³ | | Natural gas G25 Hi = 8,83 kWh/m ³ | | LPG G31 Hi = 25,89 kWh/m ³ | |
|--------------------|---|----------------|--|----------------|---------------------------------------|----------------|
| | d3/4"-Rp1" | d1"1/4-Rp1"1/4 | d3/4"-Rp1" | d1"1/4-Rp1"1/4 | d3/4"-Rp1" | d1"1/4-Rp1"1/4 |
| 190 | 17 | 9 | 22 | 11 | 11 | 7 |
| 210 | 18 | 9 | 24 | 12 | 12 | 7 |
| 230 | 20 | 9 | 27 | 12 | 12 | 7 |
| 250 | 22 | 10 | 31 | 13 | 13 | 8 |
| 270 | 25 | 11 | 35 | 15 | 14 | 8 |
| 290 | 29 | 13 | 40 | 16 | 16 | 9 |

Natural gas G20

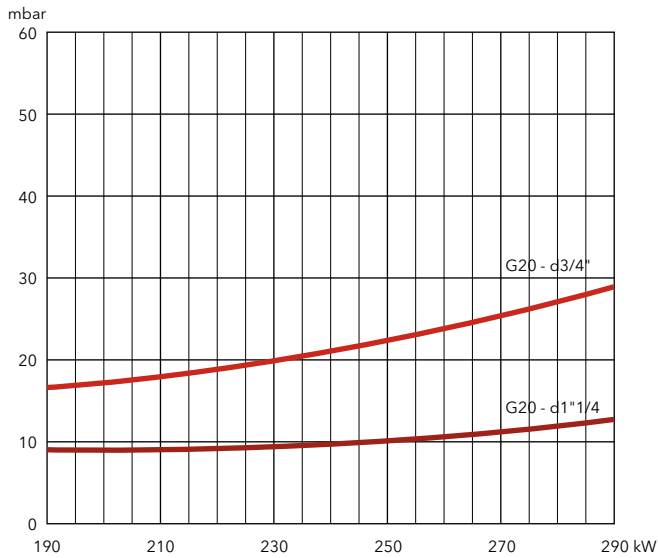

Natural gas G25

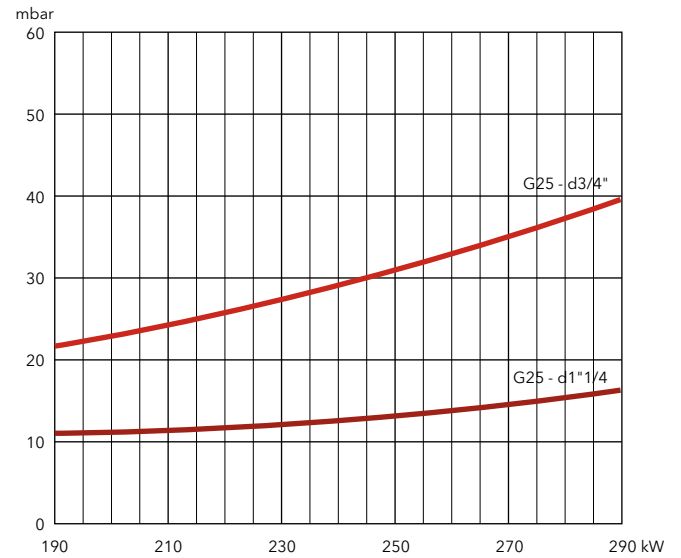

LPG

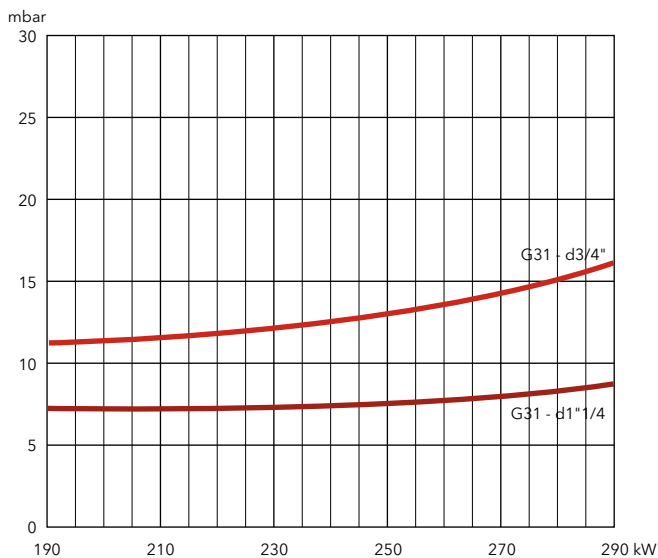



PRESSURE LOSS [BURNER HEAD + GAS TRAIN] (mbar)

VG3.350 DP E

| Burner output (kW) | Natural gas G20 Hi = 10,35 kWh/m ³ | | | Natural gas G25 Hi = 8,83 kWh/m ³ | | | LPG G31 |
|--------------------|---|----------------|-------------|--|----------------|-------------|------------|
| | d3/4"-Rp1" | d1"1/4-Rp1"1/4 | d1"1/2-Rp2" | d3/4"-Rp1" | d1"1/4-Rp1"1/4 | d1"1/2-Rp2" | d3/4"-Rp1" |
| 190 | 13 | 6 | 6 | 19 | 8 | 8 | 8 |
| 230 | 17 | 7 | 7 | 26 | 11 | 10 | 12 |
| 270 | 23 | 9 | 8 | 35 | 15 | 13 | 15 |
| 310 | 29 | 11 | 10 | 44 | 18 | 16 | 18 |
| 350 | 36 | 14 | 12 | 54 | 22 | 19 | 22 |

Natural gas G20

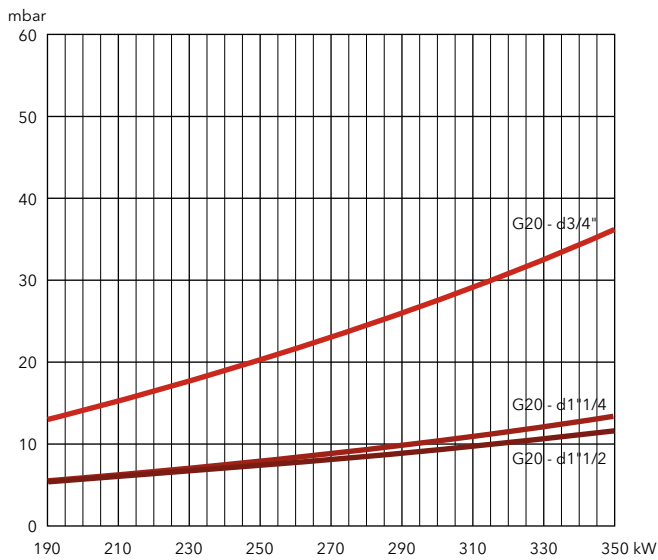

Natural gas G25

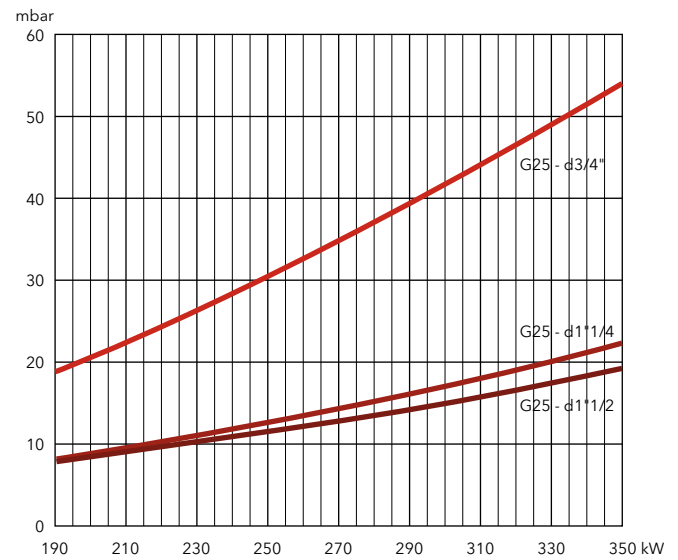

LPG

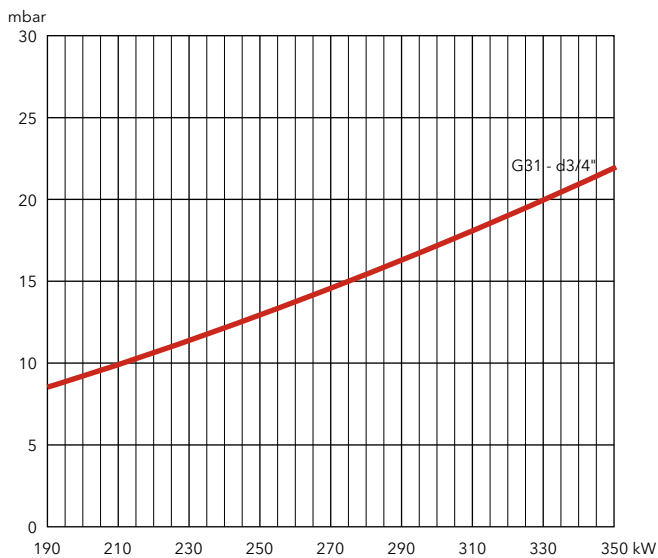

VG4.440 DP E

110 ... 440 kW

Two stage progressive/modulating pneumatic

- **Fuels:** natural gas (G20/G25, $H_u = 8,83...10,35 \text{ kWh/m}^3$); LPG (G31, $H_u = 25,89 \text{ kWh/m}^3$)
- **Emissions:** $\text{NO}_x < 56 \text{ mg/kWh}$ (GCV), burners compliant with ErP Directive
- **Operation:** two stage progressive or modulating with the installation of a power regulator and dedicated probes (see page 198)
- **Protection level:** IP 21



TECHNICAL DATA

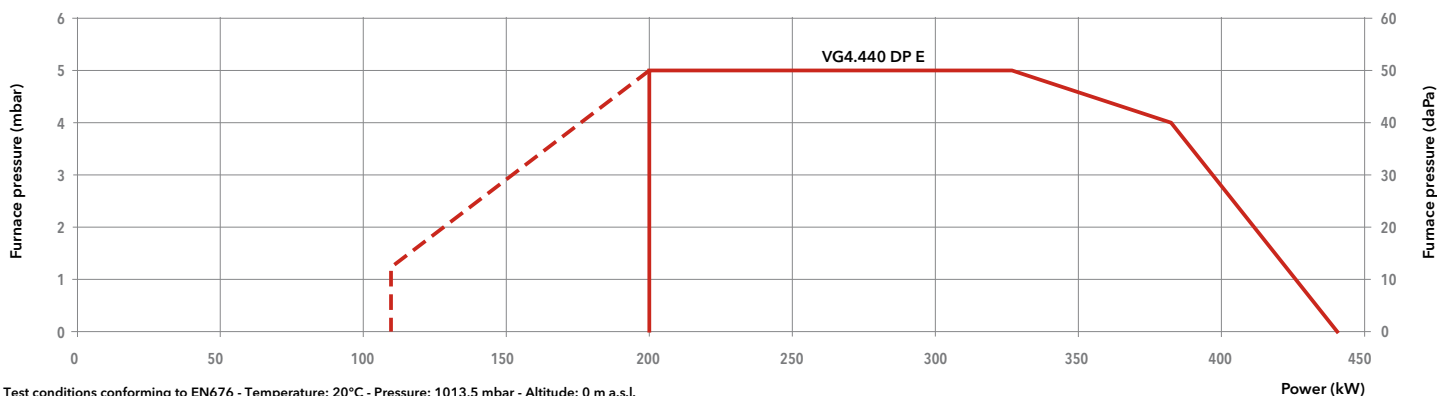

| Model | | VG4.440 DP E | |
|---|---------------------------|-----------------------|---------|
| Operation range | | (110) 200 - 440 kW | |
| Gas pressure | | 20 - 360 mbar | |
| Control box / flame detection | | TCG5.../ionization | |
| Fan motor | | 230 V - 50 Hz - 420 W | |
| Electrical consumption (max/min/stand-by) | | 606 W / 569 W / 4 W | |
| Acoustic level (LpA) | | 70 dB(A) | |
| CE certificate | | 0476 CT 2423 | |
| Head length | | KN | KL |
| Complete burner code | MB-VEF 420 d1"1/2-Rp2" | 3836430 | 3836431 |
| | MB-VEF 412 d1"1/4-Rp1"1/4 | 3836432 | 3836433 |
| | MB-VEF 407 d3/4"-Rp1" | 3836434 | 3836435 |

OTHER AVAILABLE VERSIONS

- 60 60 Hz version
- TC Version with tightness control
- V_{vent} Versions for continuous ventilation and post-ventilation

SCOPE OF SUPPLY

The burner is delivered in its package complete with:

- 1 burner head with flange seal and securing screws
- 1 compact gas train with gas filter; the gas filter is built-in for threaded valves (up to 2") and separated for flanged ones (DN65/80/100)
- 1 bag containing installation fittings
- 1 bag containing technical documentation (instruction manual, technical data, electrical diagram, exploded view and spare parts list)



DIMENSIONS (mm)

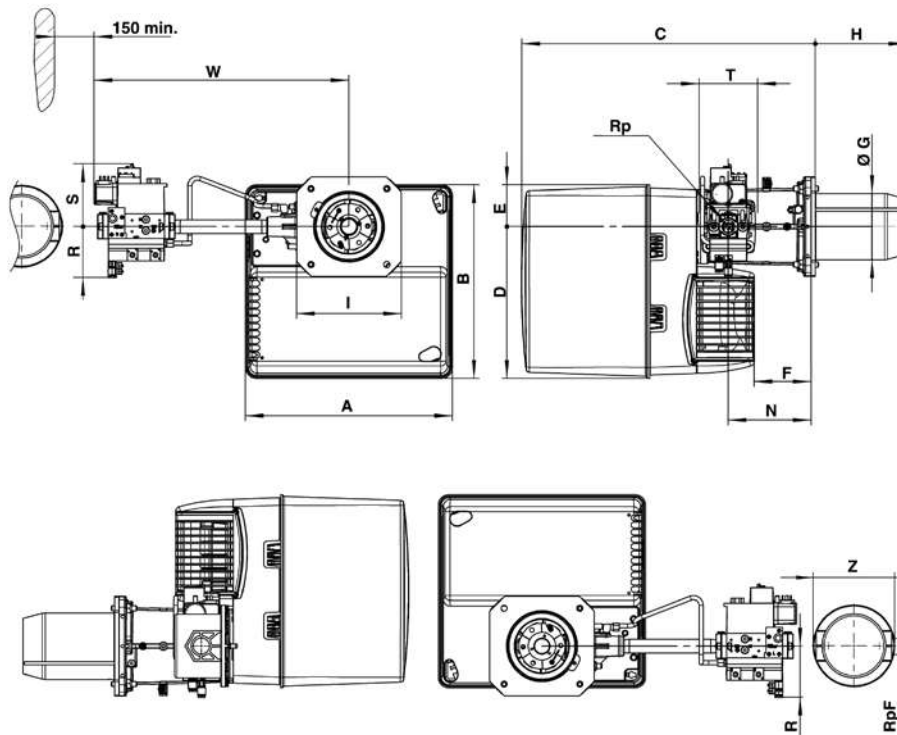

| Gas train model | A | B | C | D | E | F | ØG | H | | I | N | Rp | R | S | T | W | RpF | Z |
|-----------------|-----|-----|-----|-----|----|-----|-----|-----|-----|-----|-----|-------|-----|-----|-----|-----|-----|-----|
| | | | | | | | | KN | KL | | | | | | | | | |
| d1"1/2-Rp2" | 465 | 475 | 640 | 377 | 97 | 149 | 157 | 212 | 352 | 245 | 195 | 2" | 100 | 185 | 100 | 613 | - | - |
| d1"1/4-Rp1"1/4 | 465 | 475 | 640 | 377 | 97 | 149 | 157 | 212 | 352 | 245 | 195 | 1"1/4 | 80 | 175 | 145 | 536 | - | - |
| d3/4"-Rp1" | 465 | 475 | 640 | 377 | 97 | 149 | 157 | 212 | 352 | 245 | 195 | 1" | 70 | 160 | 120 | 489 | 1" | 160 |

Connecting flange

| Øa (mm) | b (mm) | c | d |
|---------|---------|-----|-----|
| 190-240 | 200-270 | M10 | 45° |

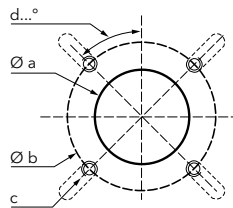

PACKAGING

The burner is delivered on a pallet in three packages containing:

- burner housing
- combustion head
- gas train and filter

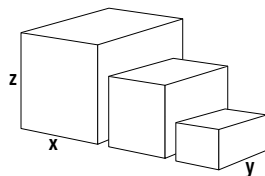

| Component | | Dimensions (mm) | | | Gross weight (kg) |
|-----------------|----------------|-----------------|-----|-----|-------------------|
| | | X | Y | Z | |
| Burner body | VG4.440 DP E | 490 | 490 | 590 | 28,6 |
| | KN | 750 | 260 | 295 | 8,9 |
| Combustion head | KL | 895 | 260 | 295 | 10,1 |
| | d1"1/2-Rp2" | 670 | 550 | 380 | 12 |
| Gas train | d1"1/4-Rp1"1/4 | 600 | 400 | 240 | 11 |
| | d3/4"-Rp1" | 600 | 400 | 240 | 7 |

VG4.440 DP E

110 ... 440 kW

Two stage progressive/modulating pneumatic

PRESSURE LOSS [BURNER HEAD + GAS TRAIN] (mbar)

VG4.440 DP E

| Burner output (kW) | Natural gas G20 Hi = 10,35 kWh/m ³ | | | Natural gas G25 Hi = 8,83 kWh/m ³ | | |
|--------------------|---|----------------|-------------|--|----------------|-------------|
| | d3/4"-Rp1" | d1"1/4-Rp1"1/4 | d1"1/2-Rp2" | d3/4"-Rp1" | d1"1/4-Rp1"1/4 | d1"1/2-Rp2" |
| 240 | 19 | 8 | 7 | 27 | 11 | 10 |
| 280 | 24 | 9 | 8 | 35 | 13 | 11 |
| 320 | 30 | 11 | 9 | 42 | 15 | 12 |
| 360 | 37 | 13 | 11 | 51 | 18 | 15 |
| 400 | 44 | 15 | 13 | 64 | 22 | 17 |
| 440 | 51 | 18 | 15 | 78 | 25 | 20 |

Natural gas G20

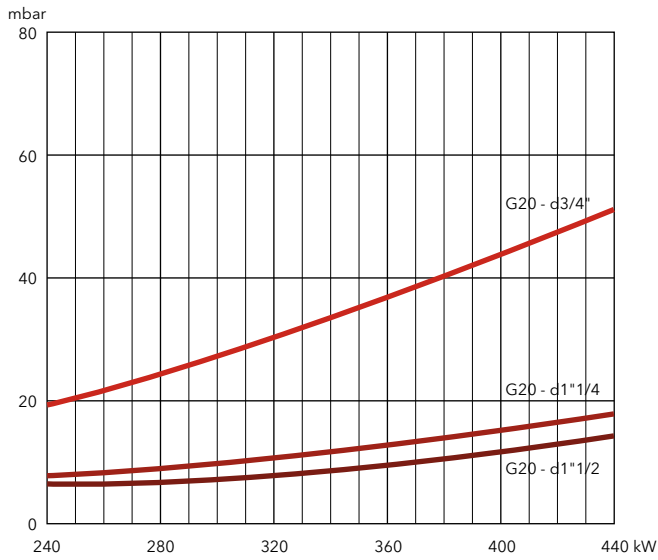

Natural gas G25

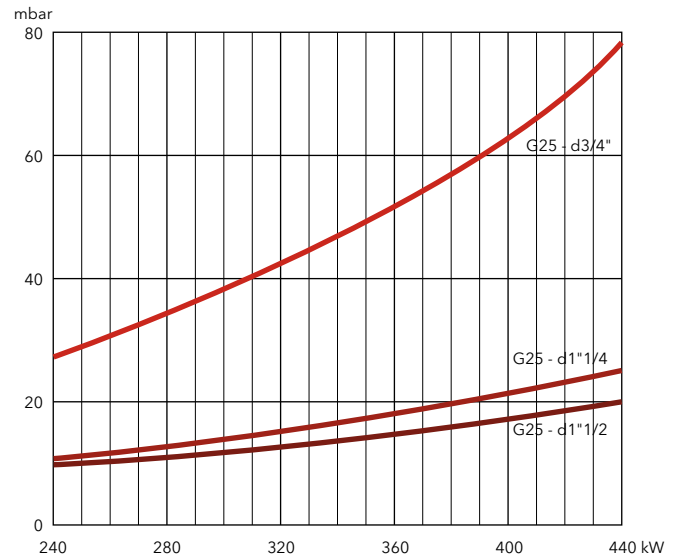



PRESSURE LOSS [BURNER HEAD + GAS TRAIN] (mbar)

VG4.440 DP E

| Burner output (kW) | LPG G31 Hi = 25,89 kWh/m ³ | |
|--------------------|---------------------------------------|----------------|
| | d3/4"-Rp1" | d1"1/4-Rp1"1/4 |
| 240 | 13 | 8 |
| 280 | 16 | 9 |
| 320 | 18 | 10 |
| 360 | 22 | 11 |
| 400 | 26 | 13 |
| 440 | 32 | 16 |

LPG

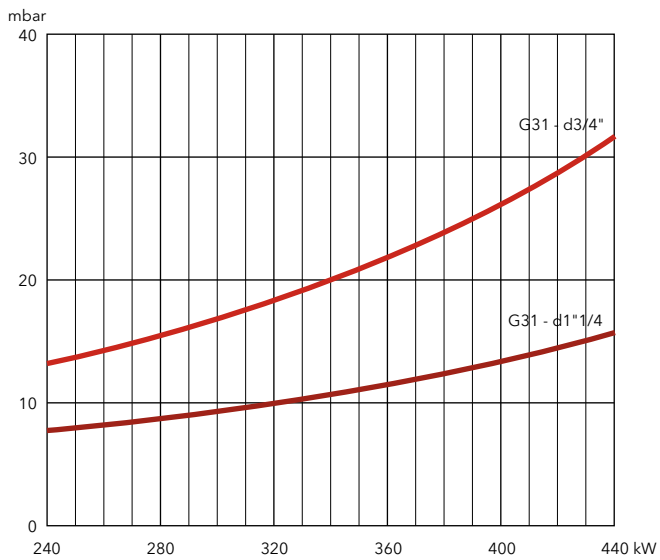

VG4.460 DP / VG4.610 DP

100 ... 610 kW

Two stage progressive/modulating pneumatic

- **Fuels:** natural gas, net calorific value 8,83...10,35 kWh/m³;
LPG, net calorific value 25,89 kWh/m³
- **Emissions:** NOx < 70 mg/kWh (NCV), Low NOx class 3 burners according to EN676
- **Operation:** two stage progressive or modulating with the installation of a power regulator and dedicated probes (see page 198)
- **Protection level:** IP 41



TECHNICAL DATA

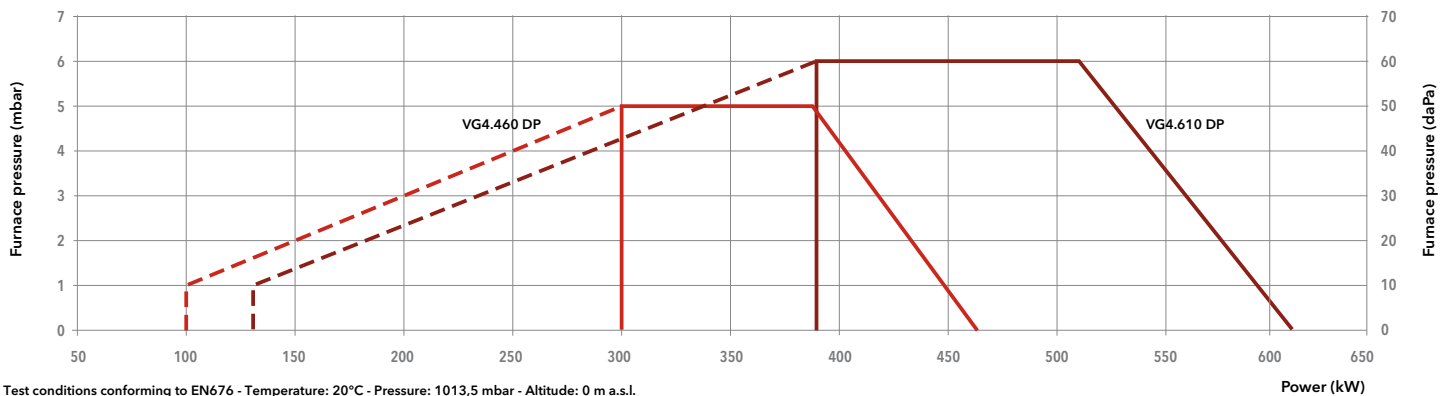

| Model | VG 4.460 DP | | VG 4.610 DP | |
|-------------------------------|---------------------------|---------|-----------------------|---------|
| Operation range | (100) 300 - 460 kW | | (130) 390 - 610 kW | |
| Gas pressure | 20 - 300 mbar | | 20 - 300 mbar | |
| Control box / flame detection | TCG5... / ionization | | TCG5... / ionization | |
| Fan motor | 230 V - 50 Hz - 420 W | | 230 V - 50 Hz - 750 W | |
| Electrical consumption | 68 + 522 W | | 68 + 720 W | |
| Acoustic level (LpA) | 70 dB(A) | | 71 dB(A) | |
| CE certificate | 1312 CL 5412 | | 1312 CL 5412 | |
| Head length | KN | KL | KN | KL |
| Complete burner code | MB-VEF 420 d1"1/2-Rp2" | 3833423 | 3833415 | 3833416 |
| | MB-VEF 412 d1"1/4-Rp1"1/4 | 3833411 | 3833417 | 3833418 |
| | MB-VEF 407 d3/4"-Rp1" | 3833413 | 3833419 | 3833420 |

OTHER AVAILABLE VERSIONS

- 60 60 Hz version
- TC Version with tightness control
- V_{vent} Versions for continuous ventilation and post-ventilation

SCOPE OF SUPPLY

The burner is delivered in its package complete with:

- 1 burner head with flange seal and securing screws
- 1 compact gas train with gas filter
- 1 bag containing installation fittings
- 1 bag containing technical documentation (instruction manual, technical data, electrical diagram, exploded view and spare parts list)

DIMENSIONS (mm)

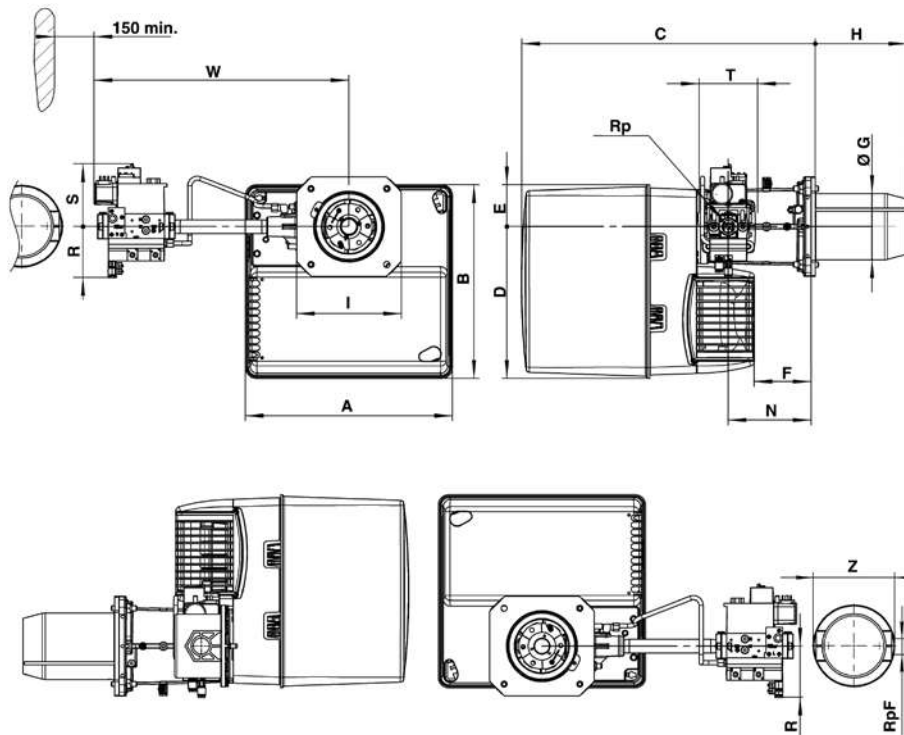

| Gas train model | A | B | C | D | E | F | ØG | H | | I | N | Rp | R | S | T | W | RpF | Z |
|-----------------|-----|-----|-----|-----|----|-----|-----|-----|-----|-----|-----|-------|-----|-----|-----|-----|-----|-----|
| | | | | | | | | KN | KL | | | | | | | | | |
| d1"1/2-Rp2" | 465 | 475 | 640 | 377 | 97 | 149 | 150 | 220 | 360 | 245 | 195 | 2" | 100 | 185 | 100 | 613 | - | - |
| d1"1/4-Rp1"1/4 | 465 | 475 | 640 | 377 | 97 | 149 | 150 | 220 | 360 | 245 | 195 | 1"1/4 | 80 | 175 | 145 | 536 | - | - |
| d3/4"-Rp1" | 465 | 475 | 640 | 377 | 97 | 149 | 150 | 220 | 360 | 245 | 195 | 1" | 70 | 160 | 120 | 489 | 1" | 160 |

Connecting flange

| Øa (mm) | b (mm) | c | d |
|---------|---------|-----|-----|
| 180-240 | 200-270 | M10 | 45° |

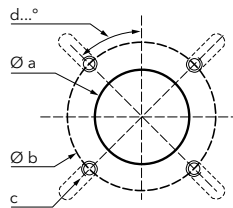

PACKAGING

The burner is delivered on a pallet in three packages containing:

- burner housing
- combustion head
- gas train and filter

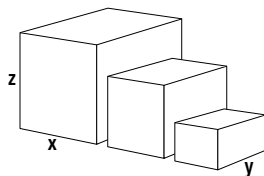

| Component | | Dimensions (mm) | | | Gross weight (kg) |
|-----------------|----------------|-----------------|-----|-----|-------------------|
| | | X | Y | Z | |
| Burner body | VG 4.460 DP | 490 | 490 | 590 | 28,6 |
| | VG 4.610 DP | 490 | 490 | 590 | 32,7 |
| Combustion head | KN | 750 | 260 | 295 | 8,9 |
| | KL | 895 | 260 | 295 | 10,1 |
| Gas train | d1"1/2-Rp2" | 670 | 550 | 380 | 12 |
| | d1"1/4-Rp1"1/4 | 600 | 400 | 240 | 11 |
| | d3/4"-Rp1" | 600 | 400 | 240 | 7 |

VG4.460 DP / VG4.610 DP

100 ... 610 kW

Two stage progressive/modulating pneumatic

PRESSURE LOSS [BURNER HEAD + GAS TRAIN] (mbar)

VG 4.460 DP

| Burner output (kW) | Natural gas G20 Hi = 10,35 kWh/m ³ | | Natural gas G25 Hi = 8,83 kWh/m ³ | | | LPG G31 Hi = 25,89 kWh/m ³ | |
|--------------------|---|----------------|--|----------------|-------------|---------------------------------------|----------------|
| | d3/4"-Rp1" | d1"1/4-Rp1"1/4 | d3/4"-Rp1" | d1"1/4-Rp1"1/4 | d1"1/2-Rp2" | d3/4"-Rp1" | d1"1/4-Rp1"1/4 |
| 300 | 40 | 8 | 59 | 11 | 6 | 18 | 8 |
| 350 | 54 | 10 | 81 | 15 | 9 | 24 | 11 |
| 400 | 70 | 14 | 106 | 19 | 12 | 31 | 14 |
| 450 | 89 | 17 | 134 | 24 | 15 | 40 | 18 |
| 510 | 114 | 22 | 172 | 31 | 19 | 51 | 23 |

Natural gas G20

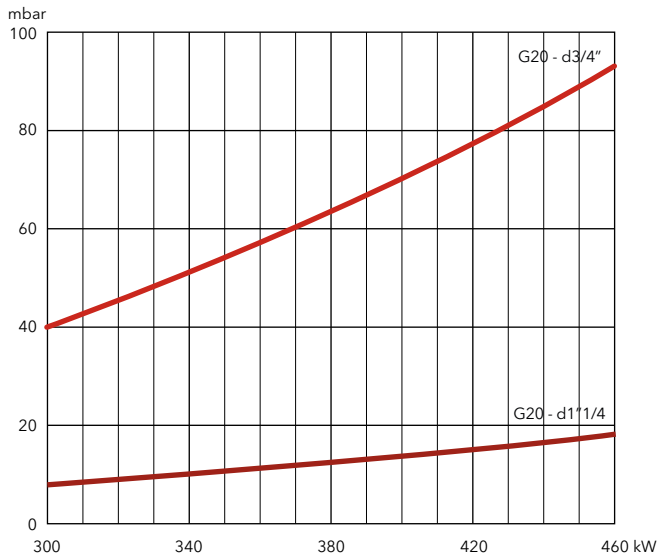

Natural gas G25

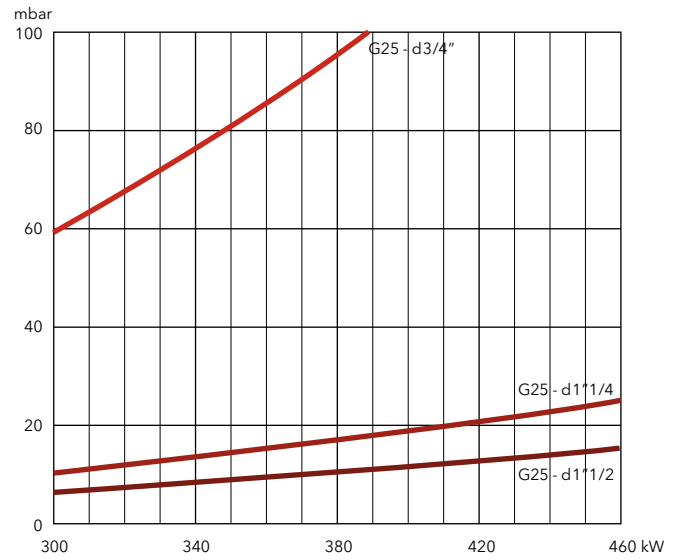

LPG

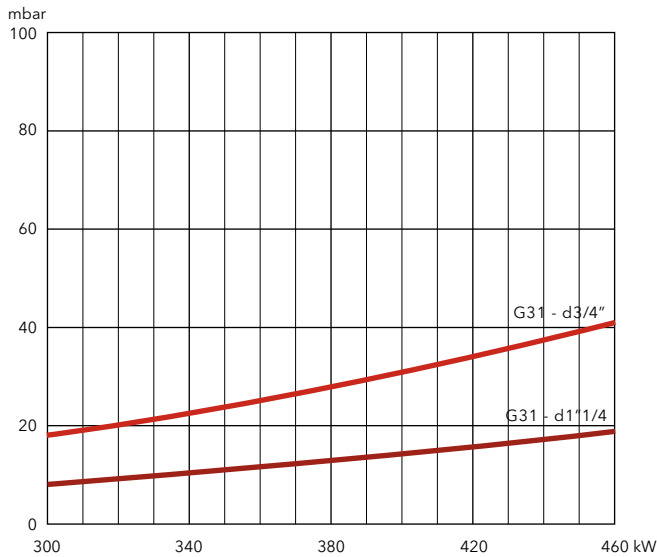



PRESSURE LOSS [BURNER HEAD + GAS TRAIN] (mbar)

VG 4.610 DP

| Burner output (kW) | Natural gas G20 Hi = 10,35 kWh/m ³ | | | Natural gas G25 Hi = 8,83 kWh/m ³ | | | LPG G31 Hi = 25,89 kWh/m ³ | |
|--------------------|---|----------------|-------------|--|----------------|-------------|---------------------------------------|----------------|
| | d3/4"-Rp1" | d1"1/4-Rp1"1/4 | d1"1/2-Rp2" | d3/4"-Rp1" | d1"1/4-Rp1"1/4 | d1"1/2-Rp2" | d3/4"-Rp1" | d1"1/4-Rp1"1/4 |
| 350 | 53 | 9 | 6 | 78 | 13 | 7 | 25 | 8 |
| 400 | 70 | 12 | 8 | 102 | 17 | 9 | 32 | 10 |
| 450 | 88 | 16 | 10 | 129 | 21 | 11 | 41 | 13 |
| 500 | 109 | 19 | 12 | 159 | 26 | 14 | 50 | 16 |
| 550 | 132 | 23 | 15 | 192 | 32 | 17 | 61 | 20 |
| 610 | 162 | 29 | 18 | 236 | 39 | 20 | 75 | 24 |

Natural gas G20

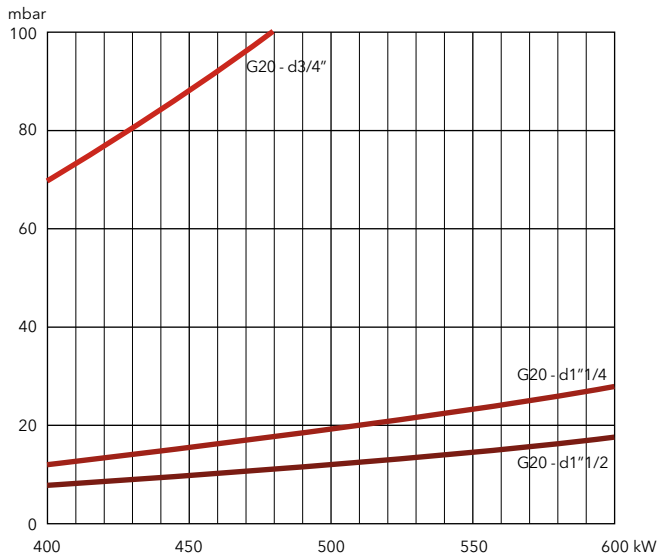

Natural gas G25

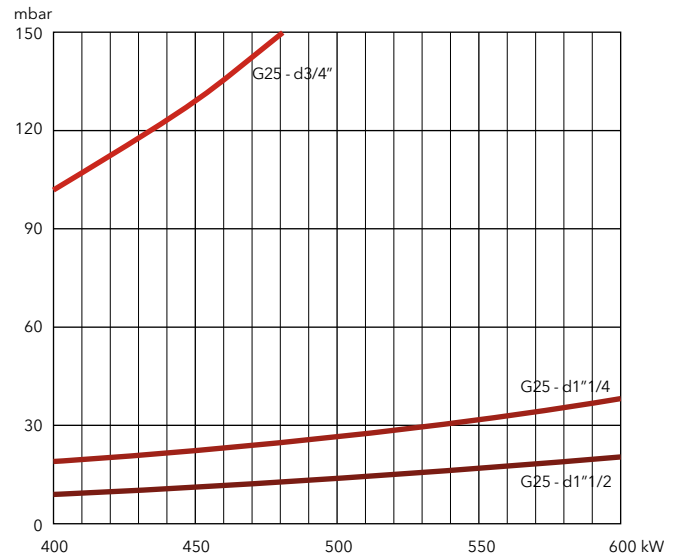

LPG

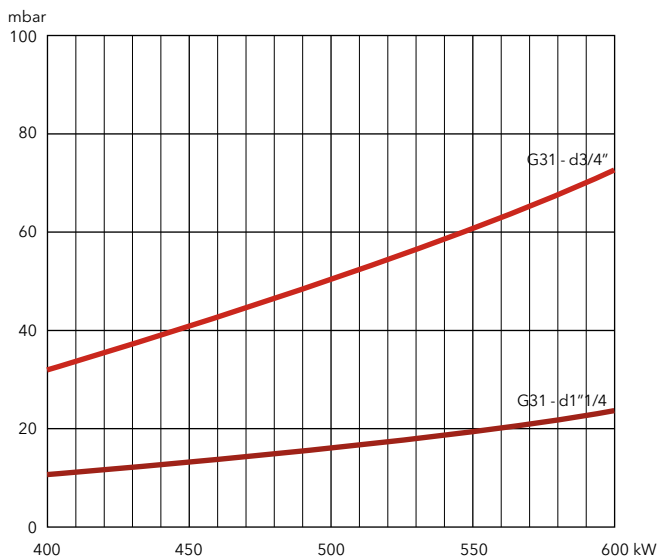

VG5.950 DP / VG5.1200 DP

170 ... 1160 kW

Two stage progressive/modulating pneumatic

- **Fuels:** natural gas (G20/G25, $H_u = 8,83...10,35 \text{ kWh/m}^3$); LPG (G31, $H_u = 25,89 \text{ kWh/m}^3$)
- **Emissions:** $\text{NO}_x < 70 \text{ mg/kWh}$ (NCV), Low NO_x class 3 burners according to EN676
- **Operation:** two stage progressive or modulating with the installation of a power regulator and dedicated probes (see page 198)
- **Protection level:** IP 21



TECHNICAL DATA

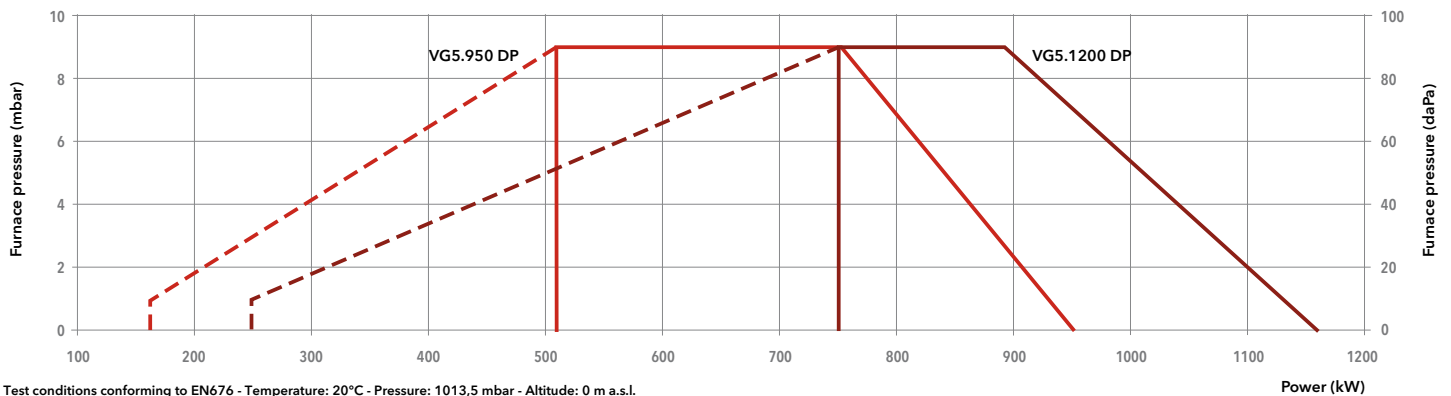

Test conditions conforming to EN676 - Temperature: 20°C - Pressure: 1013,5 mbar - Altitude: 0 m a.s.l.

| Model | VG5.950 DP | | | VG5.1200 DP | | |
|-------------------------------|----------------------------|---------|---------|----------------------------|---------|---------|
| Operation range | (170)510 – 950 kW | | | (250)750 – 1160 kW | | |
| Gas pressure | 20 – 300 mbar | | | 20 – 300 mbar | | |
| Control box / flame detection | TCG 5.. / ionization | | | TCG 5.. / ionization | | |
| Fan motor | 230/400 V – 50 Hz – 1,5 kW | | | 230/400 V – 50 Hz – 1,5 kW | | |
| Electrical consumption | 65 + 1884 W | | | 67 + 2052 W | | |
| Acoustic level (LpA) | 77 dB(A) | | | 77 dB(A) | | |
| CE certificate | 1312 CN 5684 | | | 1312 CN 5684 | | |
| Head length | KN | KL | KM | KN | KL | KM |
| Complete burner code | VGD 40-065 s65-DN65 | - | - | 3833603 | 3833604 | 3833629 |
| | VGD 20-5011 s2"-Rp2" | 3833595 | 3833596 | 3833597 | 3833598 | 3833631 |
| | MB-VEF 420 d1 1/2-Rp2" | 3833585 | 3833586 | 3833623 | 3833589 | 3833633 |
| | MB-VEF 412 d1 1/4-Rp2" | 3833579 | 3833580 | 3833625 | 3833581 | 3833635 |
| | MB-VEF 407 d3/4"-Rp1" | 3833583 | 3833584 | 3833627 | - | - |

OTHER AVAILABLE VERSIONS

- 60 60 Hz version
- TC Version with tightness control
- V_{vent} Versions for continuous ventilation and post-ventilation

SCOPE OF SUPPLY

The burner is delivered in its package complete with:

- 1 burner head with flange seal and securing screws
- 1 compact gas train with gas filter; the gas filter is built-in for threaded valves (up to 2") and separated for flanged ones (DN65/80/100)
- 1 bag containing installation fittings
- 1 bag containing technical documentation (instruction manual, technical data, electrical diagram, exploded view and spare parts list)



DIMENSIONS (mm)

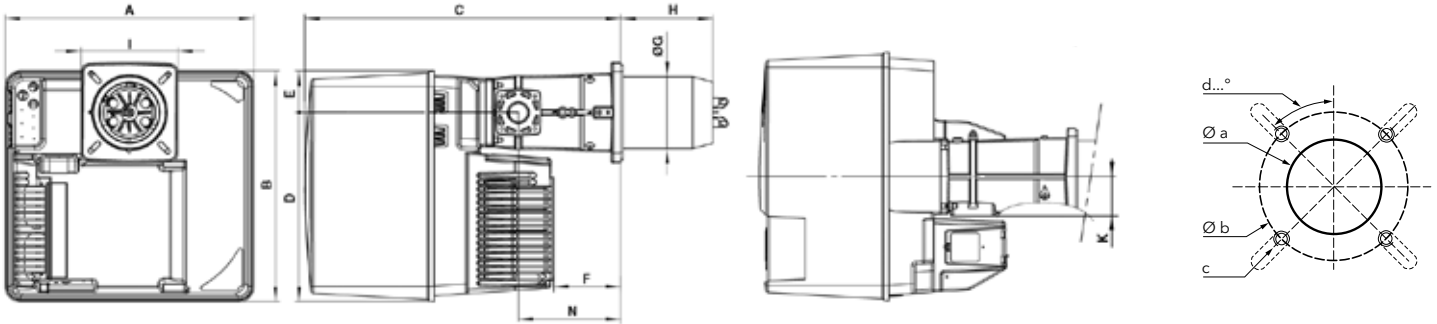

| A | B | C | D | E | F | ØG | H | | | I | K | N |
|-----|-----|-----|-----|----|-----|-----|-----|-----|-----|---------|----|-----|
| | | | | | | | KN | KM | KL | | | |
| 581 | 549 | 752 | 450 | 99 | 164 | 170 | 215 | 325 | 435 | 230x238 | 89 | 244 |

| Øa (mm) | b (mm) | c | d |
|---------|---------|-----|-----|
| 195 | 220-260 | M10 | 45° |

Gas trains

Gas train "d":

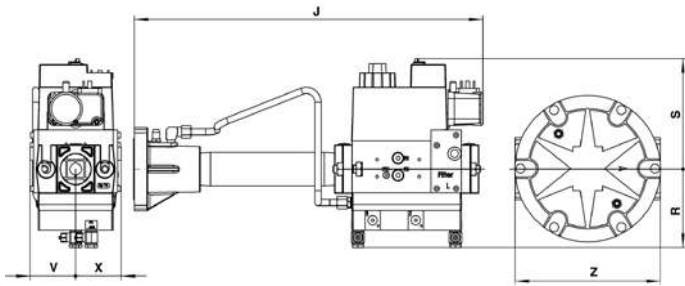

| Model | J | R | S | V | X | Z |
|-------------|-----|-----|-----|----|----|-----|
| d1"1/2-Rp2" | 540 | 123 | 190 | 55 | 55 | - |
| d1"1/4-Rp2" | 450 | 100 | 141 | 58 | 58 | 186 |
| d3/4"-Rp1" | 420 | 100 | 122 | 55 | 50 | 160 |

Gas train "s":

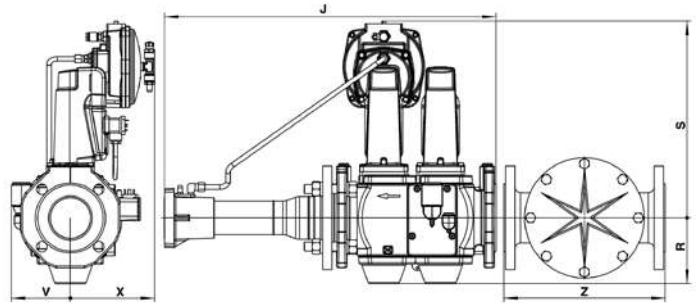

| Model | J | R | S | V | X | Z |
|----------|-----|-----|-----|-----|-----|-----|
| s65-DN65 | 600 | 135 | 360 | 110 | 150 | 290 |
| s2"-Rp2" | 612 | 103 | 330 | 110 | 150 | 186 |

PACKAGING

The burner is delivered on a pallet in three packages containing:

- burner housing
- combustion head
- gas train and filter

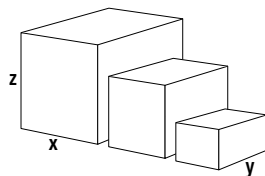

| Component | | Dimensions (mm) | | | Gross weight (kg) |
|-----------------|-------------|-----------------|-----|-----|-------------------|
| | | X | Y | Z | |
| Burner body | VG5.950 DP | 800 | 600 | 850 | 53 |
| | VG5.1200 DP | 800 | 600 | 850 | 54 |
| Combustion head | KN | 780 | 265 | 280 | 12,3 |
| | KL | 1010 | 265 | 280 | 14,4 |
| | KM | 1010 | 265 | 280 | 13,4 |
| Gas train | s65-DN65 | 790 | 600 | 500 | 29 |
| | s2"-Rp2" | 790 | 600 | 500 | 17,2 |
| | d1"1/2-Rp2" | 670 | 550 | 380 | 12 |
| | d1"1/4-Rp2" | 600 | 400 | 240 | 12 |
| | d3/4"-Rp1" | 600 | 400 | 240 | 7 |

VG5.950 DP / VG5.1200 DP

170 ... 1160 kW

Two stage progressive/modulating pneumatic

PRESSURE LOSS [BURNER HEAD + GAS TRAIN] (mbar)

VG5.950 DP

| Burner output (kW) | Natural gas G20 Hi = 10,35 kWh/m ³ | | | | Natural gas G25 Hi = 8,83 kWh/m ³ | | | | LPG G31 Hi = 25,89 kWh/m ³ | | | |
|--------------------|---|-------------|-------------|----------|--|-------------|-------------|----------|---------------------------------------|-------------|-------------|----------|
| | d3/4"-Rp1" | d1"1/4-Rp2" | d1"1/2-Rp2" | s2"-Rp2" | d3/4"-Rp1" | d1"1/4-Rp2" | d1"1/2-Rp2" | s2"-Rp2" | d3/4"-Rp1" | d1"1/4-Rp2" | d1"1/2-Rp2" | s2"-Rp2" |
| 550 | 104 | 32 | 10 | 7 | 157 | 46 | 13 | 10 | 47 | 16 | 9 | 9 |
| 600 | 122 | 38 | 11 | 9 | 186 | 54 | 16 | 12 | 56 | 19 | 11 | 11 |
| 650 | 145 | 45 | 13 | 11 | 219 | 64 | 19 | 14 | 66 | 22 | 13 | 13 |
| 700 | 168 | 52 | 15 | 12 | 253 | 74 | 22 | 16 | 76 | 25 | 14 | 14 |
| 750 | 193 | 60 | 18 | 14 | 292 | 85 | 25 | 18 | 88 | 28 | 16 | 16 |
| 800 | 219 | 68 | 21 | 16 | - | 96 | 29 | 21 | 99 | 32 | 19 | 19 |
| 850 | 248 | 77 | 24 | 18 | - | 109 | 33 | 24 | 112 | 37 | 21 | 21 |
| 900 | 277 | 86 | 27 | 20 | - | 122 | 36 | 27 | 126 | 41 | 24 | 24 |
| 950 | 308 | 95 | 29 | 23 | - | 136 | 40 | 30 | 141 | 46 | 27 | 27 |

Natural gas G20

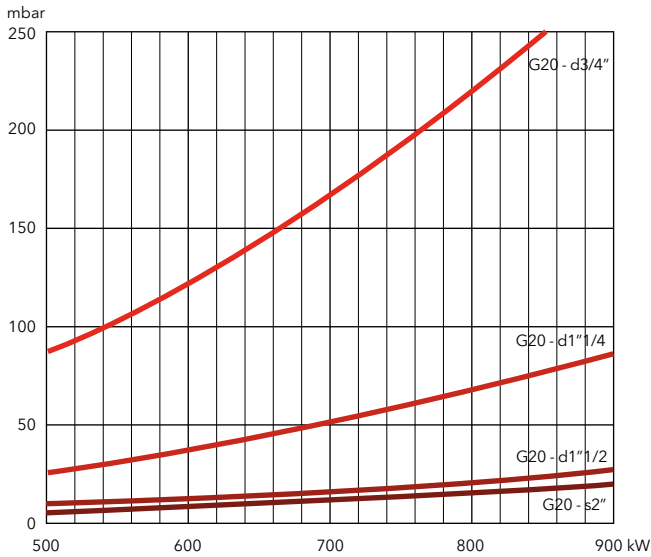

Natural gas G25

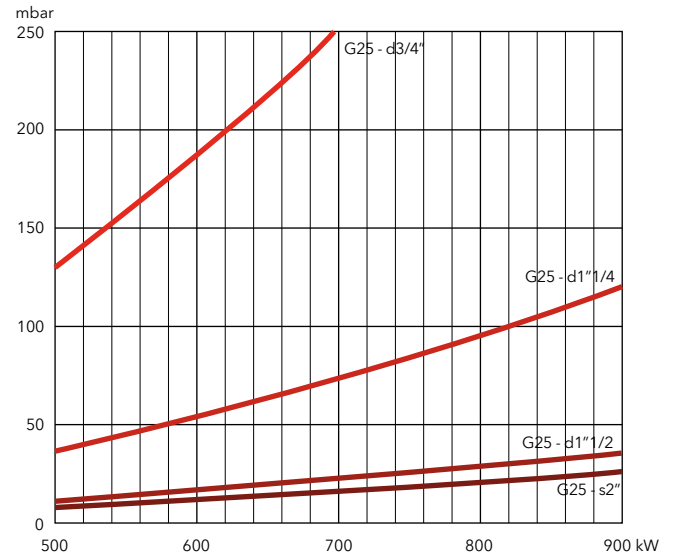

LPG

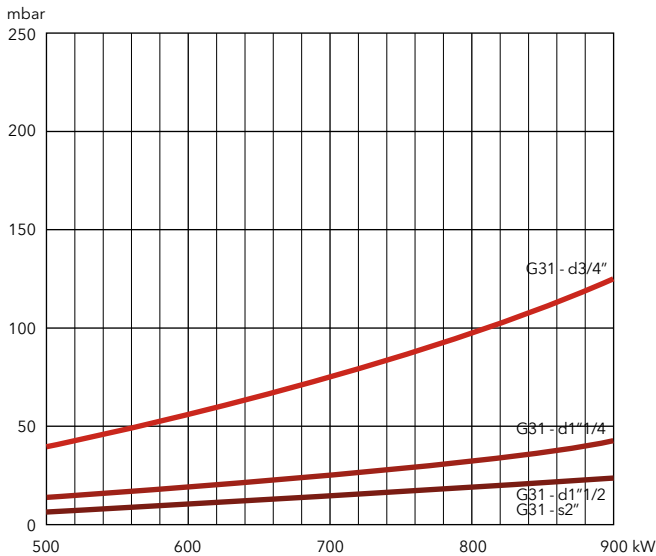



PRESSURE LOSS [BURNER HEAD + GAS TRAIN] (mbar)

VG5.1200 DP

| Burner output (kW) | Natural gas G20 Hi = 10,35 kWh/m ³ | | | | Natural gas G25 Hi = 8,83 kWh/m ³ | | | | LPG G31 Hi = 25,89 kWh/m ³ | | |
|--------------------|---|-------------|----------|----------|--|-------------|----------|----------|---------------------------------------|-------------|----------|
| | d1"1/4-Rp2" | d1"1/2-Rp2" | s2"-Rp2" | s65-Rp2" | d1"1/4-Rp2" | d1"1/2-Rp2" | s2"-Rp2" | s65-Rp2" | d1"1/4-Rp2" | d1"1/2-Rp2" | s2"-Rp2" |
| 750 | 56 | 18 | 14 | 12 | 82 | 24 | 19 | 14 | 28 | 14 | 14 |
| 800 | 65 | 21 | 16 | 13 | 92 | 27 | 22 | 16 | 32 | 16 | 16 |
| 850 | 74 | 24 | 18 | 15 | 105 | 30 | 25 | 18 | 36 | 18 | 18 |
| 900 | 83 | 27 | 20 | 17 | 118 | 33 | 28 | 20 | 41 | 20 | 20 |
| 950 | 94 | 30 | 22 | 19 | 131 | 37 | 31 | 23 | 46 | 22 | 22 |
| 1000 | 103 | 33 | 25 | 21 | 145 | 42 | 34 | 26 | 51 | 24 | 25 |
| 1050 | 113 | 37 | 27 | 23 | 160 | 47 | 38 | 28 | 56 | 27 | 27 |
| 1100 | 124 | 40 | 30 | 25 | 175 | 51 | 42 | 31 | 61 | 30 | 30 |
| 1150 | 136 | 44 | 33 | 27 | 192 | 55 | 46 | 34 | 67 | 33 | 33 |

Natural gas G20

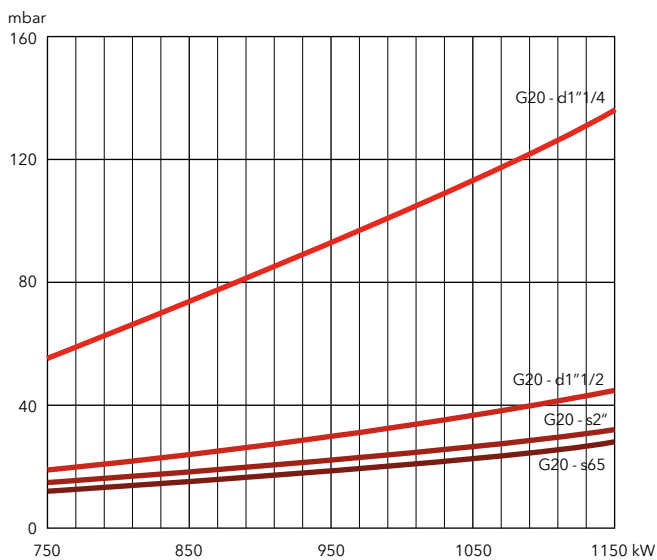

Natural gas G25

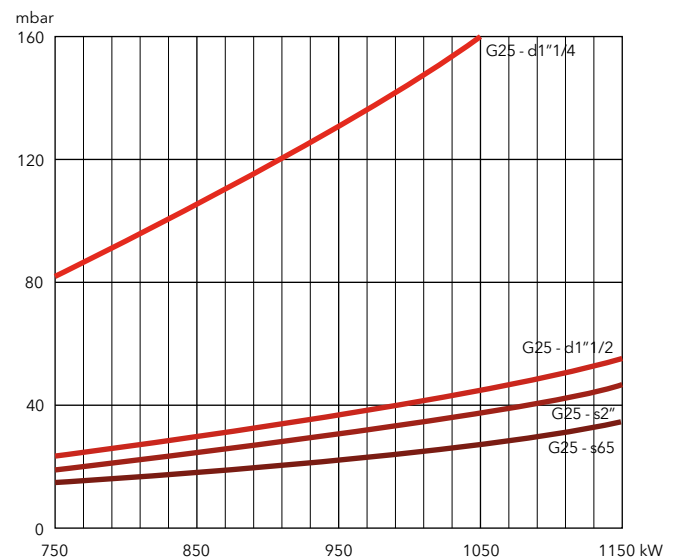

LPG

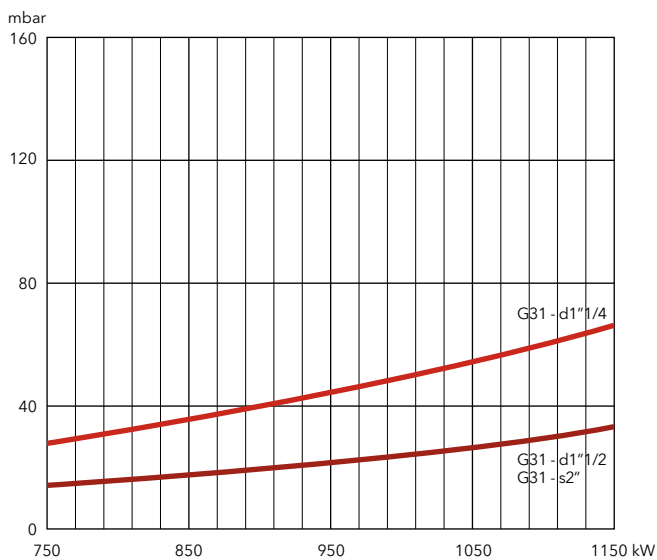

VG6.1600 DP / VG6.2100 DP

300 ... 1900 kW

Two stage progressive/modulating pneumatic



- **Fuels:** natural gas (G20/G25, $H_u = 8,83...10,35 \text{ kWh/m}^3$); LPG (G31, $H_u = 25,89 \text{ kWh/m}^3$)
- **Emissions:** NOx < 70 mg/kWh (NCV), Low NOx class 3 burners according to EN676
- **Operation:** two stage progressive or modulating with the installation of a power regulator and dedicated probes (see page 198)
- **Protection level:** IP 21

TECHNICAL DATA

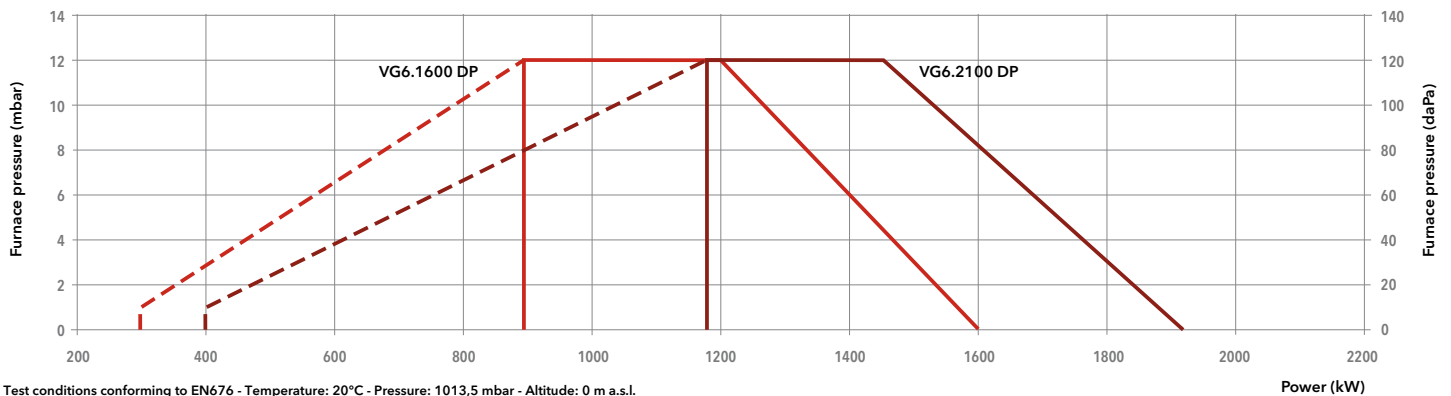

| Model | VG6.1600 DP /TC | | | VG6.2100 DP /TC | | |
|-------------------------------|----------------------------|---------|---------|----------------------------|---------|---------|
| Operation range | (300) 890 - 1600 kW | | | (400) 1180 - 1900 kW | | |
| Gas pressure | 20 - 300 mbar | | | 20 - 300 mbar | | |
| Control box / flame detection | TCG 5.. / IRD 1020.1 | | | TCG 5.. / IRD 1020.1 | | |
| Fan motor | 230/400 V - 50 Hz - 2,2 kW | | | 230/400 V - 50 Hz - 2,5 kW | | |
| Electrical consumption | 76 + 2325 W | | | 74 + 2622 W | | |
| Acoustic level (LpA) | 77,2 dB(A) | | | 79 dB(A) | | |
| CE certificate | 1312 CN 5685 | | | 1312 CN 5685 | | |
| Head length | KN | KL | KM | KN | KL | KM |
| Complete burner code | VGD 40-080 s80-DN80/TC | - | - | 3833757 | 3833758 | 3833759 |
| | VGD 40-065 s65-DN65/TC | 3833745 | 3833746 | 3833747 | 3833760 | 3833762 |
| | VGD 20-5011 s2"-Rp2"/TC | 3833748 | 3833749 | 3833750 | 3833763 | 3833764 |
| | MB-VEF 420 d1"1/2-Rp2"/TC | 3833751 | 3833752 | 3833753 | 3833766 | 3833767 |
| | MB-VEF 412 d1"1/4-Rp2"/TC | 3833754 | 3833755 | 3833756 | 3833769 | 3833770 |

OTHER AVAILABLE VERSIONS

- 60 60 Hz version
- V_{ent} Versions for continuous ventilation and post-ventilation

SCOPE OF SUPPLY

The burner is delivered in its package complete with:

- 1 burner head with flange seal and securing screws
- 1 compact gas train with gas filter; the gas filter is built-in for threaded valves (up to 2") and separated for flanged ones (DN65/80/100)
- 1 bag containing installation fittings
- 1 bag containing technical documentation (instruction manual, technical data, electrical diagram, exploded view and spare parts list)

DIMENSIONS (mm)

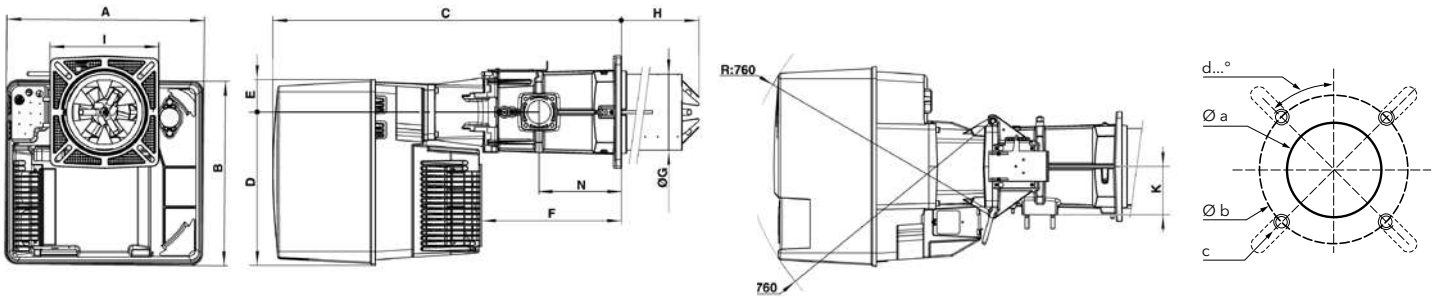

| A | B | C | D | E | F | ØG | H | | | I | K | N |
|-----|-----|------|-----|----|-----|-----|-----|-----|-----|---------|-----|-----|
| | | | | | | | KN | KM | KL | | | |
| 592 | 553 | 1050 | 456 | 97 | 421 | 227 | 360 | 460 | 560 | 326x335 | 144 | 247 |

| Øa (mm) | b (mm) | c | d |
|---------|---------|-----|-----|
| 250 | 300-400 | M12 | 45° |

Gas trains

Gas train "d":

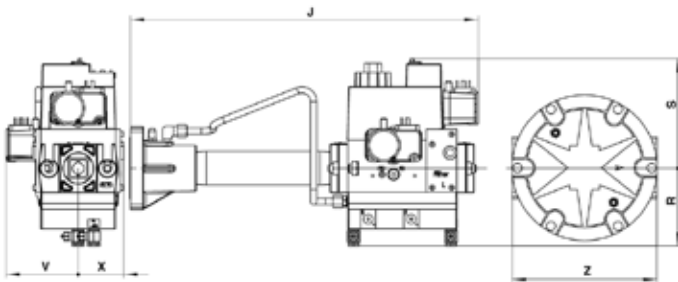

| Model | J | R | S | V | X | Z |
|----------------|-----|-----|-----|----|----|-----|
| d1"1/2-Rp2"/TC | 540 | 123 | 190 | 95 | 55 | - |
| d1"1/4-Rp2"/TC | 450 | 100 | 141 | 95 | 58 | 186 |

Gas train "s":

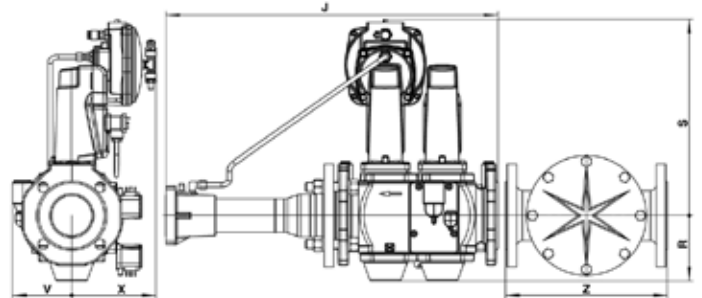

| Model | J | R | S | V | X | Z |
|-------------|-----|-----|-----|-----|-----|-----|
| s80-DN80/TC | 600 | 120 | 350 | 110 | 150 | 320 |
| s65-DN65/TC | 600 | 135 | 360 | 110 | 150 | 290 |
| s2"-Rp2"/TC | 612 | 103 | 330 | 110 | 150 | 186 |

PACKAGING

The burner is delivered on a pallet in three packages containing:

- burner housing
- combustion head
- gas train and filter

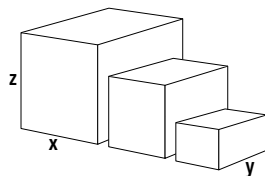

| Component | | Dimensions (mm) | | | Gross weight (kg) |
|-----------------|----------------|-----------------|-----|-----|-------------------|
| | | X | Y | Z | |
| Burner body | VG6.1600 DP | 800 | 600 | 850 | 67,8 |
| | VG6.2100 DP | 800 | 600 | 850 | 69,2 |
| Combustion head | KN | 1000 | 380 | 420 | 26,7 |
| | KL | 1100 | 380 | 430 | 29,4 |
| | KM | 1100 | 380 | 430 | 28 |
| Gas train | s80-DN80/TC | 790 | 600 | 500 | 39 |
| | s65-DN65/TC | 790 | 600 | 500 | 29,4 |
| | s2"-Rp2"/TC | 790 | 600 | 500 | 16,5 |
| | d1"1/2-Rp2"/TC | 670 | 550 | 380 | 14,3 |
| | d1"1/4-Rp2"/TC | 670 | 550 | 380 | 13 |

VG6.1600 DP / VG6.2100 DP

300 ... 1900 kW

Two stage progressive/modulating pneumatic

PRESSURE LOSS [BURNER HEAD + GAS TRAIN] (mbar)

VG6.1600 DP

| Burner output (kW) | Natural gas G20 Hi = 10,35 kWh/m ³ | | | | Natural gas G25 Hi = 8,83 kWh/m ³ | | | | LPG G31 Hi = 25,89 kWh/m ³ | | |
|--------------------|---|-------------|----------|----------|--|-------------|----------|----------|---------------------------------------|-------------|----------|
| | d1"1/4-Rp2" | d1"1/2-Rp2" | s2"-Rp2" | s65-DN65 | d1"1/4-Rp2" | d1"1/2-Rp2" | s2"-Rp2" | s65-DN65 | d1"1/4-Rp2" | d1"1/2-Rp2" | s2"-Rp2" |
| 900 | 53 | 18 | 9 | 7 | 77 | 27 | 14 | 9 | 20 | 8 | 6 |
| 1000 | 66 | 23 | 12 | 8 | 93 | 33 | 17 | 12 | 24 | 10 | 7 |
| 1100 | 80 | 28 | 14 | 10 | 113 | 40 | 21 | 14 | 29 | 12 | 9 |
| 1200 | 95 | 33 | 17 | 12 | 136 | 48 | 25 | 17 | 35 | 15 | 10 |
| 1300 | 112 | 39 | 20 | 14 | 158 | 57 | 29 | 20 | 41 | 17 | 12 |
| 1400 | 129 | 45 | 23 | 16 | 182 | 66 | 34 | 23 | 47 | 20 | 14 |
| 1500 | 148 | 51 | 26 | 19 | 209 | 76 | 39 | 27 | 54 | 23 | 16 |
| 1600 | 168 | 58 | 30 | 21 | 238 | 86 | 45 | 30 | 62 | 26 | 19 |

Natural gas G20

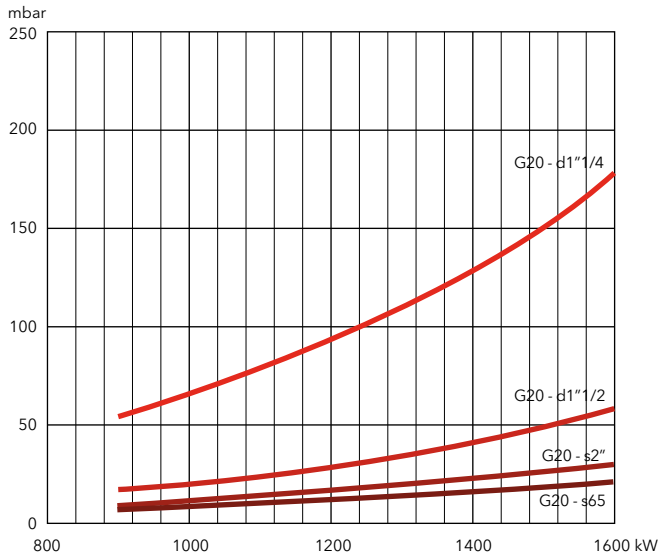

Natural gas G25

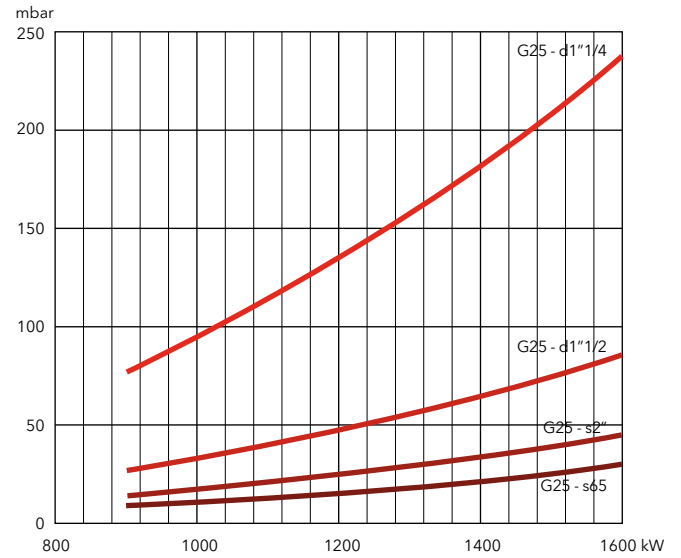

LPG

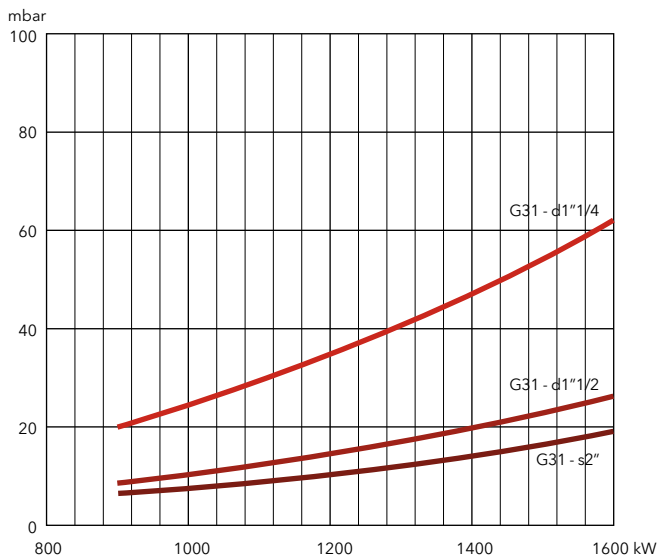



PRESSURE LOSS [BURNER HEAD + GAS TRAIN] (mbar)

VG6.2100 DP

| Burner output (kW) | Natural gas G20 Hi = 10,35 kWh/m ³ | | | | | Natural gas G25 Hi = 8,83 kWh/m ³ | | | | | LPG G31 Hi = 25,89 kWh/m ³ | | |
|--------------------|---|------------|----------|----------|----------|--|------------|----------|----------|----------|---------------------------------------|------------|----------|
| | d1"1/4-Rp2 | d1"1/2-Rp2 | s2"-Rp2" | s65-DN65 | s80-DN80 | d1"1/4-Rp2 | d1"1/2-Rp2 | s2"-Rp2" | s65-DN65 | s80-DN80 | d1"1/4-Rp2 | d1"1/2-Rp2 | s2"-Rp2" |
| 1200 | 70 | 28 | 17 | 12 | 10 | 81 | 32 | 20 | 14 | 12 | 39 | 13 | 8 |
| 1300 | 82 | 32 | 20 | 14 | 12 | 95 | 38 | 24 | 16 | 14 | 46 | 15 | 10 |
| 1400 | 95 | 37 | 24 | 16 | 14 | 110 | 44 | 28 | 19 | 16 | 53 | 17 | 11 |
| 1500 | 109 | 43 | 27 | 18 | 16 | 128 | 50 | 32 | 21 | 19 | 61 | 20 | 13 |
| 1600 | 124 | 49 | 31 | 21 | 18 | 144 | 57 | 36 | 24 | 21 | 69 | 23 | 15 |
| 1700 | 140 | 55 | 35 | 24 | 21 | 163 | 64 | 40 | 27 | 24 | 78 | 26 | 17 |
| 1800 | 157 | 61 | 39 | 26 | 23 | 183 | 71 | 45 | 30 | 27 | 87 | 29 | 19 |
| 1900 | 175 | 69 | 43 | 29 | 25 | 204 | 79 | 50 | 34 | 31 | 97 | 32 | 21 |

Natural gas G20

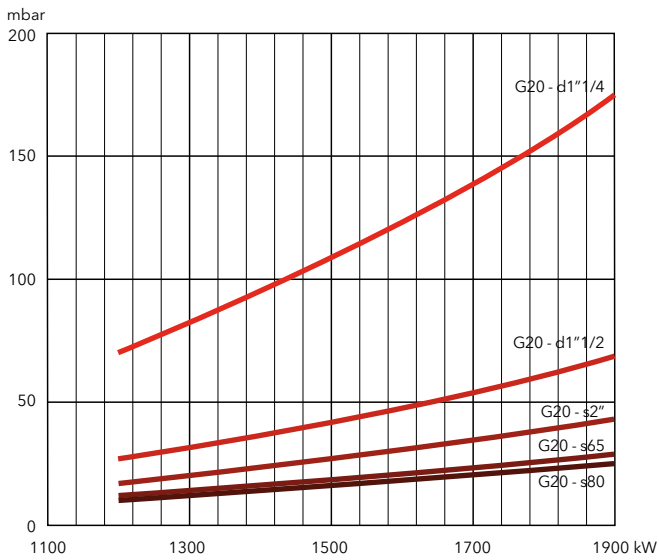

Natural gas G25

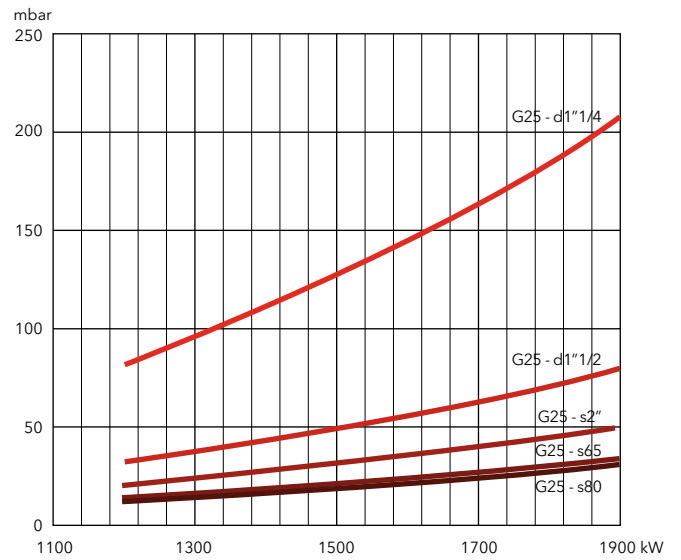

LPG

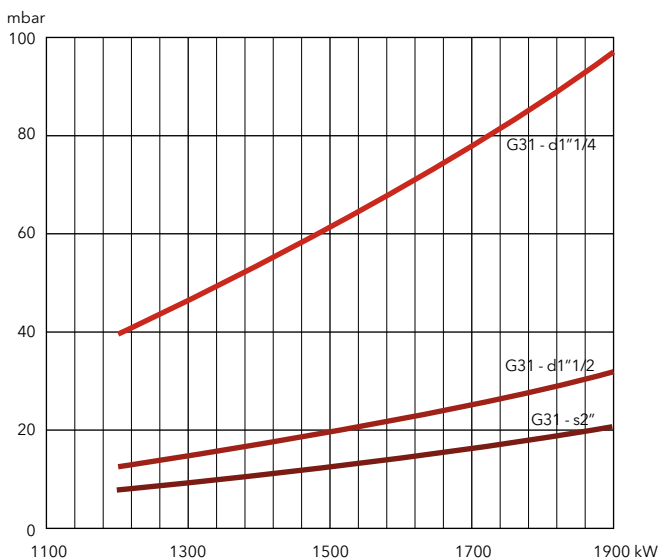

VG2.205 V E

65 ... 205 kW

2 stage progressive/modulating pneumatic + fan speed control

- **Fuels:** natural gas (G20/G25, $H_u = 8,83...10,35 \text{ kWh/m}^3$); LPG (G31, $H_u = 25,89 \text{ kWh/m}^3$)
- **Emissions:** $\text{NO}_x < 56 \text{ mg/kWh}$ (GCV), burners compliant with ErP Directive
- **Operation:** two stage progressive or modulating with the installation of a power regulator and dedicated probes (see page 198) and fan speed control
- **Protection level:** IP 21



TECHNICAL DATA

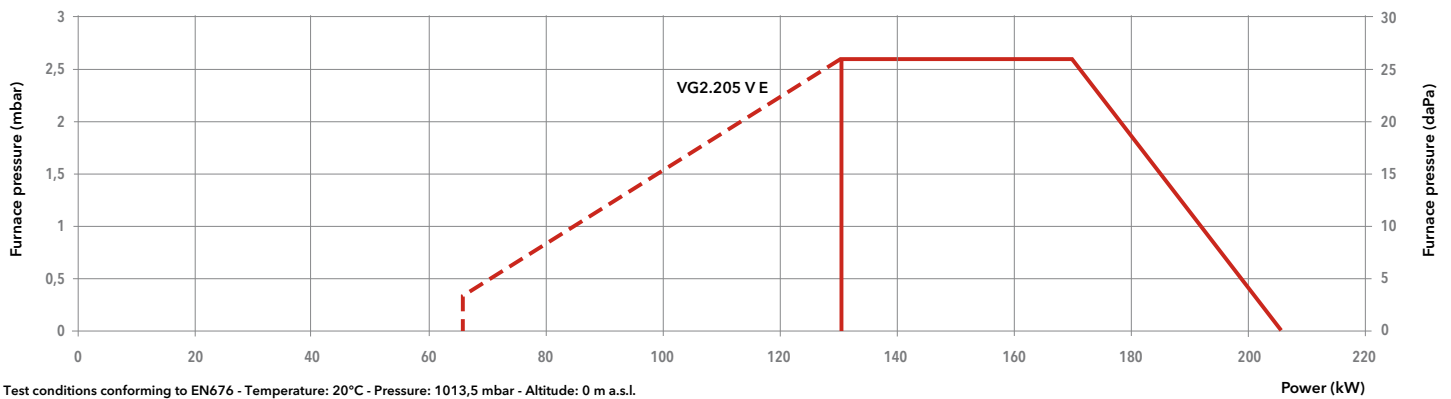

| Model | VG2.205 V E | |
|---|--|---------|
| Operation range | (65) 130 - 205 kW | |
| Gas pressure | 20 - 40 mbar for MB-VEF 412; 40 - 100 mbar for d345; 100 - 360 mbar for d346 | |
| Control box / flame detection | TCG5.../ionization | |
| Fan motor | 230 V - 50 Hz - 250 W | |
| Electrical consumption (max/min/stand-by) | 302 W / 267 W / 4 W | |
| Acoustic level (LpA) | 65 dB(A) | |
| CE certificate | 0476 CT 2423 | |
| Head length | KN | KL |
| Complete burner code | MB-VEF 412 d1"1/4-Rp1"1/4 | 3836436 |
| | MB-VEF 407 d345-3/4"-Rp3/4" | 3836438 |
| | MB-VEF 407 d346-3/4"-Rp3/4" | 3836440 |
| | | 3836437 |
| | | 3836439 |
| | | 3836441 |

OTHER AVAILABLE VERSIONS

Versions for continuous ventilation and post-ventilation

SCOPE OF SUPPLY

The burner is delivered in its package complete with:

- 1 gas connection flange
- 1 compact gas train with gas filter; the gas filter is built-in for threaded valves (up to 2") and separated for flanged ones (DN65/80/100)
- 1 burner flange with insulation
- 1 bag containing installation fittings
- 1 bag containing technical documentation (instruction manual, technical data, electrical diagram, exploded view and spare parts list)



DIMENSIONS (mm)

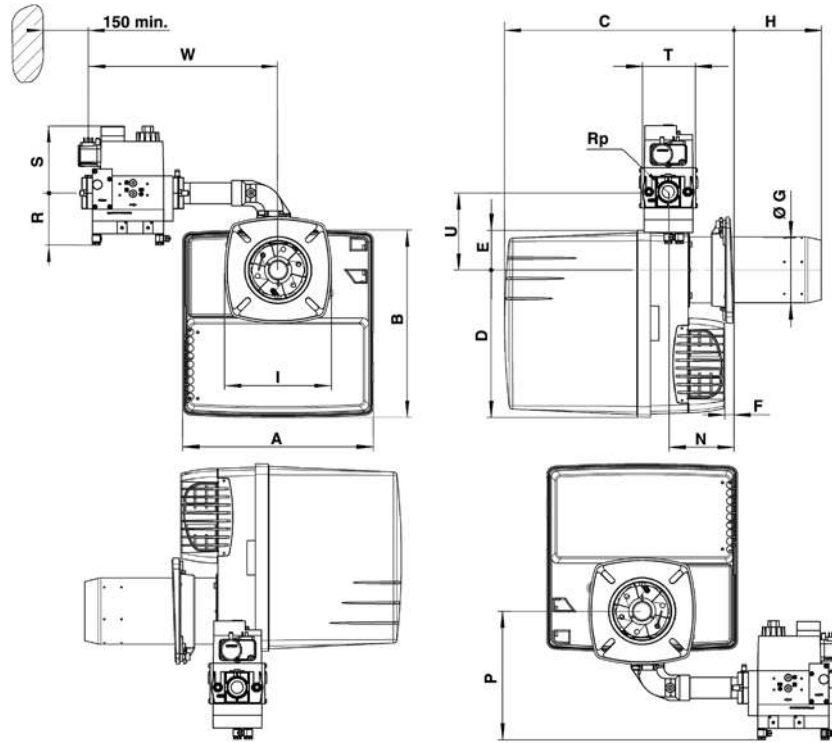

| Gas train model | A | B | C | | D | E | F min | ØG | H | | I | N min | P | Rp | R | S | T | U | W |
|-----------------|-----|-----|-----------|-----------|-----|----|-------|-----|----------|----------|-----|-------|-----|-------|----|-----|-----|-----|-----|
| | | | KN | KL | | | | | KN | KL | | | | | | | | | |
| d1"1/4-Rp1"1/4 | 331 | 325 | 398...518 | 398...638 | 256 | 69 | 15 | 125 | 30...150 | 30...270 | 185 | 113 | 188 | 1"1/4 | 80 | 175 | 145 | 133 | 380 |
| d3/4"-Rp3/4" | 331 | 325 | 398...518 | 398...638 | 256 | 69 | 15 | 125 | 30...150 | 30...270 | 185 | 113 | 179 | 3/4" | 70 | 160 | 120 | 133 | 345 |

Connecting flange

| Øa (mm) | b (mm) | c | d |
|---------|---------|----|-----|
| 130-145 | 160-185 | M8 | 45° |

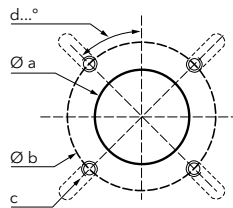

PACKAGING

The burner is delivered in a single package containing all the components

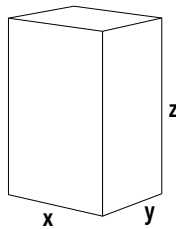

| Burner | Dimensions (mm) | | | Gross weight (kg) |
|---------|-----------------|-----|-----|-------------------|
| | X | Y | Z | |
| VG2.205 | 400 | 400 | 760 | 26 |

VG3.290 V E / VG3.350 V E

95 ... 350 kW

Two stage progressive/modulating pneumatic + fan speed control

- **Fuels:** natural gas (G20/G25, $H_u = 8,83...10,35 \text{ kWh/m}^3$); LPG (G31, $H_u = 25,89 \text{ kWh/m}^3$)
- **Emissions:** $\text{NO}_x < 56 \text{ mg/kWh}$ (GCV), burners compliant with ErP Directive
- **Operation:** two stage progressive or modulating with the installation of a power regulator and dedicated probes (see page 198) and fan speed control
- **Protection level:** IP 21



TECHNICAL DATA

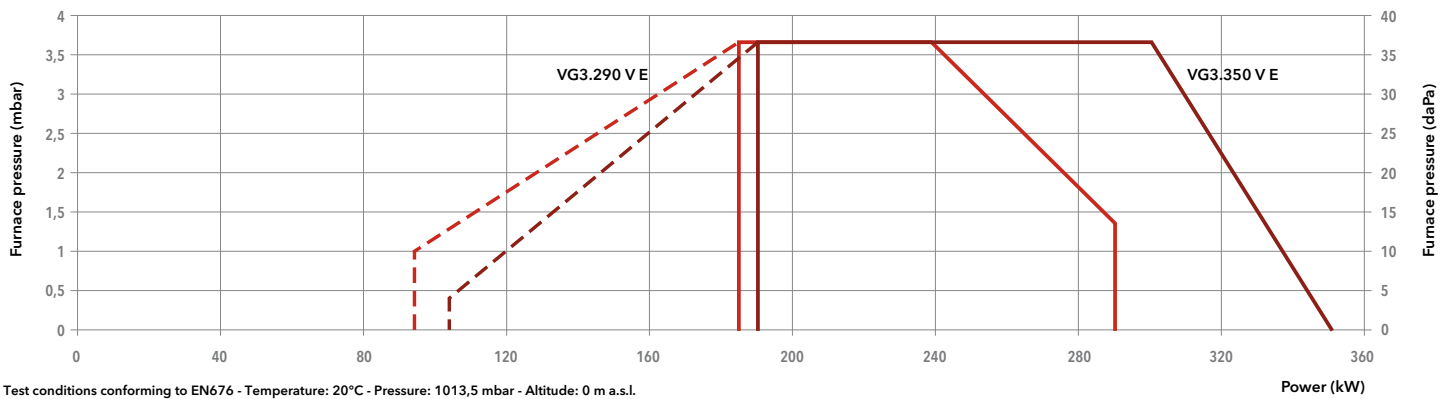

| Model | VG3.290 V E | | VG3.350 V E | |
|---|----------------------------|---------|-----------------------|---------|
| Operation range | (95) 185 - 290 kW | | (105) 190 - 350 kW | |
| Gas pressure | 20 - 360 mbar | | 20 - 360 mbar | |
| Control box / flame detection | TCG5... / ionization | | TCG5... / ionization | |
| Fan motor | 230 V - 50 Hz - 250 W | | 230 V - 50 Hz - 300 W | |
| Electrical consumption (max/min/stand-by) | 465 W / 441 W / 4 W | | 583 W / 583 W / 4 W | |
| Acoustic level (LpA) | 67 dB(A) | | 69 dB(A) | |
| CE certificate | 0476 CT 2423 | | 0476 CT 2423 | |
| Head length | KN | KL | KN | KL |
| Complete burner code | MB-VEF 420 d1"1/2-Rp2" | - | 3836446 | 3836447 |
| | MB-VEF 412 d1"1/4-Rp1"1/4" | 3836442 | 3836448 | 3836449 |
| | MB-VEF 407 d3/4"-Rp1" | 3836444 | 3836445 | 3836450 |

OTHER AVAILABLE VERSIONS

- TC** Version with tightness control
- Vent** Versions for continuous ventilation and post-ventilation

SCOPE OF SUPPLY

The burner is delivered in its package complete with:

- 1 burner head with flange seal and securing screws
- 1 compact gas train with gas filter; the gas filter is built-in for threaded valves (up to 2") and separated for flanged ones (DN65/80/100)
- 1 bag containing installation fittings
- 1 bag containing technical documentation (instruction manual, technical data, electrical diagram, exploded view and spare parts list)



DIMENSIONS (mm)

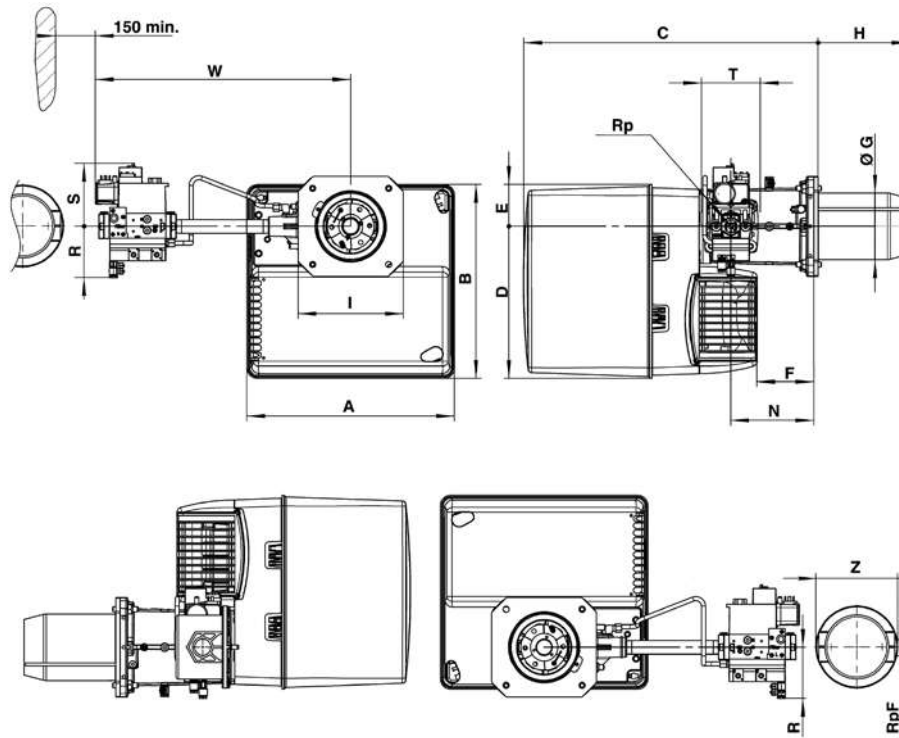

| Gas train model | A | B | C | D | E | F | ØG | H | | I | N | Rp | R | S | T | W | RpF | Z |
|-----------------|-----|-----|-----|-----|----|-----|-----|-----|-----|---------|-----|-------|-----|-----|-----|-----|-----|-----|
| | | | | | | | | KN | KL | | | | | | | | | |
| d1"1/2-Rp2" | 406 | 379 | 576 | 297 | 82 | 120 | 130 | 180 | 320 | 195x205 | 170 | 2" | 100 | 185 | 100 | 603 | - | - |
| d1"1/4-Rp1"1/4 | 406 | 379 | 576 | 297 | 82 | 120 | 130 | 180 | 320 | 195x205 | 170 | 1"1/4 | 80 | 175 | 145 | 526 | - | - |
| d3/4"-Rp1" | 406 | 379 | 576 | 297 | 82 | 120 | 130 | 180 | 320 | 195x205 | 170 | 1" | 70 | 160 | 120 | 479 | 1" | 160 |

Connecting flange

| Øa (mm) | b (mm) | c | d |
|---------|---------|-----|-----|
| 155-190 | 175-220 | M10 | 45° |

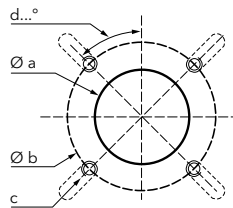

PACKAGING

The burner is delivered on a pallet in three packages containing:

- burner housing
- combustion head
- gas train and filter

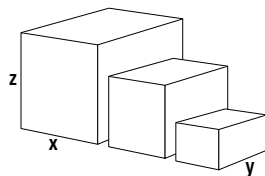

| Component | | Dimensions (mm) | | | Gross weight (kg) |
|-----------------|----------------|-----------------|-----|-----|-------------------|
| | | X | Y | Z | |
| Burner body | VG3.290 V E | 440 | 400 | 520 | 21 |
| | VG3.350 V E | 440 | 400 | 520 | 22 |
| Combustion head | KN | 650 | 210 | 260 | 6 |
| | KL | 780 | 210 | 260 | 7 |
| Gas train | d1"1/2-Rp2" | 670 | 550 | 380 | 12 |
| | d1"1/4-Rp1"1/4 | 600 | 400 | 240 | 11 |
| | d3/4"-Rp1" | 600 | 400 | 240 | 7 |

VG3.290 V E / VG3.350 V E

95 ... 350 kW

Two stage progressive/modulating pneumatic + fan speed control

PRESSURE LOSS [BURNER HEAD + GAS TRAIN] (mbar)

VG3.290 V E

| Burner output (kW) | Natural gas G20 Hi = 10,35 kWh/m ³ | | Natural gas G25 Hi = 8,83 kWh/m ³ | | LPG G31 Hi = 25,89 kWh/m ³ | |
|--------------------|---|----------------|--|----------------|---------------------------------------|----------------|
| | d3/4"-Rp1" | d1"1/4-Rp1"1/4 | d3/4"-Rp1" | d1"1/4-Rp1"1/4 | d3/4"-Rp1" | d1"1/4-Rp1"1/4 |
| 190 | 17 | 9 | 22 | 11 | 11 | 7 |
| 210 | 18 | 9 | 24 | 12 | 12 | 7 |
| 230 | 20 | 9 | 27 | 12 | 12 | 7 |
| 250 | 22 | 10 | 31 | 13 | 13 | 8 |
| 270 | 25 | 11 | 35 | 15 | 14 | 8 |
| 290 | 29 | 13 | 40 | 16 | 16 | 9 |

Natural gas G20

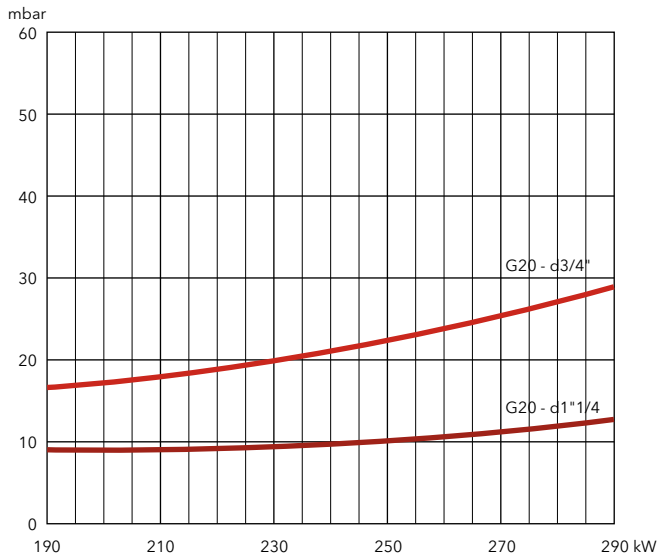

Natural gas G25

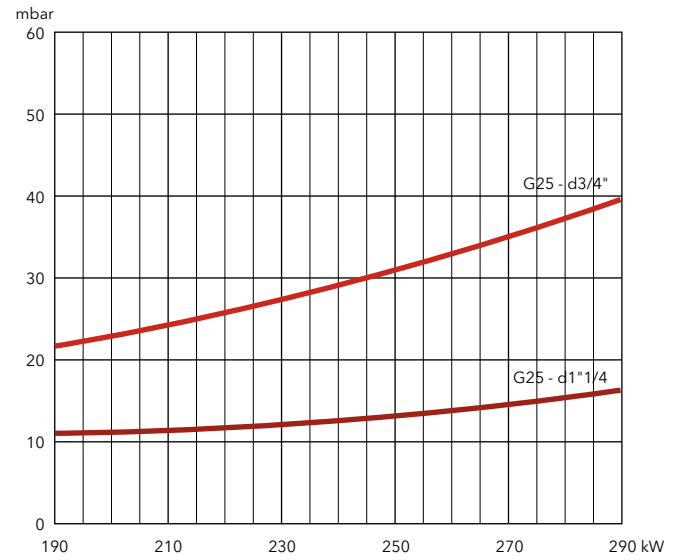

LPG

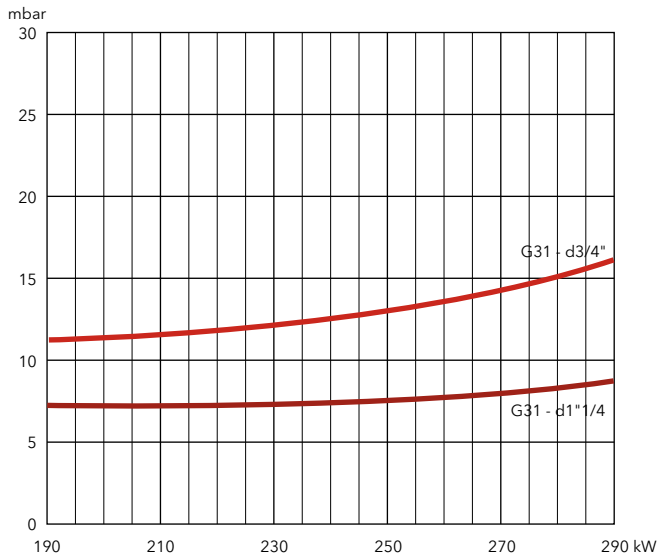



PRESSURE LOSS [BURNER HEAD + GAS TRAIN] (mbar)

VG3.350 V E

| Burner output (kW) | Natural gas G20 Hi = 10,35 kWh/m ³ | | | Natural gas G25 Hi = 8,83 kWh/m ³ | | | LPG G31 |
|--------------------|---|----------------|-------------|--|----------------|-------------|------------|
| | d3/4"-Rp1" | d1"1/4-Rp1"1/4 | d1"1/2-Rp2" | d3/4"-Rp1" | d1"1/4-Rp1"1/4 | d1"1/2-Rp2" | d3/4"-Rp1" |
| 190 | 13 | 6 | 6 | 19 | 8 | 8 | 8 |
| 230 | 17 | 7 | 7 | 26 | 11 | 10 | 12 |
| 270 | 23 | 9 | 8 | 35 | 15 | 13 | 15 |
| 310 | 29 | 11 | 10 | 44 | 18 | 16 | 18 |
| 350 | 36 | 14 | 12 | 54 | 22 | 19 | 22 |

Natural gas G20

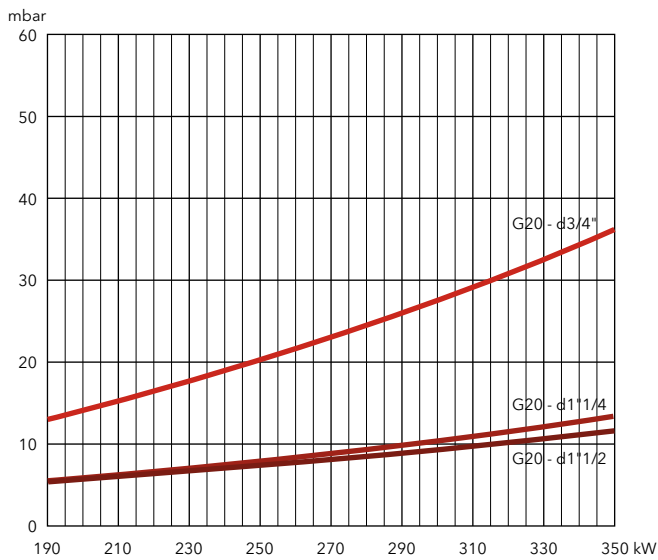

Natural gas G25

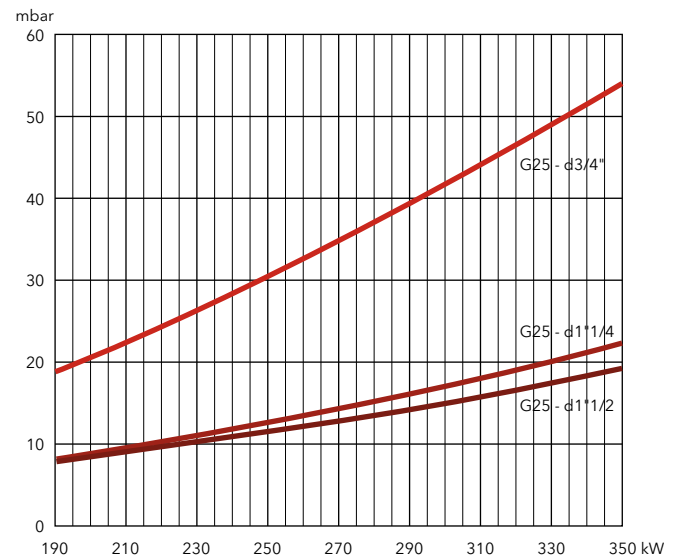

LPG

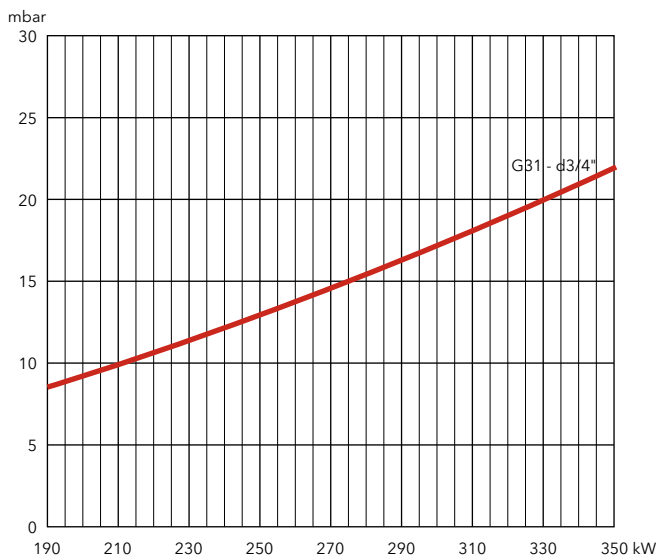

VG4.440 V E

110 ... 440 kW

Two stage progressive/modulating pneumatic + fan speed control



- **Fuels:** natural gas (G20/G25, $H_u = 8,83...10,35 \text{ kWh/m}^3$); LPG (G31, $H_u = 25,89 \text{ kWh/m}^3$)
- **Emissions:** $\text{NO}_x < 56 \text{ mg/kWh}$ (GCV), burners compliant with ErP Directive
- **Operation:** two stage progressive or modulating with the installation of a power regulator and dedicated probes (see page 198) and fan speed control
- **Protection level:** IP 21

TECHNICAL DATA

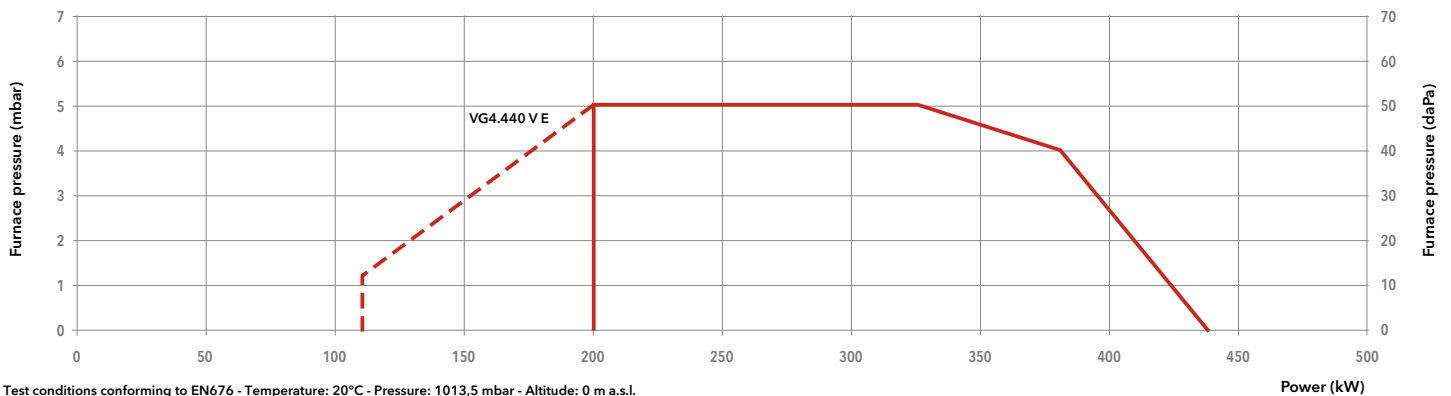

| Model | | VG4.440 V E | |
|---|------------|-----------------------|---------|
| Operation range | | (110) 200 - 440 kW | |
| Gas pressure | | 20 - 360 mbar | |
| Control box / flame detection | | TCG5.../ionization | |
| Fan motor | | 230 V - 50 Hz - 420 W | |
| Electrical consumption (max/min/stand-by) | | 606 W / 569 W / 4 W | |
| Acoustic level (LpA) | | 70 dB(A) | |
| CE certificate | | 0476 CT 2423 | |
| Head length | | KN | KL |
| Complete burner code | MB-VEF 420 | d1"1/2-Rp2" | 3836452 |
| | MB-VEF 412 | d1"1/4-Rp1"1/4 | 3836454 |
| | MB-VEF 407 | d3/4"-Rp1" | 3836456 |
| | | | 3836453 |
| | | | 3836455 |
| | | | 3836457 |

OTHER AVAILABLE VERSIONS

- TC** Version with tightness control
- Vent** Versions for continuous ventilation and post-ventilation

SCOPE OF SUPPLY

The burner is delivered in its package complete with:

- 1 burner head with flange seal and securing screws
- 1 compact gas train with gas filter; the gas filter is built-in for threaded valves (up to 2") and separated for flanged ones (DN65/80/100)
- 1 bag containing installation fittings
- 1 bag containing technical documentation (instruction manual, technical data, electrical diagram, exploded view and spare parts list)



DIMENSIONS (mm)

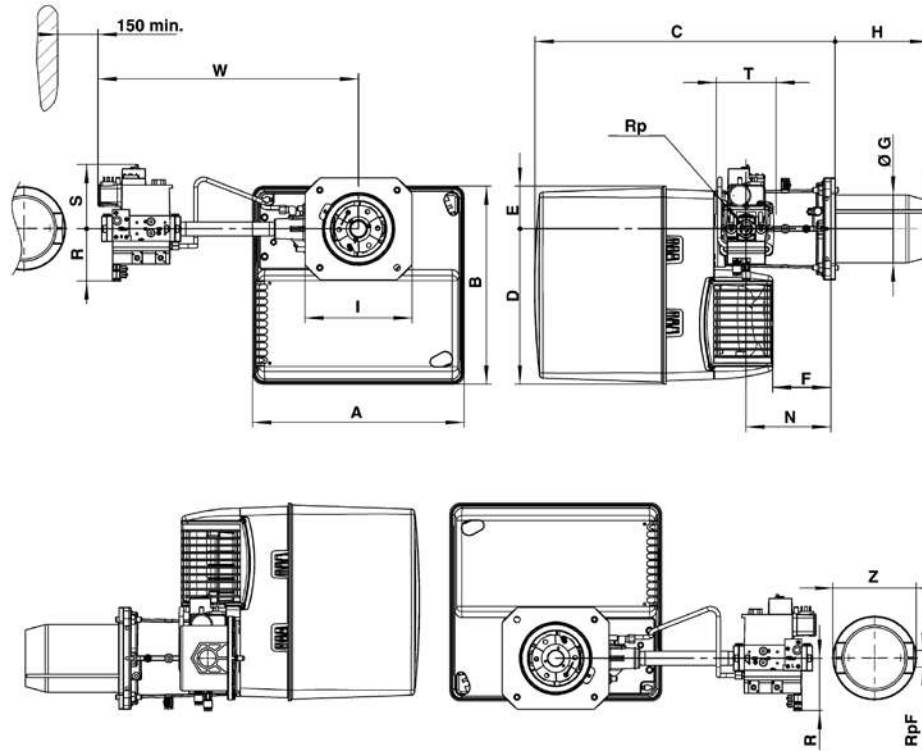

| Gas train model | A | B | C | D | E | F | ØG | H | | I | N | Rp | R | S | T | W | RpF | Z |
|-----------------|-----|-----|-----|-----|----|-----|-----|-----|-----|-----|-----|-------|-----|-----|-----|-----|-----|-----|
| | | | | | | | | KN | KL | | | | | | | | | |
| d1"1/2-Rp2" | 465 | 475 | 640 | 377 | 97 | 149 | 157 | 212 | 352 | 245 | 195 | 2" | 100 | 185 | 150 | 536 | - | - |
| d1"1/4-Rp1"1/4 | 465 | 475 | 640 | 377 | 97 | 149 | 157 | 212 | 352 | 245 | 195 | 1"1/4 | 80 | 175 | 151 | 489 | - | - |
| d3/4"-Rp1" | 465 | 475 | 640 | 377 | 97 | 149 | 157 | 212 | 352 | 245 | 195 | 1" | 70 | 160 | 132 | 489 | 1" | 160 |

Connecting flange

| Øa (mm) | b (mm) | c | d |
|---------|---------|-----|-----|
| 190-240 | 200-270 | M10 | 45° |

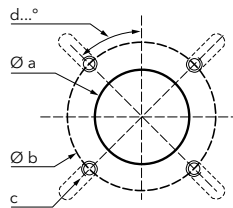

PACKAGING

The burner is delivered on a pallet in three packages containing:

- burner housing
- combustion head
- gas train and filter

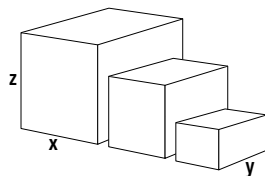

| Component | | Dimensions (mm) | | | Gross weight (kg) |
|-----------------|----------------|-----------------|-----|-----|-------------------|
| | | X | Y | Z | |
| Burner body | VG4.440 V E | 490 | 490 | 590 | 28,6 |
| | KN | 750 | 260 | 295 | 8,9 |
| Combustion head | KL | 895 | 260 | 295 | 10,1 |
| | d1"1/2-Rp2" | 670 | 550 | 380 | 12 |
| Gas train | d1"1/4-Rp1"1/4 | 600 | 400 | 240 | 11 |
| | d3/4"-Rp1" | 600 | 400 | 240 | 7 |

VG4.440 V E

110 ... 440 kW

Two stage progressive/modulating pneumatic + fan speed control

PRESSURE LOSS [BURNER HEAD + GAS TRAIN] (mbar)

VG4.440 V E

| Burner output (kW) | Natural gas G20 Hi = 10,35 kWh/m ³ | | | Natural gas G25 Hi = 8,83 kWh/m ³ | | |
|--------------------|---|----------------|-------------|--|----------------|-------------|
| | d3/4"-Rp1" | d1"1/4-Rp1"1/4 | d1"1/2-Rp2" | d3/4"-Rp1" | d1"1/4-Rp1"1/4 | d1"1/2-Rp2" |
| 240 | 19 | 8 | 7 | 27 | 11 | 10 |
| 280 | 24 | 9 | 8 | 35 | 13 | 11 |
| 320 | 30 | 11 | 9 | 42 | 15 | 12 |
| 360 | 37 | 13 | 11 | 51 | 18 | 15 |
| 400 | 44 | 15 | 13 | 64 | 22 | 17 |
| 440 | 51 | 18 | 15 | 78 | 25 | 20 |

Natural gas G20

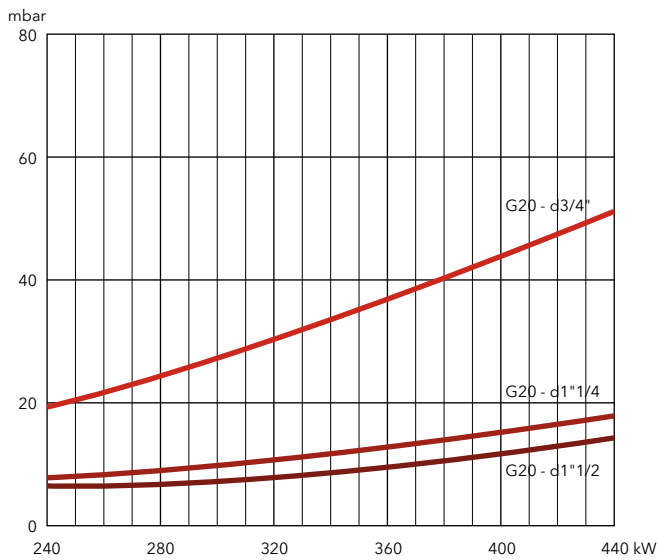

Natural gas G25

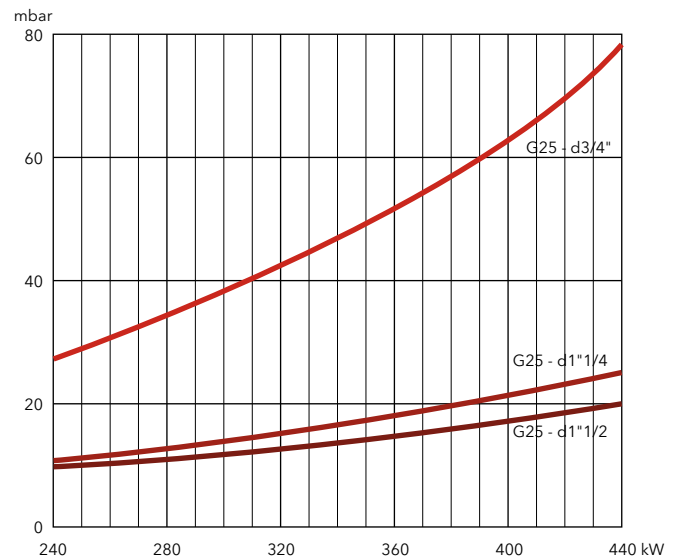



PRESSURE LOSS [BURNER HEAD + GAS TRAIN] (mbar)

| Burner output (kW) | LPG G31 Hi = 25,89 kWh/m ³ | |
|--------------------|---------------------------------------|----------------|
| | d3/4"-Rp1" | d1"1/4-Rp1"1/4 |
| 240 | 13 | 8 |
| 280 | 16 | 9 |
| 320 | 18 | 10 |
| 360 | 22 | 11 |
| 400 | 26 | 13 |
| 440 | 32 | 16 |

LPG

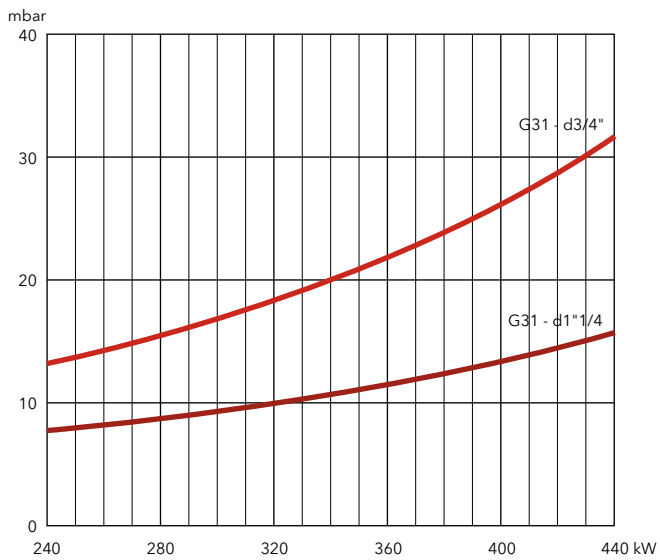

VG4.460 V / VG4.610 V

100 ... 610 kW

Two stage progressive/modulating pneumatic + fan speed control

- **Fuels:** natural gas, net calorific value 8,83...10,35 kWh/m³;
LPG, net calorific value 25,89 kWh/m³
- **Emissions:** NOx < 70 mg/kWh (NCV), Low NOx class 3 burners according to EN676
- **Operation:** two stage progressive or modulating with the installation of a power regulator and dedicated probes (see page 198) and fan speed control
- **Protection level:** IP 41



TECHNICAL DATA

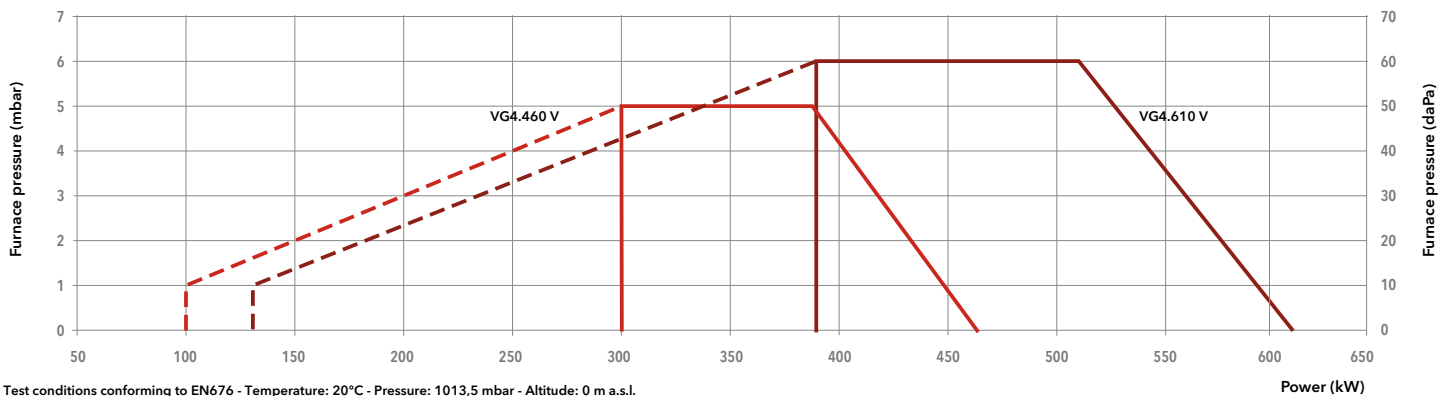

| Model | VG 4.460 V | | VG 4.610 V | |
|-------------------------------|---------------------------|---------|-----------------------|---------|
| Operation range | (100) 300 - 460 kW | | (130) 390 - 610 kW | |
| Gas pressure | 20 - 300 mbar | | 20 - 300 mbar | |
| Control box / flame detection | TCG5... / ionization | | TCG5... / ionization | |
| Fan motor | 230 V - 50 Hz - 420 W | | 230 V - 50 Hz - 750 W | |
| Electrical consumption | 68 + 522 W | | 68 + 720 W | |
| Acoustic level (LpA) | 70 dB(A) | | 71 dB(A) | |
| CE certificate | 1312 CL 5412 | | 1312 CL 5412 | |
| Head length | KN | KL | KN | KL |
| Complete burner code | MB-VEF 420 d1"1/2-Rp2" | 3833887 | 3833875 | 3833876 |
| | MB-VEF 412 d1"1/4-Rp1"1/4 | 3833891 | 3833879 | 3833880 |
| | MB-VEF 407 d3/4"-Rp1" | 3833895 | 3833883 | 3833884 |

OTHER AVAILABLE VERSIONS

- TC** Version with tightness control
- Vent** Versions for continuous ventilation and post-ventilation

SCOPE OF SUPPLY

The burner is delivered in its package complete with:

- 1 burner head with flange seal and securing screws
- 1 compact gas train with gas filter
- 1 bag containing installation fittings
- 1 bag containing technical documentation (instruction manual, technical data, electrical diagram, exploded view and spare parts list)



DIMENSIONS (mm)

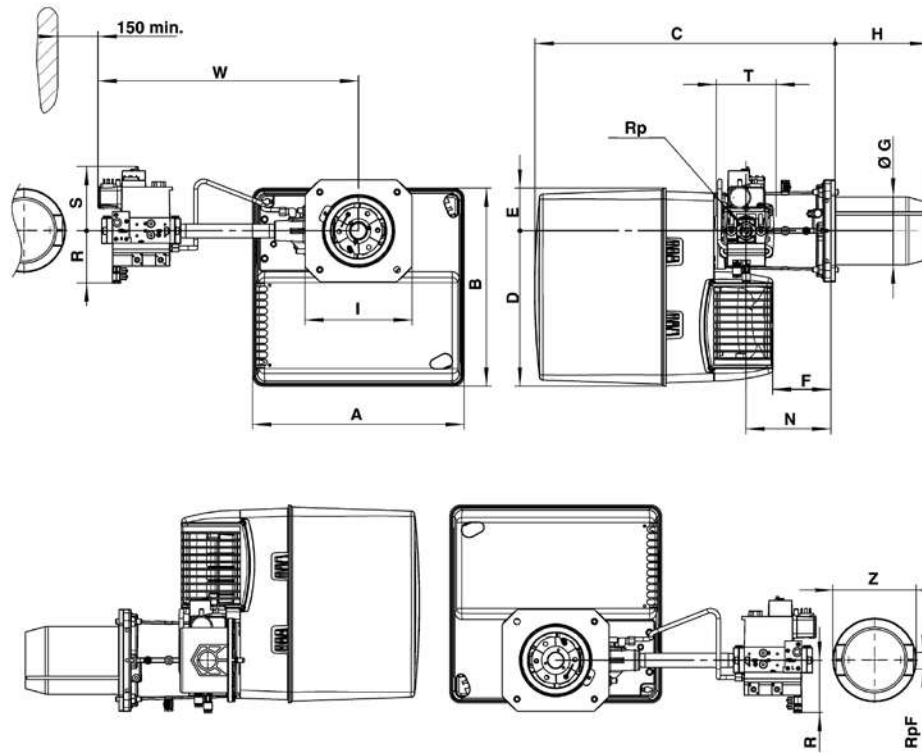

| Gas train model | A | B | C | D | E | F | ØG | H | | I | N | Rp | R | S | T | W | RpF | Z |
|-----------------|-----|-----|-----|-----|----|-----|-----|-----|-----|-----|-----|-------|-----|-----|-----|-----|-----|-----|
| | | | | | | | | KN | KL | | | | | | | | | |
| d1"1/2-Rp2" | 465 | 475 | 640 | 377 | 97 | 149 | 150 | 220 | 360 | 245 | 195 | 2" | 100 | 185 | 100 | 613 | - | - |
| d1"1/4-Rp1"1/4 | 465 | 475 | 640 | 377 | 97 | 149 | 150 | 220 | 360 | 245 | 195 | 1"1/4 | 80 | 175 | 145 | 536 | - | - |
| d3/4"-Rp1" | 465 | 475 | 640 | 377 | 97 | 149 | 150 | 220 | 360 | 245 | 195 | 1" | 70 | 160 | 120 | 489 | 1" | 160 |

Connecting flange

| Øa (mm) | b (mm) | c | d |
|---------|---------|-----|-----|
| 180-240 | 200-270 | M10 | 45° |

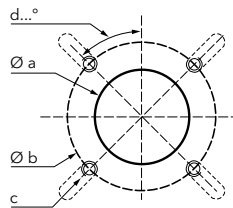

PACKAGING

The burner is delivered on a pallet in three packages containing:

- burner housing
- combustion head
- gas train and filter

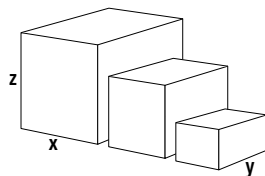

| Component | | Dimensions (mm) | | | Gross weight (kg) |
|-----------------|----------------|-----------------|-----|-----|-------------------|
| | | X | Y | Z | |
| Burner body | VG 4.460 V | 490 | 490 | 590 | 28,6 |
| | VG 4.610 V | 490 | 490 | 590 | 32,7 |
| Combustion head | KN | 750 | 260 | 295 | 8,9 |
| | KL | 895 | 260 | 295 | 10,1 |
| Gas train | d1"1/2-Rp2" | 670 | 550 | 380 | 12 |
| | d1"1/4-Rp1"1/4 | 600 | 400 | 240 | 11 |
| | d3/4"-Rp1" | 600 | 400 | 240 | 7 |

VG4.460 V / VG4.610 V

100 ... 610 kW

Two stage progressive/modulating pneumatic + fan speed control

PRESSURE LOSS [BURNER HEAD + GAS TRAIN] (mbar)

VG 4.460 V

| Burner output (kW) | Natural gas G20 Hi = 10,35 kWh/m ³ | | Natural gas G25 Hi = 8,83 kWh/m ³ | | | LPG G31 Hi = 25,89 kWh/m ³ | |
|--------------------|---|----------------|--|----------------|-------------|---------------------------------------|----------------|
| | d3/4"-Rp1" | d1"1/4-Rp1"1/4 | d3/4"-Rp1" | d1"1/4-Rp1"1/4 | d1"1/2-Rp2" | d3/4"-Rp1" | d1"1/4-Rp1"1/4 |
| 300 | 40 | 8 | 59 | 11 | 6 | 18 | 8 |
| 350 | 54 | 10 | 81 | 15 | 9 | 24 | 11 |
| 400 | 70 | 14 | 106 | 19 | 12 | 31 | 14 |
| 450 | 89 | 17 | 134 | 24 | 15 | 40 | 18 |
| 510 | 114 | 22 | 172 | 31 | 19 | 51 | 23 |

Natural gas G20

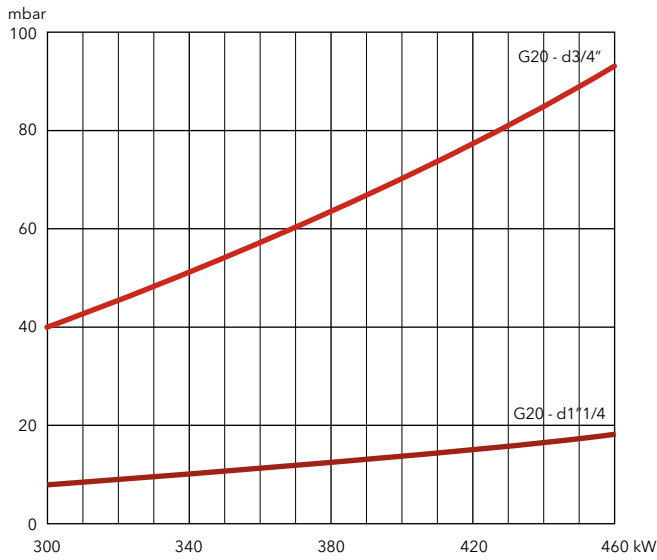

Natural gas G25

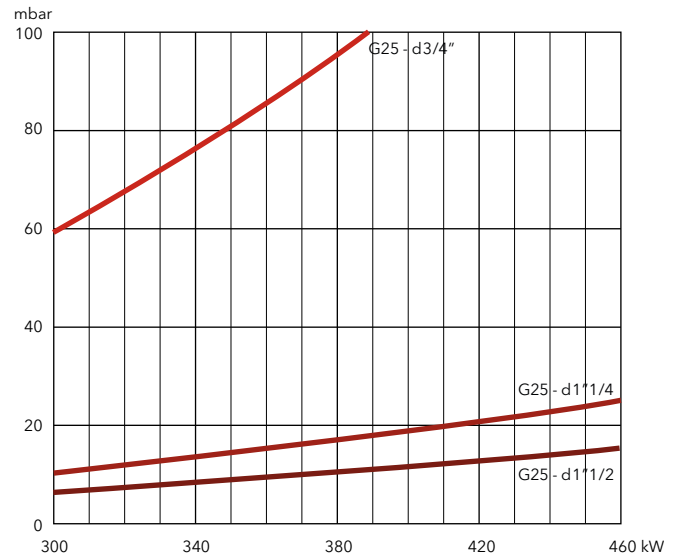

LPG

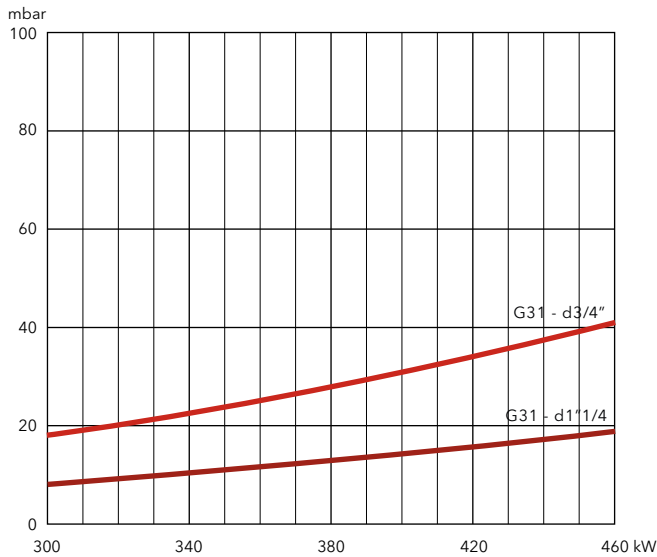



PRESSURE LOSS [BURNER HEAD + GAS TRAIN] (mbar)

VG 4.610 V

| Burner output (kW) | Natural gas G20 Hi = 10,35 kWh/m ³ | | | Natural gas G25 Hi = 8,83 kWh/m ³ | | | LPG G31 Hi = 25,89 kWh/m ³ | |
|--------------------|---|----------------|-------------|--|----------------|-------------|---------------------------------------|----------------|
| | d3/4"-Rp1" | d1"1/4-Rp1"1/4 | d1"1/2-Rp2" | d3/4"-Rp1" | d1"1/4-Rp1"1/4 | d1"1/2-Rp2" | d3/4"-Rp1" | d1"1/4-Rp1"1/4 |
| 350 | 53 | 9 | 6 | 78 | 13 | 7 | 25 | 8 |
| 400 | 70 | 12 | 8 | 102 | 17 | 9 | 32 | 10 |
| 450 | 88 | 16 | 10 | 129 | 21 | 11 | 41 | 13 |
| 500 | 109 | 19 | 12 | 159 | 26 | 14 | 50 | 16 |
| 550 | 132 | 23 | 15 | 192 | 32 | 17 | 61 | 20 |
| 610 | 162 | 29 | 18 | 236 | 39 | 20 | 75 | 24 |

Natural gas G20

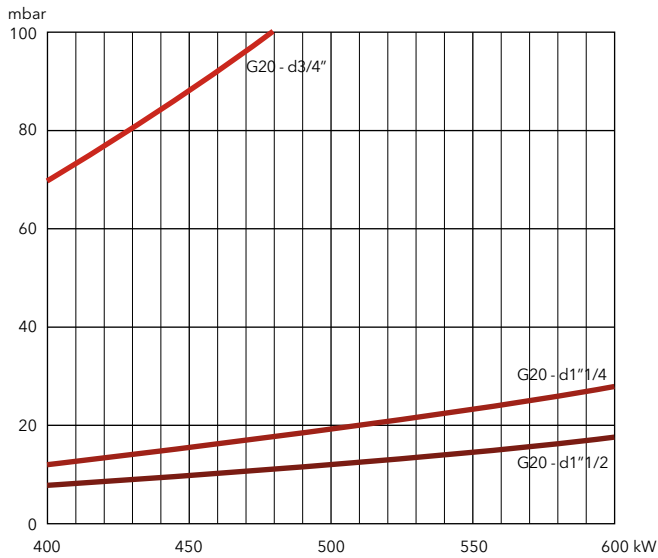

Natural gas G25

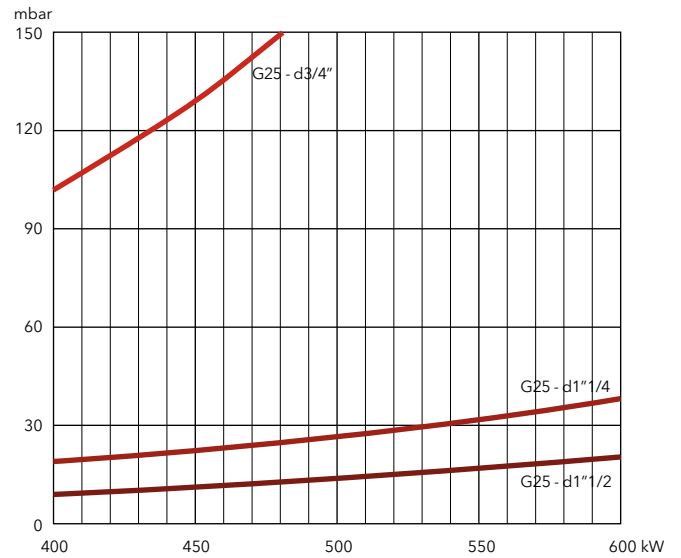

LPG

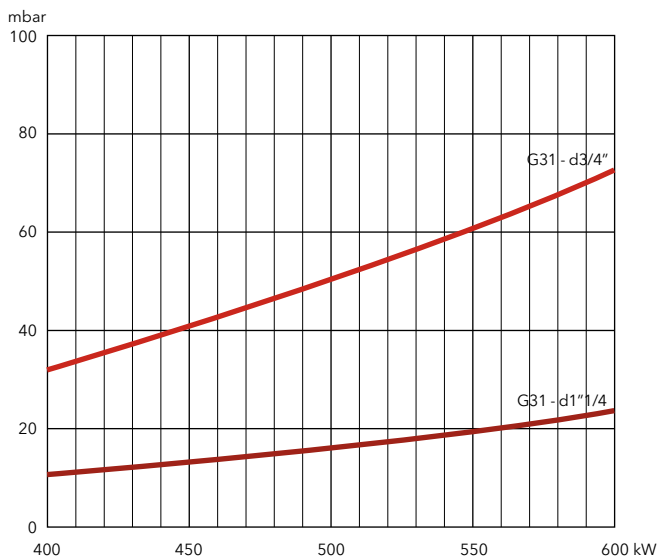

VG2.120 M E / VG2.160 M E / VG2.205 M E

40 ... 205 kW

Two stage progressive/modulating electronic

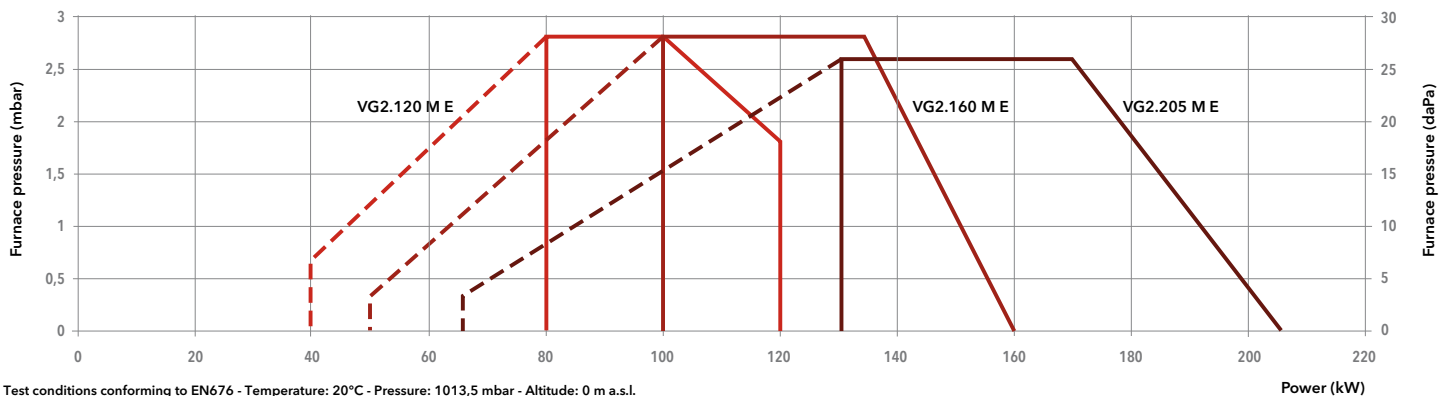

- **Fuels:** natural gas (G20/G25, $H_u = 8,83...10,35 \text{ kWh/m}^3$); LPG (G31, $H_u = 25,89 \text{ kWh/m}^3$)
- **Emissions:** $\text{NO}_x < 56 \text{ mg/kWh}$ (GCV), burners compliant with ErP Directive
- **Operation:** two stage progressive or modulating with the installation of a power regulator and dedicated probes (see page 198); integrated tightness control
- **Protection level:** IP 21

TECHNICAL DATA

| Model | VG2.120 M E /TC | | VG2.160 M E /TC | | VG2.205 M E /TC | | |
|---|------------------------|----------------|-----------------------|----------------|-----------------------|----------------|----------------|
| Operation range | (40) 80 - 120 kW | | (50) 100 - 160 kW | | (65) 130 - 205 kW | | |
| Gas pressure | 20 - 360 mbar | | 20 - 360 mbar | | 20 - 360 mbar | | |
| Control box / flame detection | BT3... / ionization | | BT3... / ionization | | BT3... / ionization | | |
| Fan motor | 230 V - 50 Hz - 100 W | | 230 V - 50 Hz - 100 W | | 230 V - 50 Hz - 130 W | | |
| Electrical consumption (min/max/stand-by) | 239 W / 358 W / 4 W | | 285 W / 293 W / 4 W | | 302 W / 267 W / 4 W | | |
| Acoustic level (LpA) | 62 dB(A) | | 64 dB(A) | | 65 dB(A) | | |
| CE certificate | 0476 CT 2423 | | 0476 CT 2423 | | 0476 CT 2423 | | |
| Head length | KN | KL | KN | KL | KN | KL | |
| Complete burner code | MBC300 d3/4"-Rp3/4"/TC | 3836480 | 3836481 | 3836482 | 3836483 | 3836484 | 3836485 |

OTHER AVAILABLE VERSIONS

 Versions for continuous ventilation and post-ventilation

SCOPE OF SUPPLY

The burner is delivered in its package complete with:

- 1 gas connection flange
- 1 compact gas train with gas filter; the gas filter is built-in for threaded valves (up to 2") and separated for flanged ones (DN65/80/100)
- 1 burner flange with insulation
- 1 bag containing installation fittings
- 1 bag containing technical documentation (instruction manual, technical data, electrical diagram, exploded view and spare parts list)



DIMENSIONS (mm)

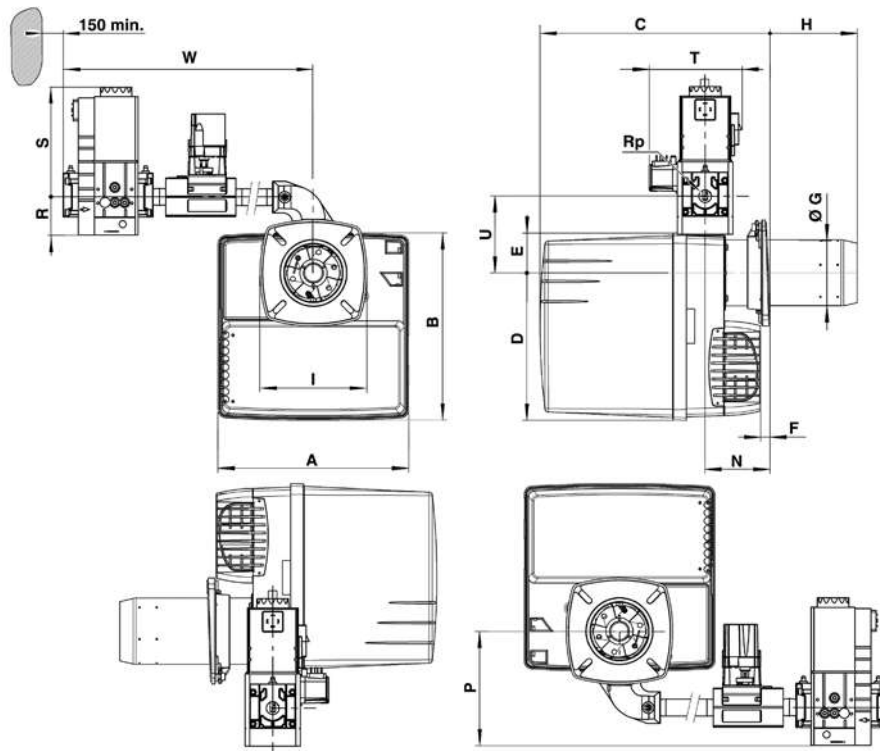

| Model | A | B | C | | D | E | F min | ØG | H | | I | N min | P | Rp | R | S | T | U | W |
|-------------|-----|-----|-----------|-----------|-----|----|-------|-----|----------|----------|-----|-------|-----|------|----|-----|-----|-----|-----|
| | | | KN | KL | | | | | KN | KL | | | | | | | | | |
| VG2.120/160 | 331 | 325 | 398...518 | 398...638 | 256 | 69 | 15 | 115 | 30...150 | 30...270 | 185 | 113 | 193 | 3/4" | 60 | 173 | 146 | 133 | 455 |
| VG2.205 | 331 | 325 | 398...518 | 398...638 | 256 | 69 | 15 | 125 | 30...150 | 30...270 | 185 | 113 | 193 | 3/4" | 60 | 173 | 146 | 133 | 455 |

Connecting flange

| Model | Øa (mm) | b (mm) | c | d |
|-------------|---------|---------|----|-----|
| VG2.120/160 | 120-135 | 150-185 | M8 | 45° |
| VG2.205 | 130-145 | 160-185 | M8 | 45° |

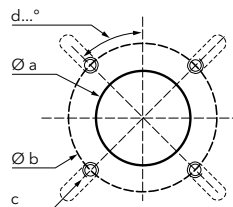

PACKAGING

The burner is delivered in two packages containing:

- burner housing and combustion head;
- gas train and filter.

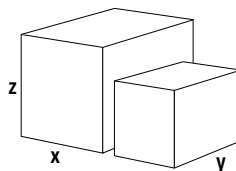

| Component | | Dimensions (mm) | | | Gross weight (kg) |
|-------------|-----------------|-----------------|-----|-----|-------------------|
| | | X | Y | Z | |
| Burner body | VG2.120 M E | 400 | 440 | 520 | 25 |
| | VG2.160 M E | 400 | 440 | 520 | 25 |
| | VG2.205 M E | 400 | 440 | 520 | 25 |
| Gas train | d3/4"-Rp3/4"/TC | 540 | 670 | 380 | 12 |

VG3.290 M E / VG3.350 M E

95 ... 350 kW

Two stage progressive/modulating electronic

- **Fuels:** natural gas (G20/G25, $H_u = 8,83...10,35 \text{ kWh/m}^3$); LPG (G31, $H_u = 25,89 \text{ kWh/m}^3$)
- **Emissions:** $\text{NO}_x < 56 \text{ mg/kWh}$ (GCV), burners compliant with ErP Directive
- **Operation:** two stage progressive or modulating with the installation of a power regulator and dedicated probes (see page 198), and integrated tightness control
- **Protection level:** IP 21



TECHNICAL DATA

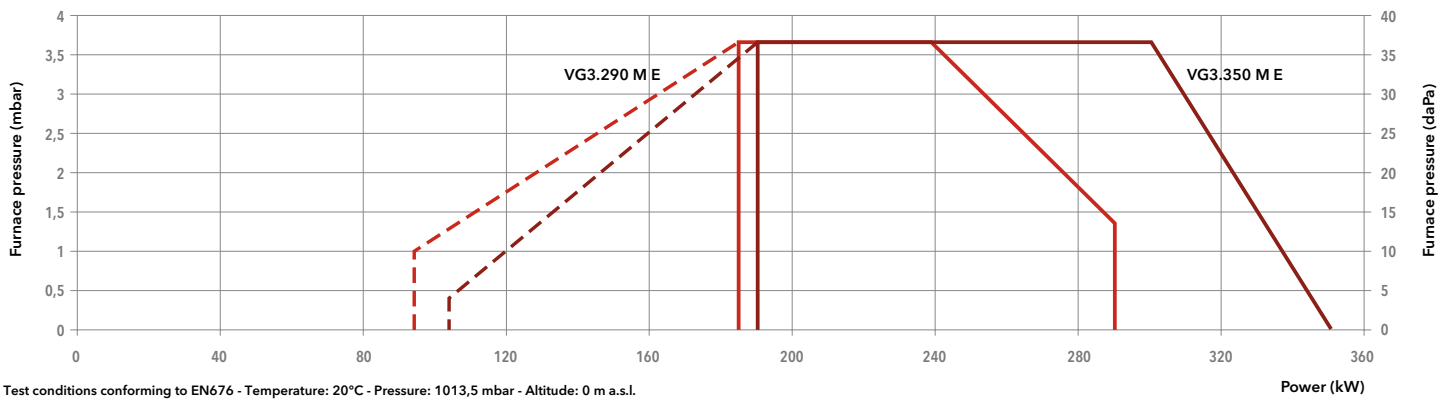

| Model | VG3.290 M E /TC | | VG3.350 M E /TC | |
|---|---|--------------|-----------------------|--------------------|
| Operation range | (95) 185 - 290 kW | | (105) 190 - 350 kW | |
| Gas pressure | 20 - 360 mbar | | 20 - 360 mbar | |
| Control box / flame detection | BT3... / ionization | | BT3... / ionization | |
| Fan motor | 230 V - 50 Hz - 250 W | | 230 V - 50 Hz - 300 W | |
| Electrical consumption (max/min/stand-by) | 465 W / 441 W / 4 W | | 583 W / 583 W / 4 W | |
| Acoustic level (LpA) | 67 dB(A) | | 69 dB(A) | |
| CE certificate | 0476 CT 2423 | | 0476 CT 2423 | |
| Head length | KN | KL | KN | KL |
| Complete burner code | MBC700 d1"1/2-Rp1"1/2/TC MBC300 d3/4"-Rp1"1/4/TC | - 3836486 | - 3836487 | 3836488 3836490 |
| | | | | 3836489 3836491 |

OTHER AVAILABLE VERSIONS

Versions for continuous ventilation and post-ventilation

SCOPE OF SUPPLY

The burner is delivered in its package complete with:

- 1 burner head with flange seal and securing screws
- 1 compact gas train with gas filter; the gas filter is built-in for threaded valves (up to 2") and separated for flanged ones (DN65/80/100)
- 1 bag containing installation fittings
- 1 bag containing technical documentation (instruction manual, technical data, electrical diagram, exploded view and spare parts list)



DIMENSIONS (mm)

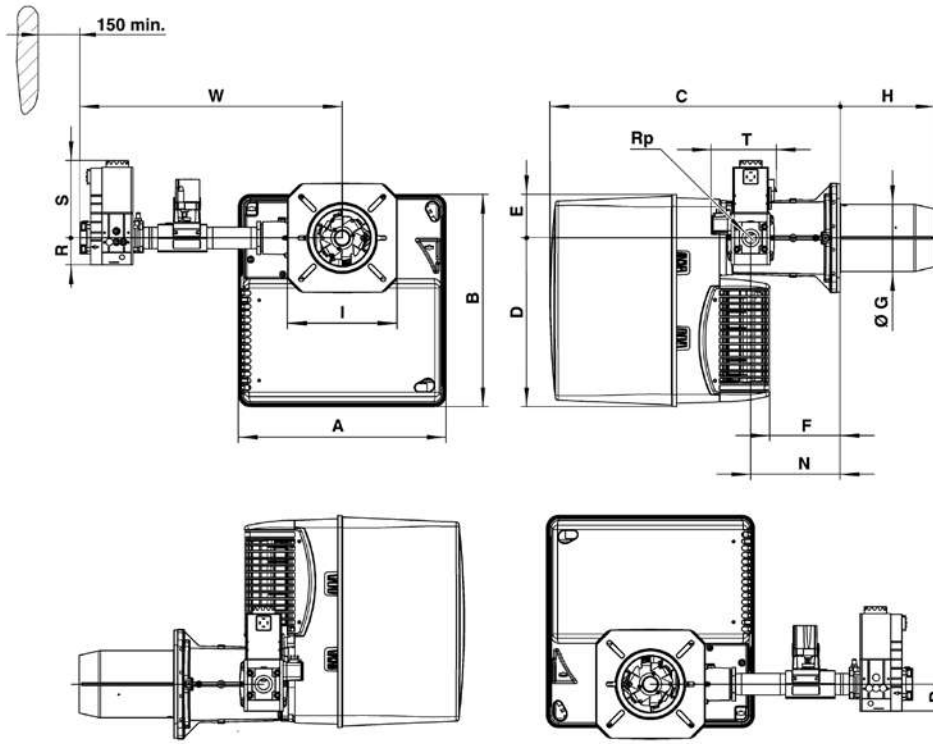

| Gas train model | A | B | C | D | E | F | ØG | H | | I | N | Rp | R | S | T | W |
|-------------------|-----|-----|-----|-----|----|-----|-----|-----|-----|---------|-----|-------|----|-----|-----|-----|
| | | | | | | | | KN | KL | | | | | | | |
| d1"1/2-Rp1"1/2/TC | 406 | 379 | 576 | 297 | 82 | 120 | 130 | 180 | 320 | 195x205 | 170 | 1"1/2 | 80 | 185 | 160 | 638 |
| d3/4"-Rp1"1/4/TC | 406 | 379 | 576 | 297 | 82 | 120 | 130 | 180 | 320 | 195x205 | 170 | 1"1/4 | 60 | 173 | 146 | 577 |

Connecting flange

| Øa (mm) | b (mm) | c | d |
|---------|---------|-----|-----|
| 155-190 | 175-220 | M10 | 45° |

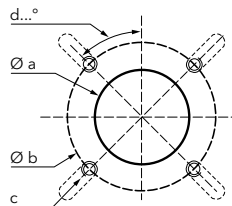

PACKAGING

The burner is delivered on a pallet in three packages containing:

- burner housing
- combustion head
- gas train and filter

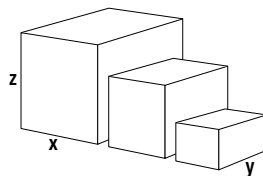

| Component | | Dimensions (mm) | | | Gross weight (kg) |
|-----------------|-------------------|-----------------|-----|-----|-------------------|
| | | X | Y | Z | |
| Burner body | VG3.290 M E | 440 | 400 | 520 | 21 |
| | VG3.350 M E | 440 | 400 | 520 | 22 |
| Combustion head | KN | 650 | 210 | 260 | 6 |
| | KL | 780 | 210 | 260 | 7 |
| Gas train | d1"1/2-Rp1"1/2/TC | 670 | 540 | 380 | 12 |
| | d3/4"-Rp1"1/4/TC | 670 | 540 | 380 | 12 |

VG3.290 M E / VG3.350 M E

95 ... 350 kW

Two stage progressive/modulating electronic

PRESSURE LOSS [BURNER HEAD + GAS TRAIN] (mbar)

VG3.290 M E

| Burner output (kW) | Natural gas G20 Hi = 10,35 kWh/m ³ | Natural gas G25 Hi = 8,83 kWh/m ³ | LPG G31 Hi = 25,89 kWh/m ³ |
|--------------------|---|--|---------------------------------------|
| | d3/4"-Rp1"1/4 | d3/4"-Rp1"1/4 | d3/4"-Rp1"1/4 |
| 190 | 12 | 14 | 10 |
| 210 | 12 | 15 | 10 |
| 230 | 13 | 16 | 10 |
| 250 | 14 | 18 | 10 |
| 270 | 16 | 20 | 11 |
| 290 | 18 | 23 | 12 |

Natural gas G20

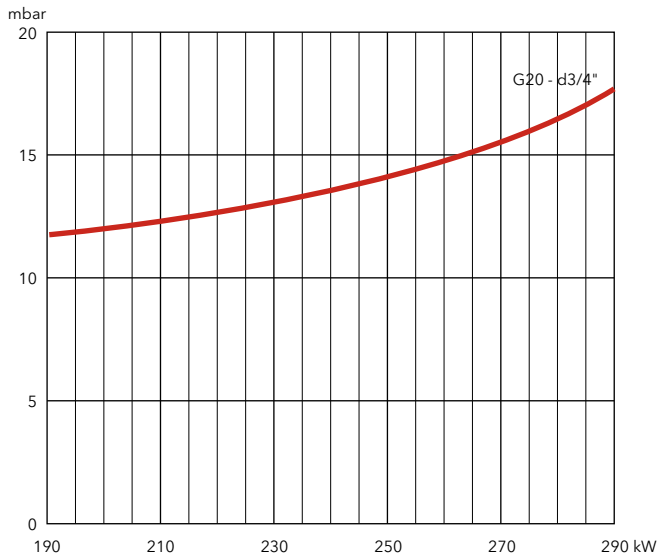

Natural gas G25

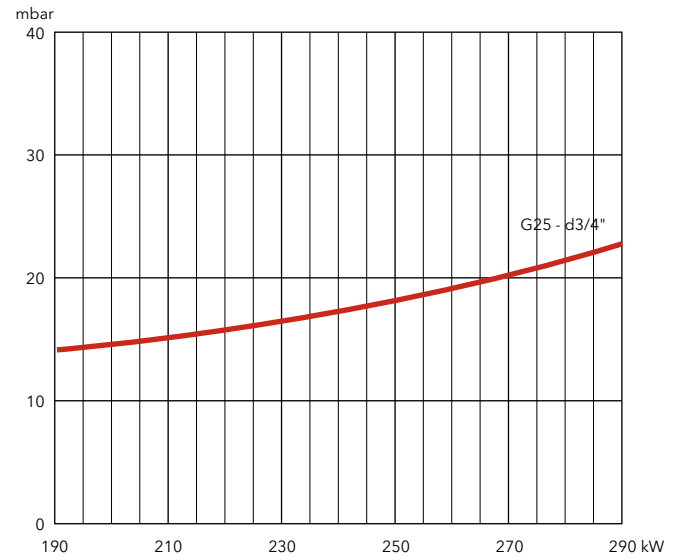

LPG

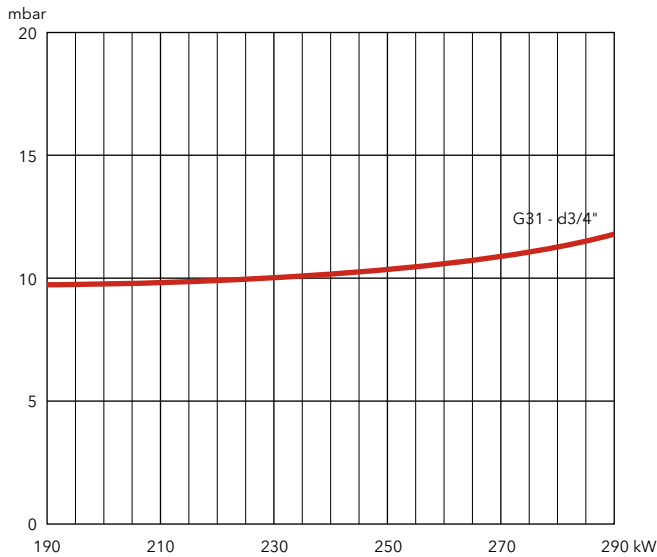



PRESSURE LOSS [BURNER HEAD + GAS TRAIN] (mbar)

VG3.350 M E

| Burner output (kW) | Natural gas G20 Hi = 10,35 kWh/m ³ | | Natural gas G25 Hi = 8,83 kWh/m ³ | | LPG G31 Hi = 25,89 kWh/m ³ | |
|--------------------|---|----------------|--|----------------|---------------------------------------|----------------|
| | d3/4"-Rp1"1/4 | d1"1/2-Rp1"1/2 | d3/4"-Rp1"1/4 | d1"1/2-Rp1"1/2 | d3/4"-Rp1"1/4 | d1"1/2-Rp1"1/2 |
| 190 | 9 | 5 | 11 | 5 | 7 | 6 |
| 230 | 10 | 6 | 15 | 6 | 8 | 7 |
| 270 | 12 | 7 | 19 | 7 | 11 | 8 |
| 310 | 15 | 9 | 25 | 9 | 13 | 10 |
| 350 | 20 | 11 | 32 | 12 | 16 | 12 |

Natural gas G20

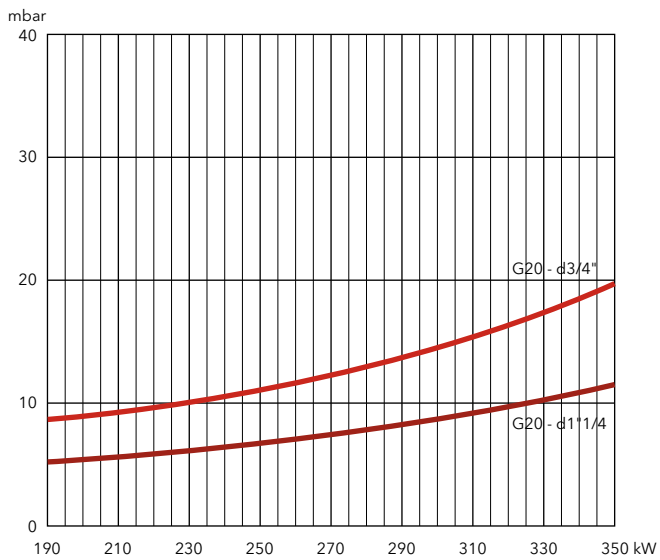

Natural gas G25

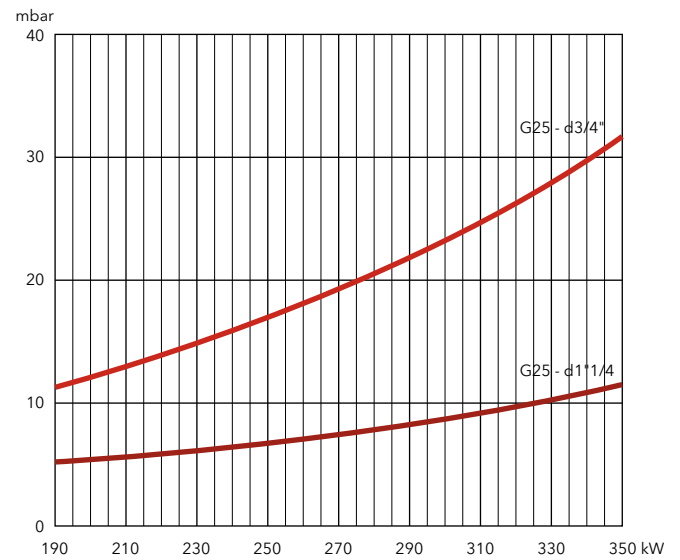

LPG

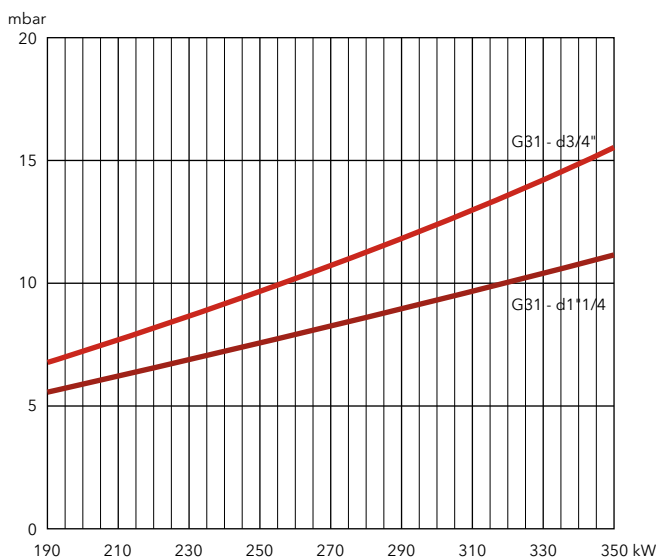

VG4.440 M E

110 ... 440 kW

Two stage progressive/modulating electronic

- **Fuels:** natural gas (G20/G25, $H_u = 8,83...10,35 \text{ kWh/m}^3$);
LPG (G31, $H_u = 25,89 \text{ kWh/m}^3$)
- **Emissions:** $\text{NO}_x < 56 \text{ mg/kWh}$ (GCV), burners compliant with ErP Directive
- **Operation:** two stage progressive or modulating with the installation of a power regulator and dedicated probes (see page 198), and integrated tightness control
- **Protection level:** IP 21

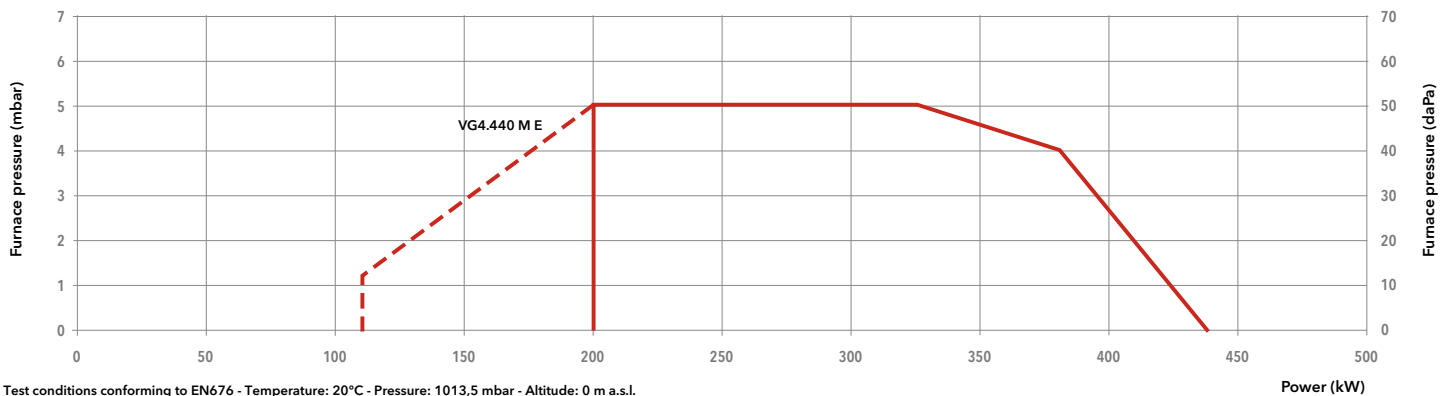
**TECHNICAL DATA**

| | | | |
|--|--------------------------|----------------|----------------|
| Model | VG4.440 M E /TC | | |
| Operation range | (110) 200 - 440 | | |
| Gas pressure | 20 - 360 mbar | | |
| Control box / flame detection | BT3... / ionization | | |
| Fan motor | 230 V - 50 Hz - 420 W | | |
| Electrical consumption (max/min/stand-by) | 606 W / 569 W / 4 W | | |
| Acoustic level (LpA) | 70 dB(A) | | |
| CE certificate | 0476 CT 2423 | | |
| Head length | KN | | KL |
| Complete burner code | MBC700 d1"1/2-Rp1"1/2/TC | 3836492 | 3836493 |
| | MBC300 d3/4"-Rp1"1/4/TC | 3836494 | 3836495 |

OTHER AVAILABLE VERSIONS

 Versions for continuous ventilation and post-ventilation

SCOPE OF SUPPLY

The burner is delivered in its package complete with:

- 1 burner head with flange seal and securing screws
- 1 compact gas train with gas filter; the gas filter is built-in for threaded valves (up to 2") and separated for flanged ones (DN65/80/100)
- 1 bag containing installation fittings
- 1 bag containing technical documentation (instruction manual, technical data, electrical diagram, exploded view and spare parts list)



DIMENSIONS (mm)

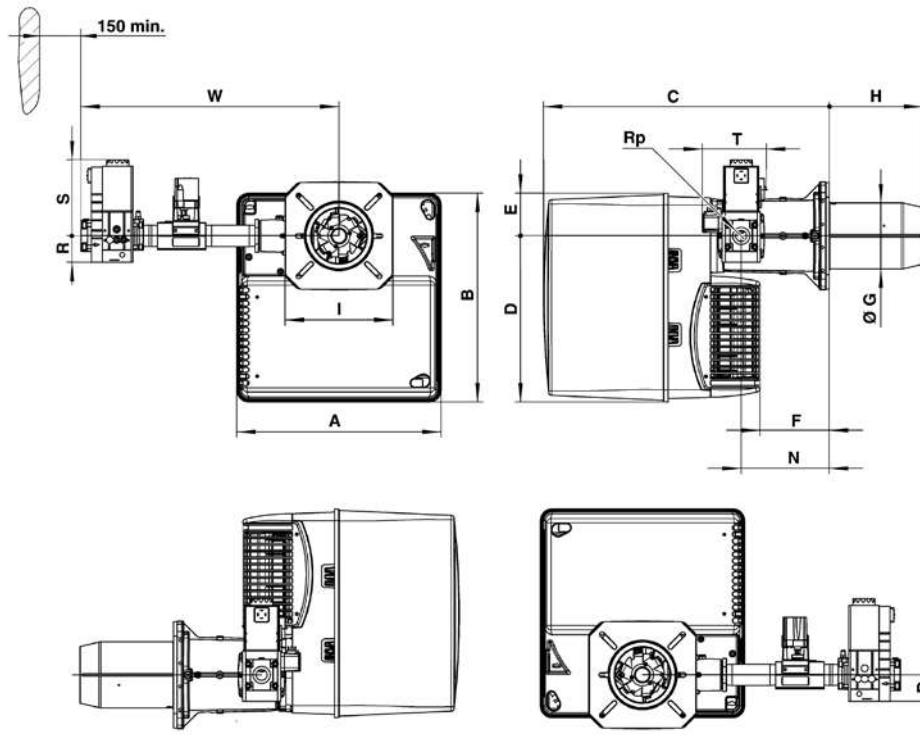

| Gas train model | A | B | C | D | E | F | ØG | H | | I | N | Rp | R | S | T | W |
|-------------------|-----|-----|-----|-----|----|-----|-----|-----|-----|-----|-----|-------|----|-----|-----|-----|
| | | | | | | | | KN | KL | | | | | | | |
| d1"1/2-Rp1"1/2/TC | 465 | 475 | 640 | 377 | 97 | 149 | 157 | 212 | 352 | 245 | 195 | 1"1/2 | 80 | 185 | 160 | 649 |
| d3/4"-Rp1"1/4/TC | 465 | 475 | 640 | 377 | 97 | 149 | 157 | 212 | 352 | 245 | 195 | 1"1/4 | 60 | 173 | 146 | 587 |

Connecting flange

| Øa (mm) | b (mm) | c | d |
|---------|---------|-----|-----|
| 190-240 | 200-270 | M10 | 45° |

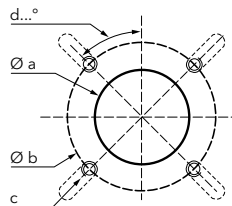

PACKAGING

The burner is delivered on a pallet in three packages containing:

- burner housing
- combustion head
- gas train and filter

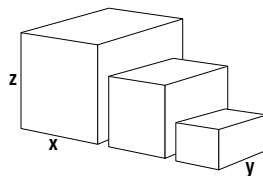

| Component | Component | Dimensions (mm) | | | Gross weight (kg) |
|-----------------|-------------------|-----------------|-----|-----|-------------------|
| | | X | Y | Z | |
| Burner body | VG4.440 M E | 490 | 490 | 590 | 28,6 |
| Combustion head | KN | 750 | 260 | 295 | 8,9 |
| | KL | 895 | 260 | 295 | 10,1 |
| Gas train | d1"1/2-Rp1"1/2/TC | 670 | 540 | 380 | 12 |
| | d3/4"-Rp1"1/4/TC | 670 | 540 | 380 | 12 |

VG4.440 M E

110 ... 440 kW

Two stage progressive/modulating electronic

PRESSURE LOSS [BURNER HEAD + GAS TRAIN] (mbar)

VG4.440 M E

| Burner output (kW) | Natural gas G20 Hi = 10,35 kWh/m ³ | | Natural gas G25 Hi = 8,83 kWh/m ³ | |
|--------------------|---|----------------|--|----------------|
| | d3/4"-Rp1"1/4 | d1"1/2-Rp1"1/2 | d3/4"-Rp1"1/4 | d1"1/2-Rp1"1/2 |
| 240 | 11 | 7 | 15 | 9 |
| 280 | 13 | 8 | 18 | 10 |
| 320 | 16 | 9 | 22 | 12 |
| 360 | 19 | 10 | 28 | 14 |
| 400 | 23 | 12 | 34 | 17 |
| 440 | 28 | 14 | 41 | 20 |

Natural gas G20

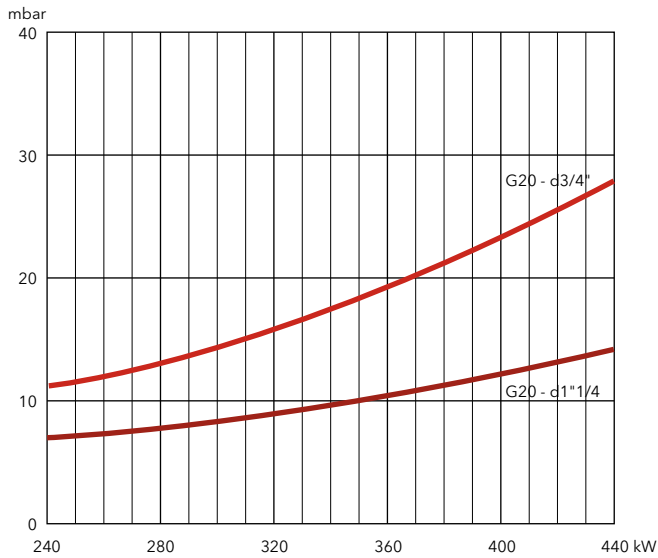

Natural gas G25

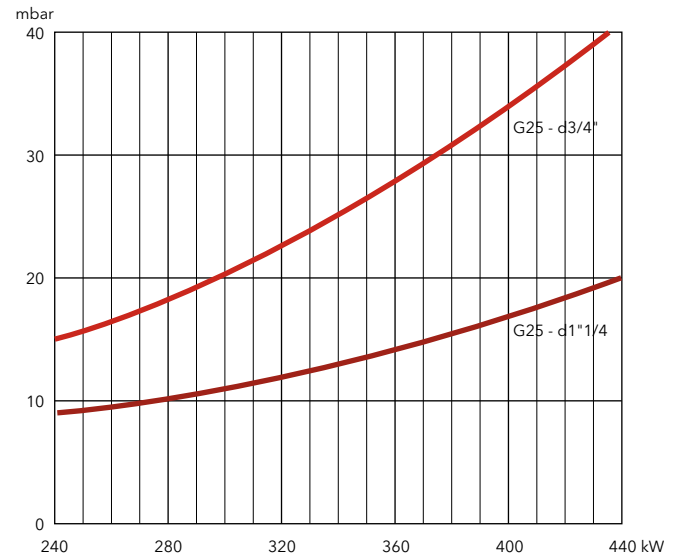



PRESSURE LOSS [BURNER HEAD + GAS TRAIN] (mbar)

VG4.440 M E

| Burner output (kW) | LPG G31 Hi = 25,89 kWh/m ³ | |
|--------------------|---------------------------------------|----------------|
| | d3/4"-Rp1"1/4 | d1"1/2-Rp1"1/2 |
| 240 | 10 | 8 |
| 280 | 11 | 9 |
| 320 | 13 | 9 |
| 360 | 15 | 11 |
| 400 | 17 | 13 |
| 440 | 20 | 15 |

LPG

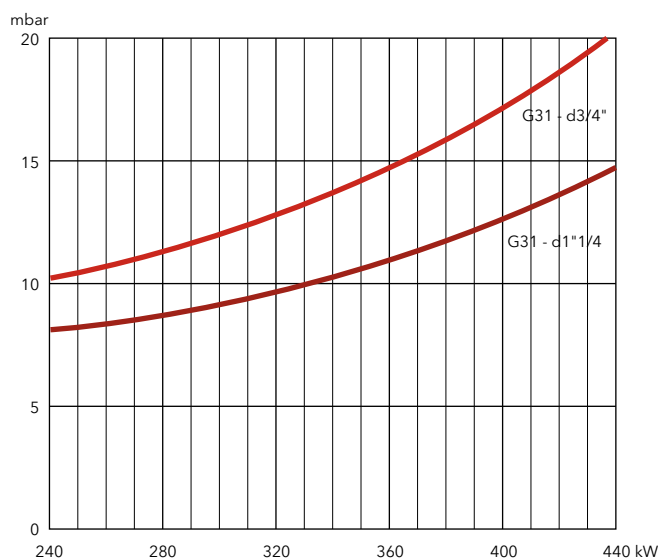

VG4.460 M / VG4.610 M

86 ... 610 kW

Two stage progressive/modulating electronic

- **Fuels:** natural gas, net calorific value 8,83...10,35 kWh/m³;
LPG, net calorific value 25,89 kWh/m³
- **Emissions:** NOx < 70 mg/kWh (NCV), Low NOx class 3 burners according to EN676
- **Operation:** two stage progressive or modulating with the installation of a power regulator and dedicated probes (see page 198), and integrated tightness control
- **Protection level:** IP 41



TECHNICAL DATA

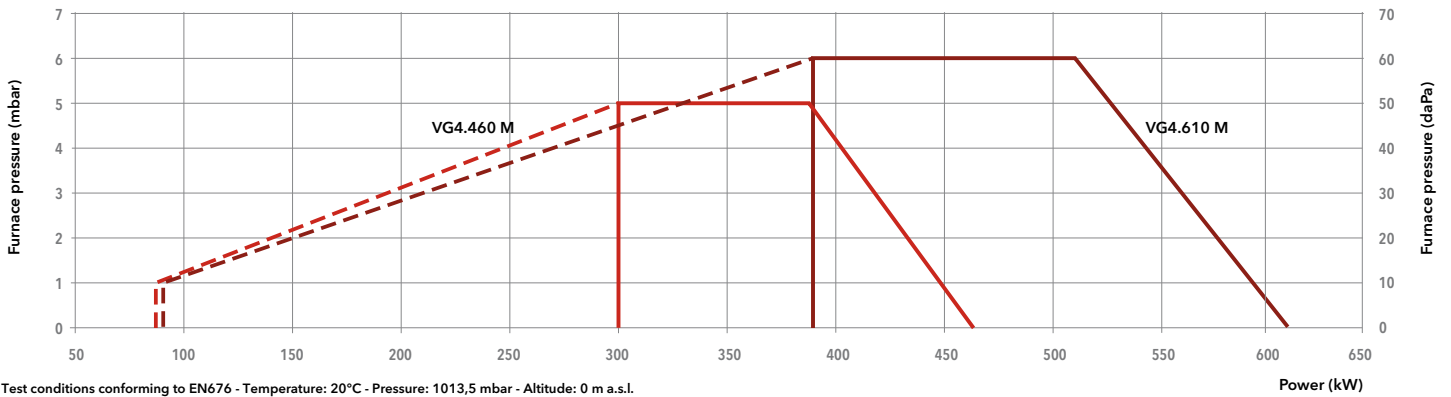

| Model | VG 4.460 M /TC | | VG 4.610 M /TC | |
|-------------------------------|---|--------------------|-----------------------|--------------------|
| Operation range | (86) 300 - 460 | | (90) 390 - 610 kW | |
| Gas pressure | 20 - 300 mbar | | 20 - 300 mbar | |
| Control box / flame detection | BT3... / ionization | | BT3... / ionization | |
| Fan motor | 230 V - 50 Hz - 420 W | | 230 V - 50 Hz - 750 W | |
| Electrical consumption | 510 W | | 760 W | |
| Acoustic level (LpA) | 70 dB(A) | | 71 dB(A) | |
| CE certificate | 0085 CN 0192 | | 0085 CN 0192 | |
| Head length | KN | KL | KN | KL |
| Complete burner code | MBC700 d1"1/2-Rp1"1/2/TC MBC300 d3/4"-Rp1"1/4/TC | 3833782 3833780 | 3833783 3833781 | 3833786 3833784 |
| | | | | 3833787 3833785 |

OTHER AVAILABLE VERSIONS

Versions for continuous ventilation and post-ventilation

SCOPE OF SUPPLY

- The burner is delivered in its package complete with:
- 1 burner head with flange seal and securing screws
 - 1 compact gas train with gas filter
 - 1 bag containing installation fittings
 - 1 bag containing technical documentation (instruction manual, technical data, electrical diagram, exploded view and spare parts list)



DIMENSIONS (mm)

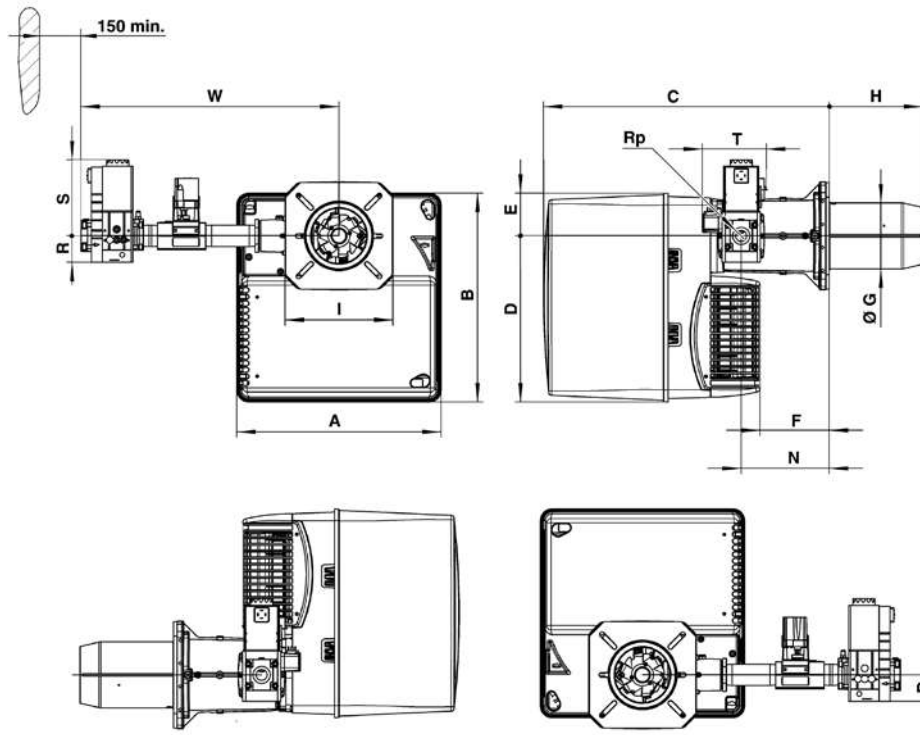

| Gas train model | A | B | C | D | E | F | ØG | H | | I | N | Rp | R | S | T | W |
|-------------------|-----|-----|-----|-----|----|-----|-----|-----|-----|-----|-----|-------|----|-----|-----|-----|
| | | | | | | | | KN | KL | | | | | | | |
| d1"1/2-Rp1"1/2/TC | 465 | 475 | 640 | 377 | 97 | 149 | 150 | 220 | 360 | 245 | 195 | 1"1/2 | 80 | 185 | 160 | 649 |
| d3/4"-Rp1"1/4/TC | 465 | 475 | 640 | 377 | 97 | 149 | 150 | 220 | 360 | 245 | 195 | 1"1/4 | 60 | 173 | 146 | 587 |

Connecting flange

| Øa (mm) | b (mm) | c | d |
|---------|---------|-----|-----|
| 180-240 | 200-270 | M10 | 45° |

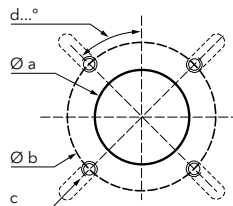

PACKAGING

The burner is delivered on a pallet in three packages containing:

- burner housing
- combustion head
- gas train and filter

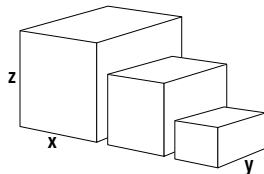

| Component | | Dimensions (mm) | | | Gross weight (kg) |
|-----------------|-------------------|-----------------|-----|-----|-------------------|
| | | X | Y | Z | |
| Burner body | VG 4.460 M | 490 | 490 | 590 | 28,6 |
| | VG 4.610 M | 490 | 490 | 590 | 32,7 |
| Combustion head | KN | 750 | 260 | 295 | 8,9 |
| | KL | 895 | 260 | 295 | 10,1 |
| Gas train | d1"1/2-Rp1"1/2/TC | 670 | 540 | 380 | 12 |
| | d3/4"-Rp1"1/4/TC | 670 | 540 | 380 | 12 |

VG4.460 M / VG4.610 M

86 ... 610 kW

Two stage progressive/modulating electronic

PRESSURE LOSS [BURNER HEAD + GAS TRAIN] (mbar)

VG 4.460 M

| Burner output (kW) | Natural gas G20 Hi = 10,35 kWh/m ³ | | Natural gas G25 Hi = 8,83 kWh/m ³ | | LPG G31 Hi = 25,89 kWh/m ³ |
|--------------------|---|----------------|--|----------------|---------------------------------------|
| | d3/4"-Rp1"1/4 | d1"1/2-Rp1"1/2 | d3/4"-Rp1"1/4 | d1"1/2-Rp1"1/2 | d3/4"-Rp1"1/4 |
| 300 | 15 | 6 | 20 | 8 | 10 |
| 350 | 19 | 7 | 27 | 10 | 13 |
| 400 | 24 | 8 | 34 | 12 | 16 |
| 450 | 30 | 10 | 43 | 15 | 19 |

Natural gas G20

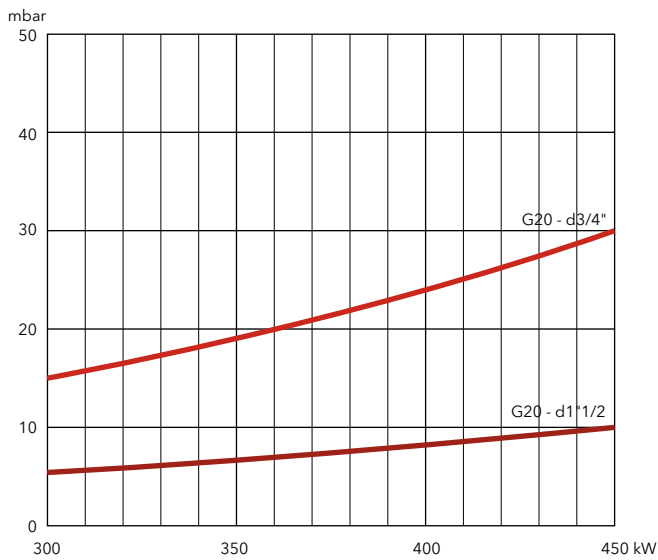

Natural gas G25

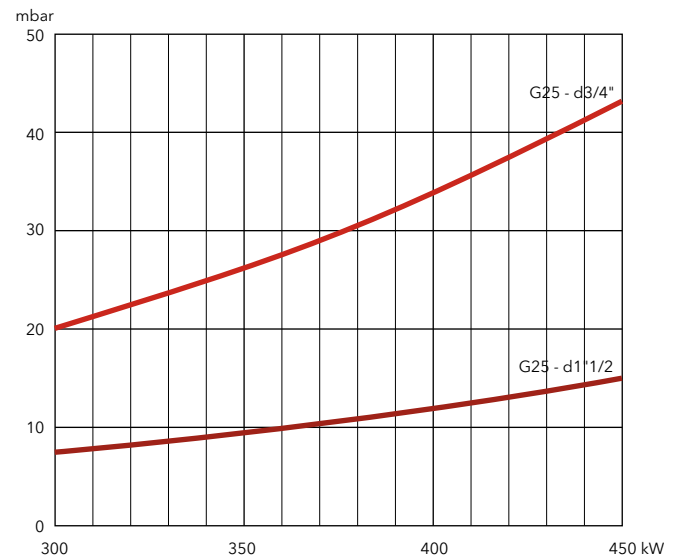

LPG

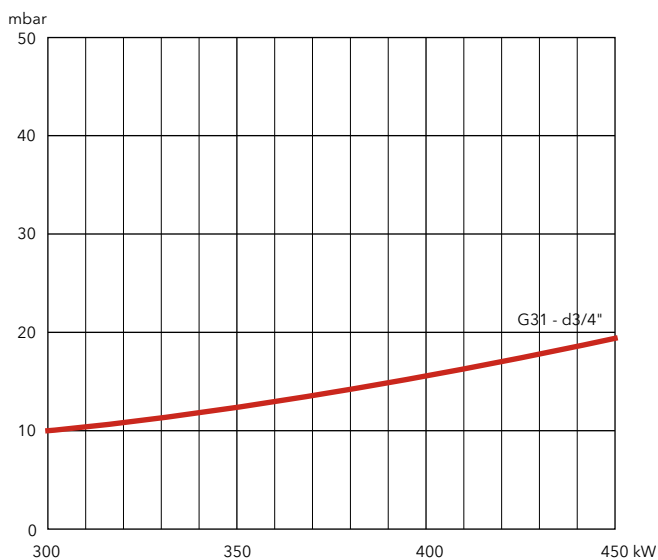



PRESSURE LOSS [BURNER HEAD + GAS TRAIN] (mbar)

VG 4.610 M

| Burner output (kW) | Natural gas G20 Hi = 10,35 kWh/m ³ | | Natural gas G25 Hi = 8,83 kWh/m ³ | | LPG G31 Hi = 25,89 kWh/m ³ |
|--------------------|---|----------------|--|----------------|---------------------------------------|
| | d3/4"-Rp1"1/4 | d1"1/2-Rp1"1/2 | d3/4"-Rp1"1/4 | d1"1/2-Rp1"1/2 | d3/4"-Rp1"1/4 |
| 400 | 23 | 8 | 32 | 10 | 13 |
| 450 | 29 | 10 | 40 | 12 | 15 |
| 500 | 35 | 12 | 50 | 15 | 18 |
| 550 | 42 | 14 | 61 | 18 | 21 |
| 600 | 50 | 16 | 73 | 22 | 25 |

Natural gas G20

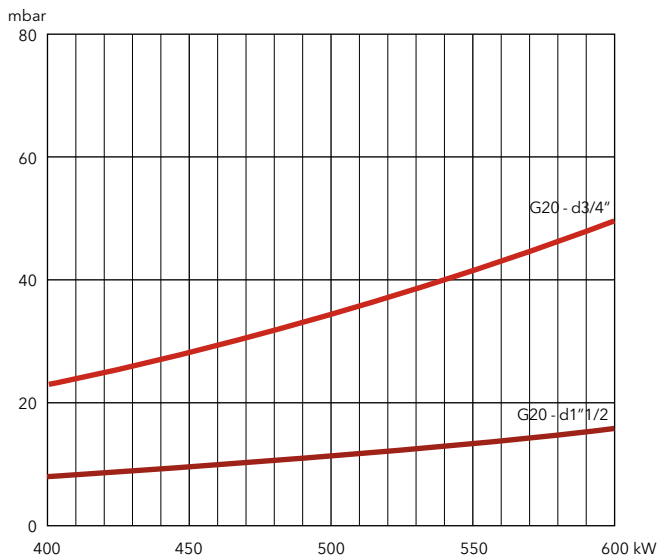

Natural gas G25

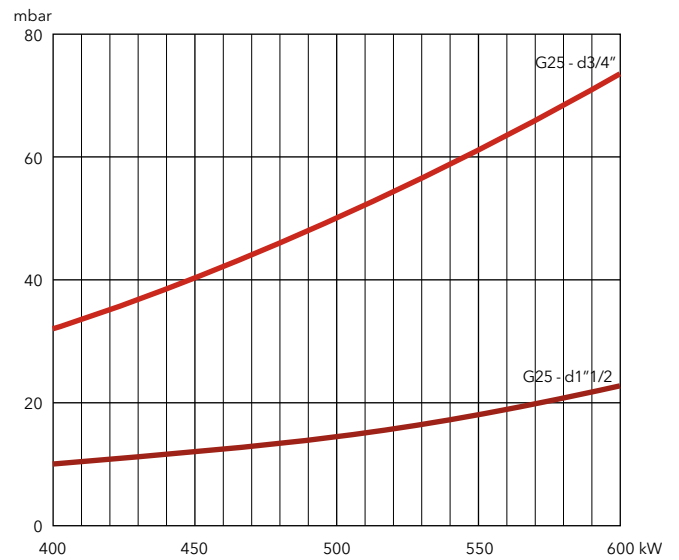

LPG

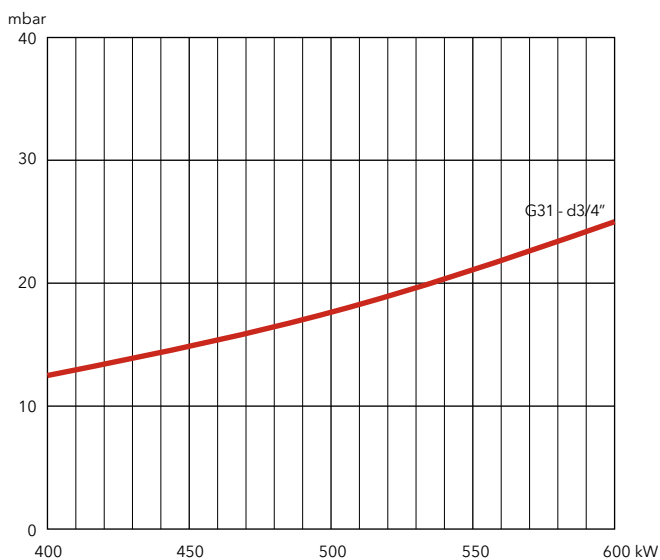

VG5.950 M / VG5.1200 M

160 ... 1160 kW

Two stage progressive/modulating electronic

- **Fuels:** natural gas (G20/G25, $H_u = 8,83...10,35 \text{ kWh/m}^3$); LPG (G31, $H_u = 25,89 \text{ kWh/m}^3$)
- **Emissions:** NOx < 70 mg/kWh (NCV), Low NOx class 3 burners according to EN676
- **Operation:** two stage progressive or modulating with the installation of a power regulator and dedicated probes (see page 198), and integrated tightness control
- **Protection level:** IP 21



TECHNICAL DATA

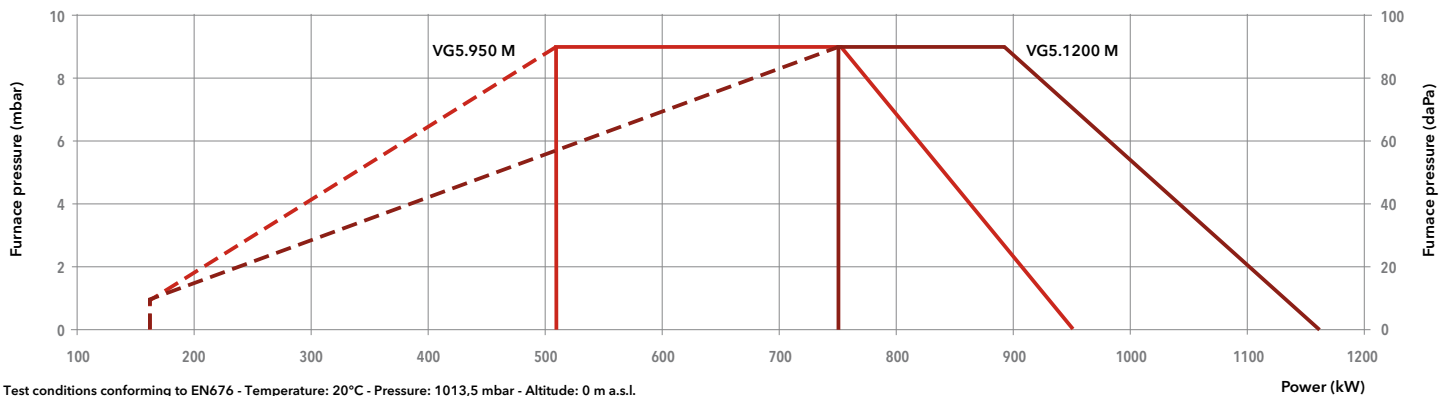

Test conditions conforming to EN676 - Temperature: 20°C - Pressure: 1013,5 mbar - Altitude: 0 m a.s.l.

| Model | VG5.950 M /TC | | | VG5.1200 M /TC | | | | |
|-------------------------------|----------------------------|------------------|---------|----------------------------|---------|---------|---------|---------|
| Operation range | (160)510 – 950 kW | | | (160)750 – 1160 kW | | | | |
| Gas pressure | 20 – 300 mbar | | | 20 – 300 mbar | | | | |
| Control box / flame detection | BT3... / ionization | | | BT3... / ionization | | | | |
| Fan motor | 230/400 V – 50 Hz – 1,5 kW | | | 230/400 V – 50 Hz – 1,5 kW | | | | |
| Electrical consumption | 55 + 1750 W | | | 55 + 2100 W | | | | |
| Acoustic level (LpA) | 77 dB(A) | | | 77 dB(A) | | | | |
| CE certificate | 0085 CN 0192 | | | 0085 CN 0192 | | | | |
| Head length | | KN | KL | KM | KN | KL | KM | |
| Complete burner code | VGD40-065 | s65-DN65/TC | 3833999 | 3834000 | 3834001 | 3834005 | 3834006 | 3834007 |
| | MBC1900 | d65-DN65/TC | 3833996 | 3833997 | 3833998 | 3834002 | 3834003 | 3834004 |
| | MBC1200 | d2"-Rp2"/TC | 3833803 | 3833804 | 3833805 | 3833809 | 3833810 | 3833811 |
| | MBC700 | d1"1/2-Rp2"/TC | 3833800 | 3833801 | 3833802 | 3833806 | 3833807 | 3833808 |
| | MBC300 | d3/4"-Rp1"1/4/TC | 3834099 | 3834100 | 3834101 | 3834102 | 3834103 | 3834104 |

OTHER AVAILABLE VERSIONS

- Vent** Versions for continuous ventilation and post-ventilation
- PED** PED version for continuous operation

SCOPE OF SUPPLY

The burner is delivered in its package complete with:

- 1 burner head with flange seal and securing screws
- 1 compact gas train with gas filter; the gas filter is built-in for threaded valves (up to 2") and separated for flanged ones (DN65/80/100)
- 1 bag containing installation fittings
- 1 bag containing technical documentation (instruction manual, technical data, electrical diagram, exploded view and spare parts list)



DIMENSIONS (mm)

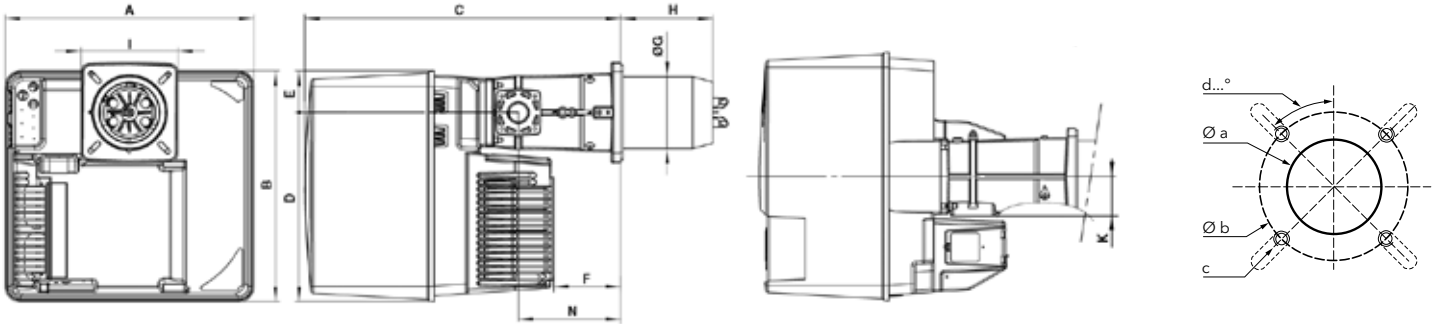

| A | B | C | D | E | F | ØG | H | | | I | K | N |
|-----|-----|-----|-----|----|-----|-----|-----|-----|-----|---------|----|-----|
| | | | | | | | KN | KM | KL | | | |
| 581 | 549 | 752 | 450 | 99 | 164 | 170 | 215 | 325 | 435 | 230x238 | 89 | 244 |

| Øa (mm) | b (mm) | c | d |
|---------|---------|-----|-----|
| 195 | 220-260 | M10 | 45° |

Gas trains

Gas train "d":

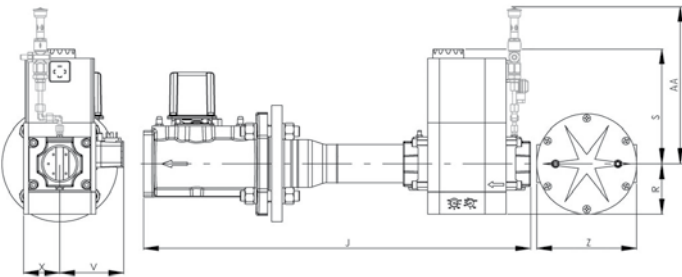

| Model | J | R | S | V | X | Z | AA* |
|---------------|-----|-----|-----|-----|----|-----|-----|
| d65-DN65 | 490 | 183 | 245 | 110 | 98 | 290 | 385 |
| d2"-Rp2" | 700 | 96 | 330 | 125 | 81 | - | 385 |
| d1"1/2-Rp2" | 622 | 80 | 185 | 102 | 57 | - | 320 |
| d3/4"-Rp1"1/4 | 460 | 60 | 173 | 88 | 58 | - | 320 |

Gas train "s":

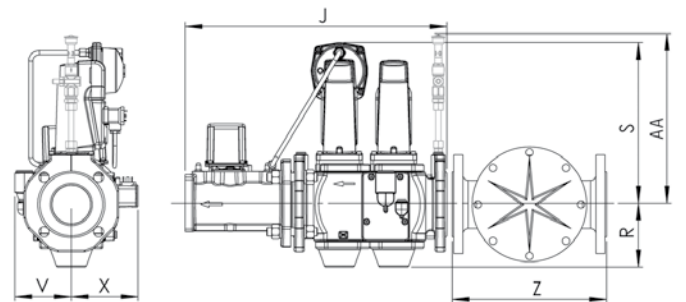

| Model | J | R | S | V | X | Z | AA* |
|----------|-----|-----|-----|-----|-----|-----|-----|
| s65-DN65 | 490 | 118 | 300 | 106 | 126 | 290 | 365 |

*: for PED configuration

PACKAGING

The burner is delivered on a pallet in three packages containing:

- burner housing
- combustion head
- gas train and filter

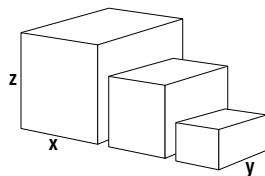

| Component | | Dimensions (mm) | | | Gross weight (kg) |
|-----------------|------------------|-----------------|-----|-----|-------------------|
| | | X | Y | Z | |
| Burner body | VG5.950 M | 800 | 600 | 850 | 56 |
| | VG5.1200 M | 800 | 600 | 850 | 56 |
| Combustion head | KN | 780 | 265 | 280 | 12,3 |
| | KL | 1010 | 265 | 280 | 14,4 |
| | KM | 1010 | 265 | 280 | 13,4 |
| Gas train | s65-DN65/TC | 670 | 550 | 380 | 29 |
| | d65-DN65/TC | 670 | 550 | 380 | 33 |
| | d2"-Rp2"/TC | 670 | 550 | 380 | 22 |
| | d1"1/2-Rp2"/TC | 670 | 550 | 380 | 21 |
| | d3/4"-Rp1"1/4/TC | 670 | 550 | 380 | 12 |

VG5.950 M / VG5.1200 M

160 ... 1160 kW

Two stage progressive/modulating electronic

PRESSURE LOSS [BURNER HEAD + GAS TRAIN] (mbar)

VG5.950 M

| Burner output (kW) | Natural gas G20 Hi = 10,35 kWh/m ³ | | | | | Natural gas G25 Hi = 8,83 kWh/m ³ | | | | | LPG G31 |
|--------------------|---|-------------|----------|----------|----------|--|-------------|----------|----------|----------|-------------|
| | d3/4-Rp1"1/4 | d1"1/2-Rp2" | d2"-Rp2" | d65-DN65 | s65-DN65 | d3/4-Rp1"1/4 | d1"1/2-Rp2" | d2"-Rp2" | d65-DN65 | s65-DN65 | d1"1/2-Rp2" |
| 500 | 31 | 9 | 8 | 5 | 5 | 37 | 11 | 9 | 5 | 6 | 6 |
| 600 | 43 | 13 | 10 | 8 | 8 | 53 | 16 | 12 | 7 | 9 | 8 |
| 700 | 58 | 17 | 13 | 10 | 10 | 73 | 21 | 15 | 10 | 12 | 10 |
| 800 | 76 | 22 | 16 | 13 | 13 | 96 | 28 | 19 | 13 | 16 | 13 |
| 900 | 97 | 27 | 19 | 17 | 17 | 124 | 35 | 23 | 17 | 20 | 16 |

Natural gas G20

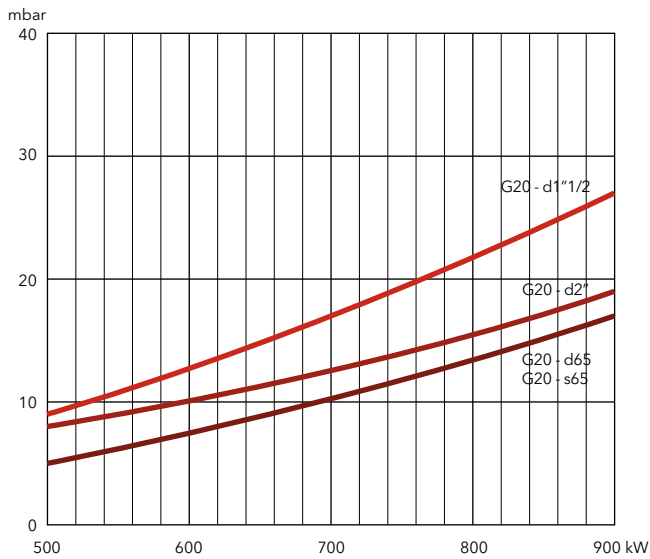

Natural gas G25

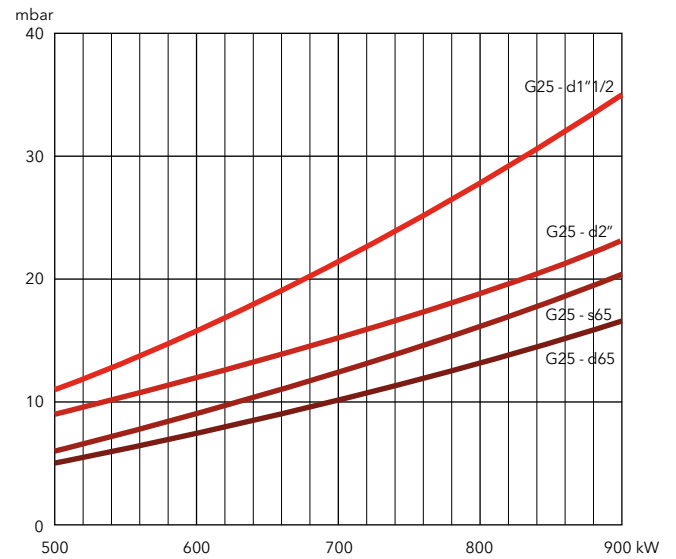

Natural gas G20, G25

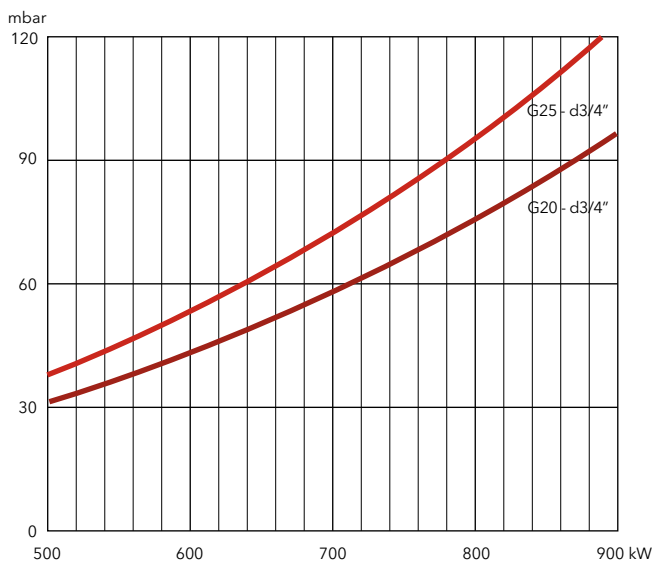

LPG

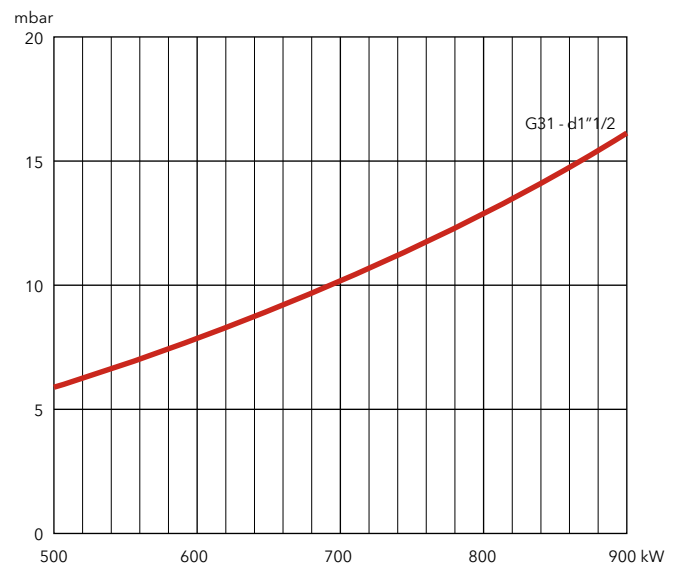



PRESSURE LOSS [BURNER HEAD + GAS TRAIN] (mbar)

VG5.1200 M

| Burner output (kW) | Natural gas G20 Hi = 10,35 kWh/m ³ | | | | | Natural gas G25 Hi = 8,83 kWh/m ³ | | | | | LPG G31 |
|--------------------|---|-------------|----------|----------|----------|--|-------------|----------|----------|----------|-------------|
| | d3/4-Rp1"1/4 | d1"1/2-Rp2" | d2"-Rp2" | d65-DN65 | s65-DN65 | d3/4-Rp1"1/4 | d1"1/2-Rp2" | d2"-Rp2" | d65-DN65 | s65-DN65 | d1"1/2-Rp2" |
| 700 | 40 | 16 | 12 | 10 | 10 | 60 | 21 | 14 | 10 | 12 | 10 |
| 800 | 53 | 20 | 14 | 13 | 13 | 79 | 27 | 17 | 13 | 15 | 12 |
| 900 | 68 | 25 | 17 | 16 | 16 | 100 | 34 | 21 | 16 | 19 | 15 |
| 1000 | 84 | 31 | 21 | 20 | 20 | 126 | 42 | 26 | 20 | 24 | 18 |
| 1100 | 103 | 37 | 25 | 24 | 24 | 154 | 50 | 31 | 24 | 29 | 22 |
| 1200 | 123 | 44 | 29 | 29 | 29 | 186 | 59 | 36 | 29 | 34 | 26 |

Natural gas G20

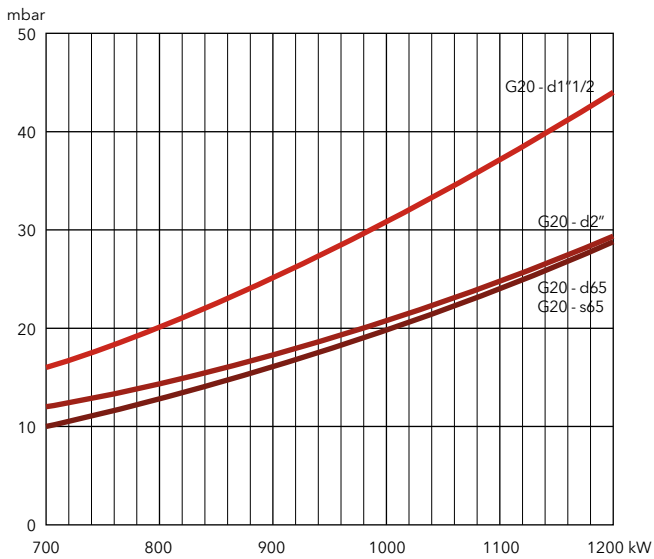

Natural gas G25

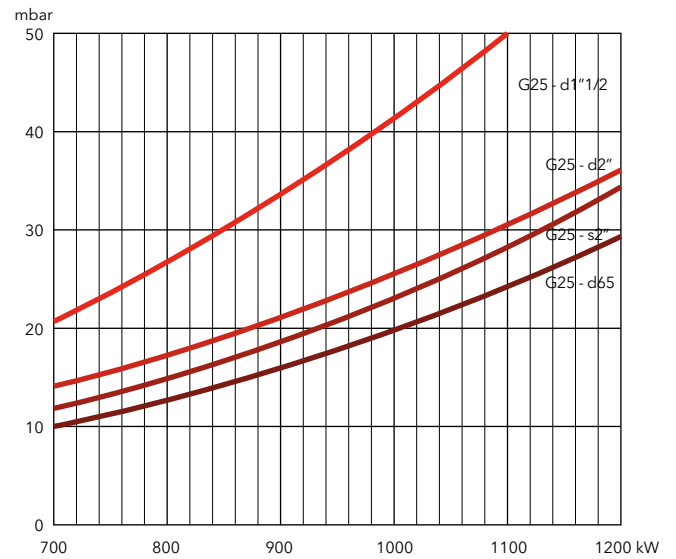

Natural gas G20, G25

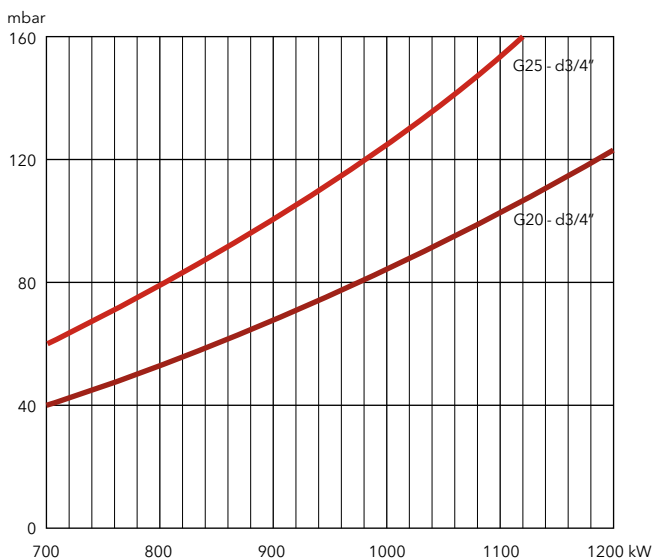

LPG

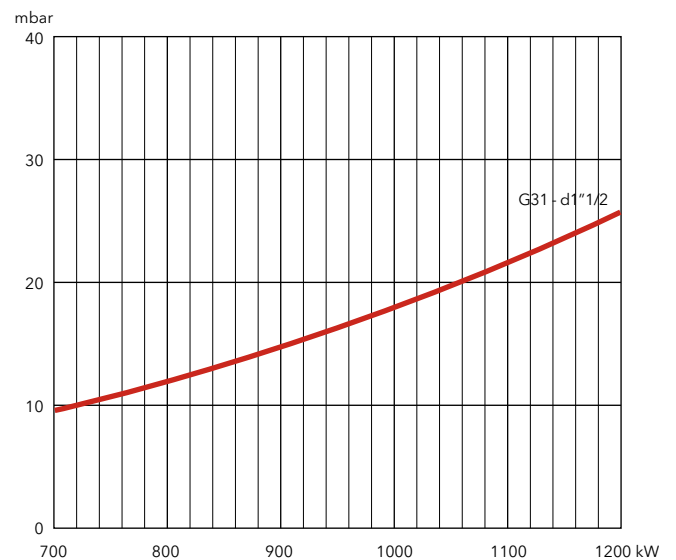

VG6.1600 M / VG6.2100 M

240 ... 1900 kW

Two stage progressive/modulating electronic



- **Fuels:** natural gas (G20/G25, $H_u = 8,83 \dots 10,35 \text{ kWh/m}^3$); LPG (G31, $H_u = 25,89 \text{ kWh/m}^3$)
- **Emissions:** $\text{NO}_x < 70 \text{ mg/kWh (NCV)}$, Low NO_x class 3 burners according to EN676
- **Operation:** two stage progressive or modulating with the installation of a power regulator and dedicated probes (see page 198), and integrated tightness control
- **Protection level:** IP 21

TECHNICAL DATA

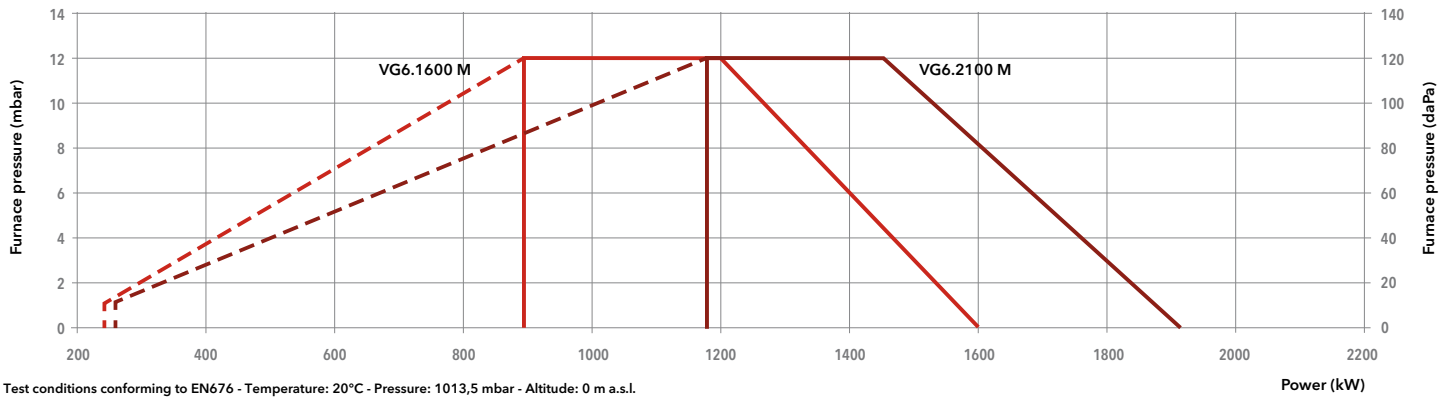

| Model | VG6.1600 M /TC | | | VG6.2100 M /TC | | | |
|-------------------------------|----------------------------|---------|---------|----------------------------|---------|---------|---------|
| Operation range | (240) 890 - 1600 kW | | | (260) 1180 - 1900 kW | | | |
| Gas pressure | 20 - 300 mbar | | | 20 - 300 mbar | | | |
| Control box / flame detection | BT3... / IRD 1020.1 | | | BT3... / IRD 1020.1 | | | |
| Fan motor | 230/400 V - 50 Hz - 2,2 kW | | | 230/400 V - 50 Hz - 2,5 kW | | | |
| Electrical consumption | 55 + 2600 W | | | 55 + 3400 W | | | |
| Acoustic level (LpA) | 77,2 dB(A) | | | 79 dB(A) | | | |
| CE certificate | 0085 CN 0192 | | | 0085 CN 0192 | | | |
| Head length | KN | KL | KM | KN | KL | KM | |
| Complete | VGD 40-065 s65-DN65/TC | 3833938 | 3833939 | 3833940 | 3833934 | 3833933 | 3833930 |
| burner code | MBC1900 d65-DN65/TC | 3833836 | 3833837 | 3833838 | 3833845 | 3833846 | 3833847 |
| | MBC1200 d2"-Rp2"/TC | 3833833 | 3833834 | 3833835 | 3833842 | 3833843 | 3833844 |
| | MBC700 d1"1/2-Rp2"/TC | 3833830 | 3833831 | 3833832 | 3833839 | 3833840 | 3833841 |

OTHER AVAILABLE VERSIONS

- Vent** Versions for continuous ventilation and post-ventilation
- PED** PED version for continuous operation

SCOPE OF SUPPLY

The burner is delivered in its package complete with:

- 1 burner head with flange seal and securing screws
- 1 compact gas train with gas filter; the gas filter is built-in for threaded valves (up to 2") and separated for flanged ones (DN65/80/100)
- 1 bag containing installation fittings
- 1 bag containing technical documentation (instruction manual, technical data, electrical diagram, exploded view and spare parts list)



DIMENSIONS (mm)

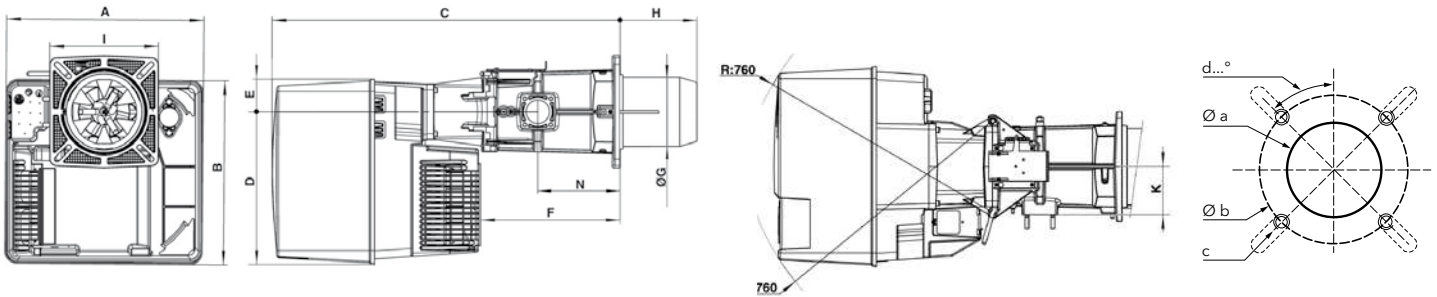

| A | B | C | D | E | F | ØG | H | | | I | K | N |
|-----|-----|------|-----|----|-----|-----|-----|-----|-----|---------|-----|-----|
| | | | | | | | KN | KM | KL | | | |
| 592 | 553 | 1050 | 456 | 97 | 421 | 227 | 360 | 460 | 560 | 326x335 | 144 | 247 |

| Øa (mm) | b (mm) | c | d |
|---------|---------|-----|-----|
| 250 | 300-400 | M12 | 45° |

Gas trains

Gas train "d":

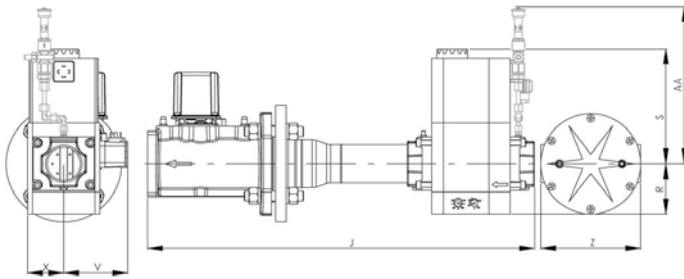

| Model | J | R | S | V | X | Z | AA* |
|-------------|-----|-----|-----|-----|----|-----|-----|
| d65-DN65 | 490 | 183 | 245 | 110 | 98 | 290 | 385 |
| d2"-Rp2" | 700 | 96 | 330 | 125 | 81 | - | 385 |
| d1"1/2-Rp2" | 622 | 80 | 185 | 102 | 57 | - | 320 |

Gas train "s":

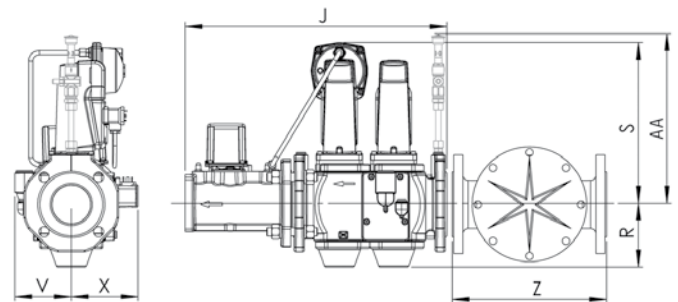

| Model | J | R | S | V | X | Z | AA* |
|----------|-----|-----|-----|-----|-----|-----|-----|
| s65-DN65 | 490 | 118 | 300 | 106 | 126 | 290 | 365 |

*: for PED configuration

PACKAGING

The burner is delivered on a pallet in three packages containing:

- burner housing
- combustion head
- gas train and filter

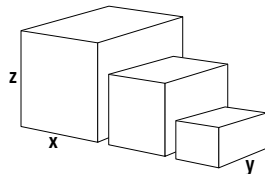

| Component | | Dimensions (mm) | | | Gross weight (kg) |
|-----------------|----------------|-----------------|-----|-----|-------------------|
| | | X | Y | Z | |
| Burner body | VG6.1600 M | 800 | 600 | 850 | 56 |
| | VG6.2100 M | 800 | 600 | 850 | 56 |
| Combustion head | KN | 1000 | 380 | 420 | 26,7 |
| | KL | 1100 | 380 | 430 | 29,4 |
| | KM | 1100 | 380 | 430 | 28 |
| Gas train | s65-DN65/TC | 790 | 600 | 500 | 29,4 |
| | d65-DN65/TC | 670 | 550 | 380 | 33 |
| | d2"-Rp2"/TC | 670 | 550 | 380 | 22 |
| | d1"1/2-Rp2"/TC | 670 | 550 | 380 | 21 |

VG6.1600 M / VG6.2100 M

240 ... 1900 kW

Two stage progressive/modulating electronic

PRESSURE LOSS [BURNER HEAD + GAS TRAIN] (mbar)

VG6.1600 M

| Burner output (kW) | Natural gas G20 Hi = 10,35 kWh/m ³ | | | | Natural gas G25 Hi = 8,83 kWh/m ³ | | | | LPG G31 Hi = 25,89 kWh/m ³ |
|--------------------|---|----------|----------|----------|--|----------|----------|----------|---------------------------------------|
| | d1"1/2-Rp2" | d2"-Rp2" | d65-DN65 | s65-DN65 | d1"1/2-Rp2" | d2"-Rp2" | d65-DN65 | s65-DN65 | d1"1/2-Rp2" |
| 800 | 16 | 9 | 6 | 6 | 22 | 12 | 8 | 8 | 8 |
| 1000 | 25 | 13 | 10 | 9 | 34 | 18 | 12 | 12 | 12 |
| 1200 | 35 | 18 | 14 | 13 | 48 | 24 | 18 | 18 | 17 |
| 1400 | 47 | 24 | 19 | 18 | 64 | 32 | 24 | 24 | 22 |
| 1600 | 61 | 31 | 25 | 23 | 83 | 42 | 31 | 31 | 29 |

Natural gas G20

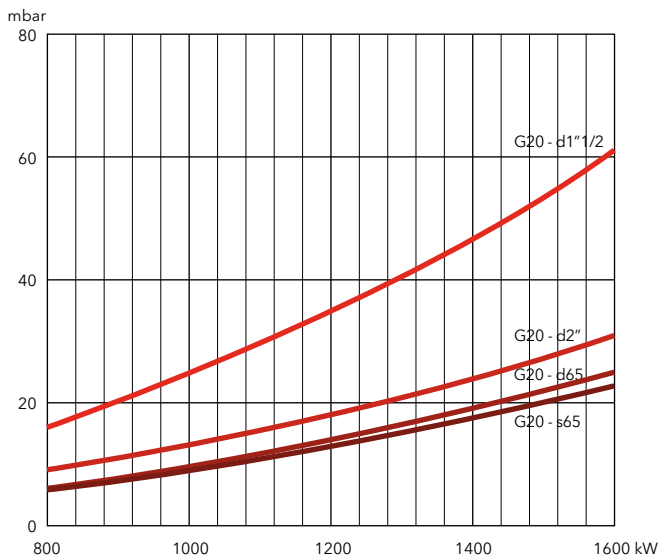

Natural gas G25

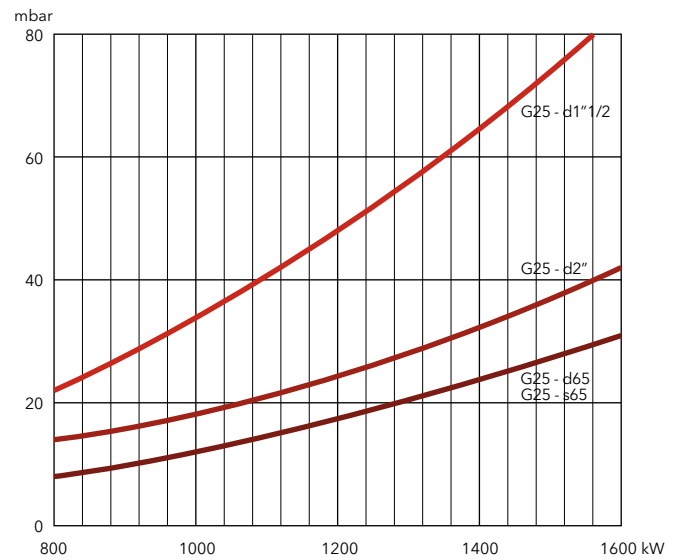

LPG

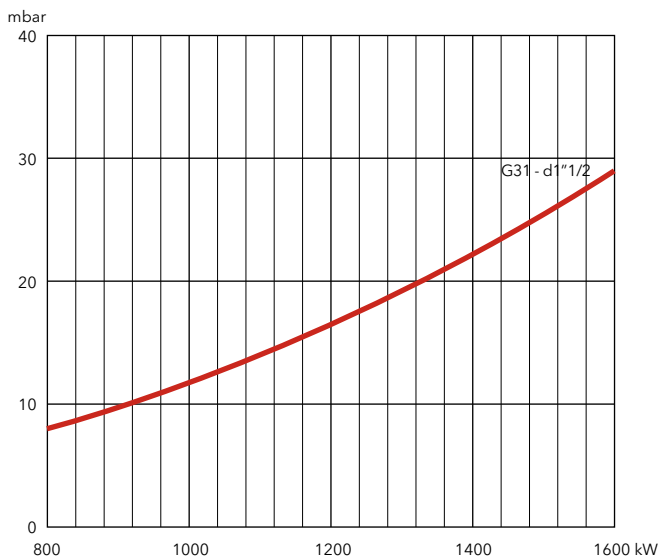



PRESSURE LOSS [BURNER HEAD + GAS TRAIN] (mbar)

VG6.2100 M

| Burner output (kW) | Natural gas G20 Hi = 10,35 kWh/m ³ | | | | Natural gas G25 Hi = 8,83 kWh/m ³ | | | | LPG G31 Hi = 25,89 kWh/m ³ | |
|--------------------|---|----------|----------|----------|--|----------|----------|----------|---------------------------------------|----------|
| | d1"1/2-Rp2" | d2"-Rp2" | d65-DN65 | s65-DN65 | d1"1/2-Rp2" | d2"-Rp2" | d65-DN65 | s65-DN65 | d1"1/2-Rp2" | d2"-Rp2" |
| 1100 | 28 | 15 | 12 | 11 | 39 | 21 | 15 | 15 | 13 | 9 |
| 1300 | 39 | 21 | 16 | 16 | 54 | 29 | 21 | 22 | 18 | 11 |
| 1500 | 51 | 27 | 21 | 21 | 71 | 37 | 28 | 29 | 23 | 14 |
| 1700 | 64 | 34 | 27 | 27 | 91 | 47 | 36 | 37 | 29 | 17 |
| 1900 | 80 | 41 | 34 | 34 | 114 | 59 | 45 | 46 | 36 | 20 |

Natural gas G20

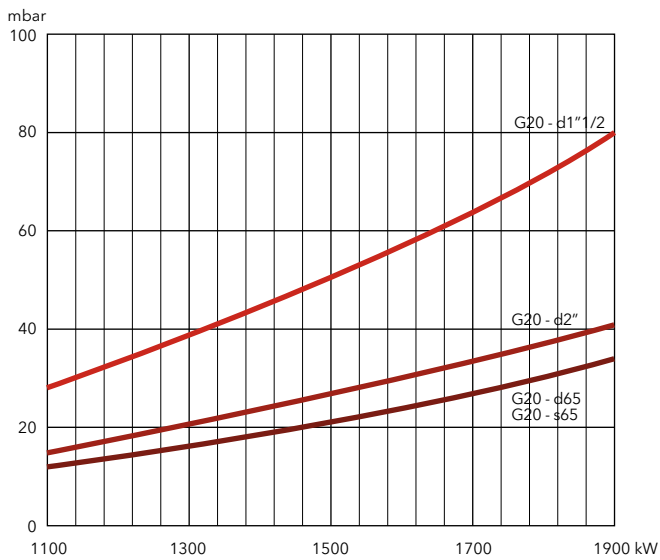

Natural gas G25

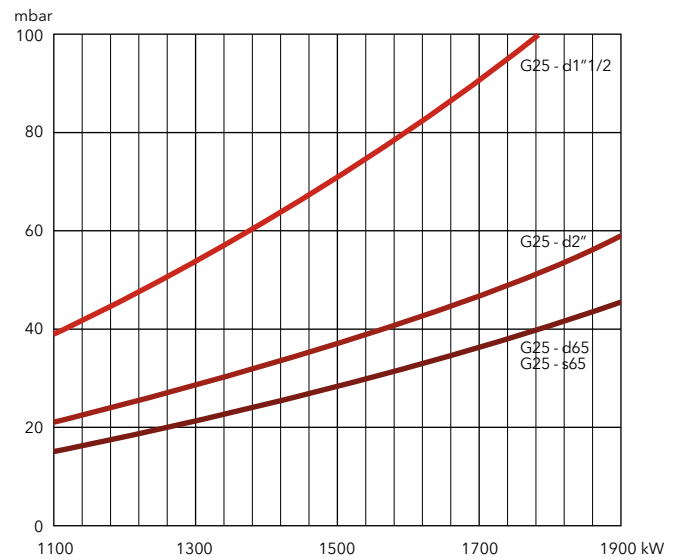

LPG

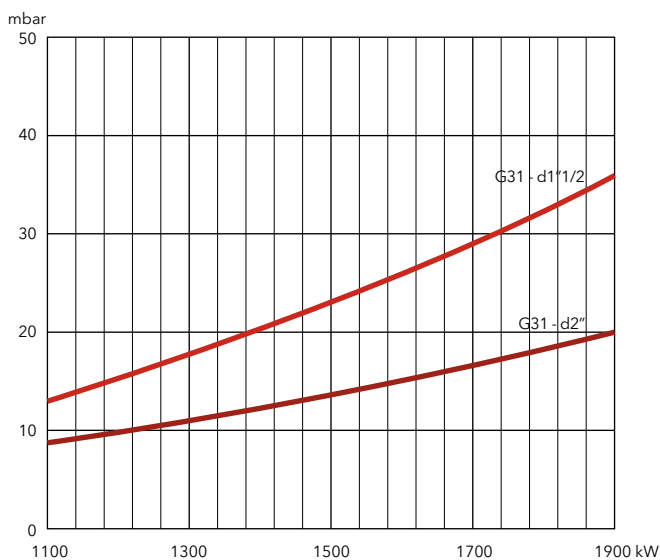

VG5.950 M V / VG5.1200 M V

160 ... 1160 kW

Two stage progressive/modulating electronic + fan speed control



- **Fuels:** natural gas (G20/G25, $H_u = 8,83...10,35 \text{ kWh/m}^3$); LPG (G31, $H_u = 25,89 \text{ kWh/m}^3$)
- **Emissions:** $\text{NO}_x < 70 \text{ mg/kWh}$ (NCV), Low NO_x class 3 burners according to EN676
- **Operation:** two stage progressive or modulating with the installation of a power regulator and dedicated probes (see page 198), fan speed control and integrated tightness control
- **Protection level:** IP 21

TECHNICAL DATA

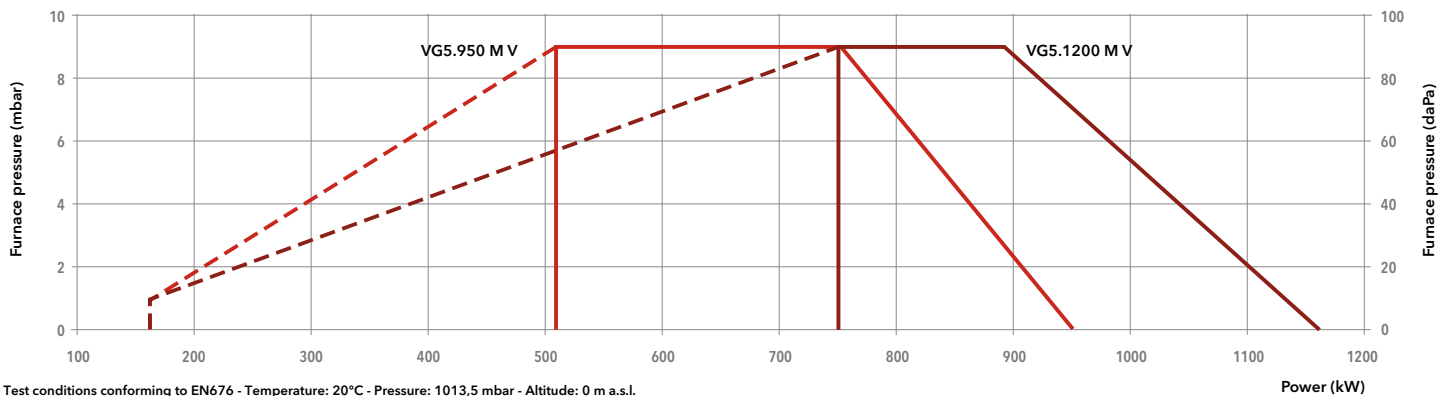

| Model | VG5.950 M V /TC | | | VG5.1200 M V /TC | | | | |
|-------------------------------|----------------------------|------------------|---------|----------------------------|---------|---------|---------|---------|
| Operation range | (160) 510 – 950 kW | | | (160) 750 – 1160 kW | | | | |
| Gas pressure | 20 – 300 mbar | | | 20 – 300 mbar | | | | |
| Control box / flame detection | BT3... / ionization | | | BT3... / ionization | | | | |
| Fan motor | 230/400 V – 50 Hz – 1,5 kW | | | 230/400 V – 50 Hz – 1,5 kW | | | | |
| Electrical consumption | 55 + 1750 W | | | 55 + 2100 W | | | | |
| Acoustic level (LpA) | 77 dB(A) | | | 77 dB(A) | | | | |
| CE certificate | 0085 CN 0192 | | | 0085 CN 0192 | | | | |
| Head length | | KN | KL | KM | KN | KL | KM | |
| Complete burner code | VGD40-065 | s65-DN65/TC | 3835235 | 3835245 | 3835255 | 3835240 | 3835250 | 3835260 |
| | MBC1900 | d65-DN65/TC | 3835236 | 3835246 | 3835256 | 3835241 | 3835251 | 3835261 |
| | MBC1200 | d2"-Rp2"/TC | 3835237 | 3835247 | 3835257 | 3835242 | 3835252 | 3835262 |
| | MBC700 | d1"1/2-Rp2"/TC | 3835238 | 3835248 | 3835258 | 3835243 | 3835253 | 3835263 |
| | MBC300 | d3/4"-Rp1"1/4/TC | 3835239 | 3835249 | 3835259 | 3835244 | 3835254 | 3835264 |

OTHER AVAILABLE VERSIONS

- Vent** Versions for continuous ventilation and post-ventilation
- PED** PED version for continuous operation

SCOPE OF SUPPLY

The burner is delivered in its package complete with:

- 1 burner head with flange seal and securing screws
- 1 compact gas train with gas filter; the gas filter is built-in for threaded valves (up to 2") and separated for flanged ones (DN65/80/100)
- 1 bag containing installation fittings
- 1 bag containing technical documentation (instruction manual, technical data, electrical diagram, exploded view and spare parts list)



DIMENSIONS (mm)

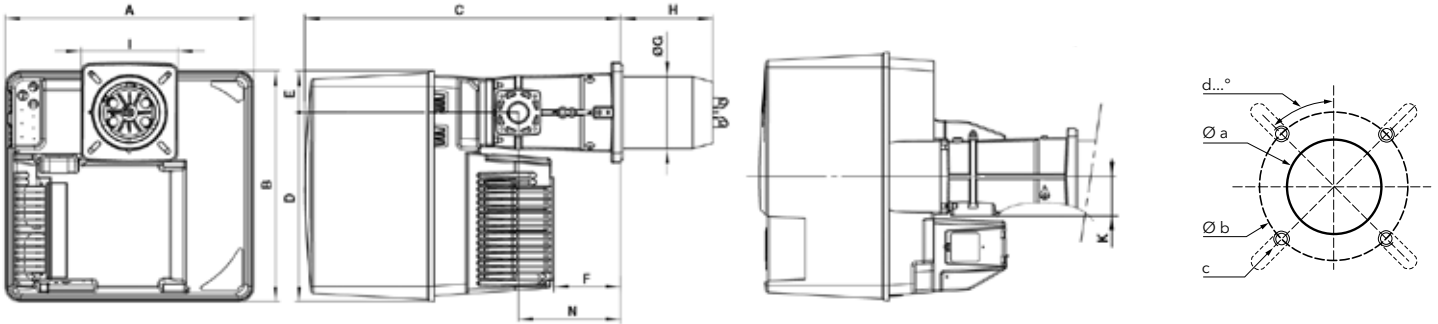

| A | B | C | D | E | F | ØG | H | | | I | K | N |
|-----|-----|-----|-----|----|-----|-----|-----|-----|-----|---------|----|-----|
| | | | | | | | KN | KM | KL | | | |
| 581 | 549 | 752 | 450 | 99 | 164 | 170 | 215 | 325 | 435 | 230x238 | 89 | 244 |

| Øa (mm) | b (mm) | c | d |
|---------|---------|-----|-----|
| 195 | 220-260 | M10 | 45° |

Gas trains

Gas train "d":

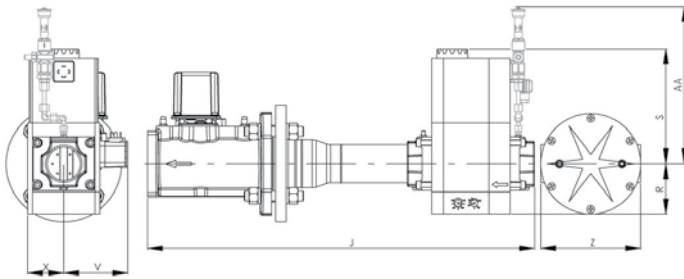

| Model | J | R | S | V | X | Z | AA* |
|---------------|-----|-----|-----|-----|----|-----|-----|
| d65-DN65 | 490 | 183 | 245 | 110 | 98 | 290 | 385 |
| d2"-Rp2" | 700 | 96 | 330 | 125 | 81 | - | 385 |
| d1"1/2-Rp2" | 622 | 80 | 185 | 102 | 57 | - | 320 |
| d3/4"-Rp1"1/4 | 460 | 60 | 173 | 88 | 58 | - | 320 |

Gas train "s":

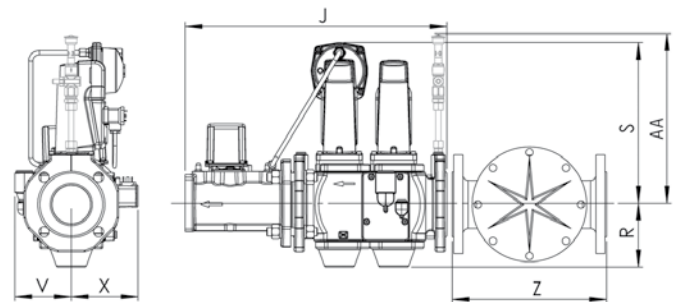

| Model | J | R | S | V | X | Z | AA* |
|----------|-----|-----|-----|-----|-----|-----|-----|
| s65-DN65 | 490 | 118 | 300 | 106 | 126 | 290 | 365 |

*: for PED configuration

PACKAGING

The burner is delivered on a pallet in three packages containing:

- burner housing
- combustion head
- gas train and filter

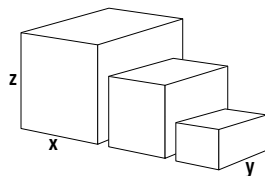

| Component | | Dimensions (mm) | | | Gross weight (kg) |
|-----------------|------------------|-----------------|-----|-----|-------------------|
| | | X | Y | Z | |
| Burner body | VG5.950 M V | 800 | 600 | 850 | 56 |
| | VG5.1200 M V | 800 | 600 | 850 | 56 |
| Combustion head | KN | 780 | 265 | 280 | 12,3 |
| | KL | 1010 | 265 | 280 | 14,4 |
| | KM | 1010 | 265 | 280 | 13,4 |
| Gas train | s65-DN65/TC | 670 | 550 | 380 | 29 |
| | d65-DN65/TC | 670 | 550 | 380 | 33 |
| | d2"-Rp2"/TC | 670 | 550 | 380 | 22 |
| | d1"1/2-Rp2"/TC | 670 | 550 | 380 | 21 |
| | d3/4"-Rp1"1/4/TC | 590 | 290 | 180 | 12 |

VG5.950 M V / VG5.1200 M V

160 ... 1160 kW

Two stage progressive/modulating electronic + fan speed control

PRESSURE LOSS [BURNER HEAD + GAS TRAIN] (mbar)

VG5.950 M V

| Burner output (kW) | Natural gas G20 Hi = 10,35 kWh/m ³ | | | | | Natural gas G25 Hi = 8,83 kWh/m ³ | | | | | LPG G31 |
|--------------------|---|-------------|----------|----------|----------|--|-------------|----------|----------|----------|-------------|
| | d3/4-Rp1"1/4 | d1"1/2-Rp2" | d2"-Rp2" | d65-DN65 | s65-DN65 | d3/4-Rp1"1/4 | d1"1/2-Rp2" | d2"-Rp2" | d65-DN65 | s65-DN65 | d1"1/2-Rp2" |
| 500 | 31 | 9 | 8 | 5 | 5 | 37 | 11 | 9 | 5 | 6 | 6 |
| 600 | 43 | 13 | 10 | 8 | 8 | 53 | 16 | 12 | 7 | 9 | 8 |
| 700 | 58 | 17 | 13 | 10 | 10 | 73 | 21 | 15 | 10 | 12 | 10 |
| 800 | 76 | 22 | 16 | 13 | 13 | 96 | 28 | 19 | 13 | 16 | 13 |
| 900 | 97 | 27 | 19 | 17 | 17 | 124 | 35 | 23 | 17 | 20 | 16 |

Natural gas G20

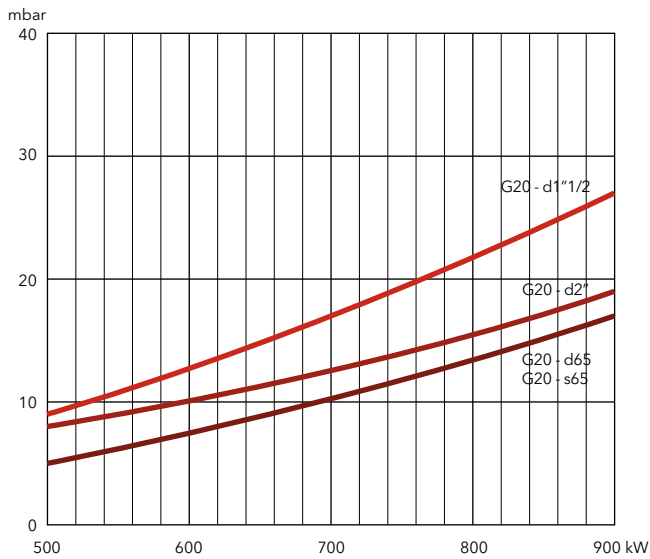

Natural gas G25

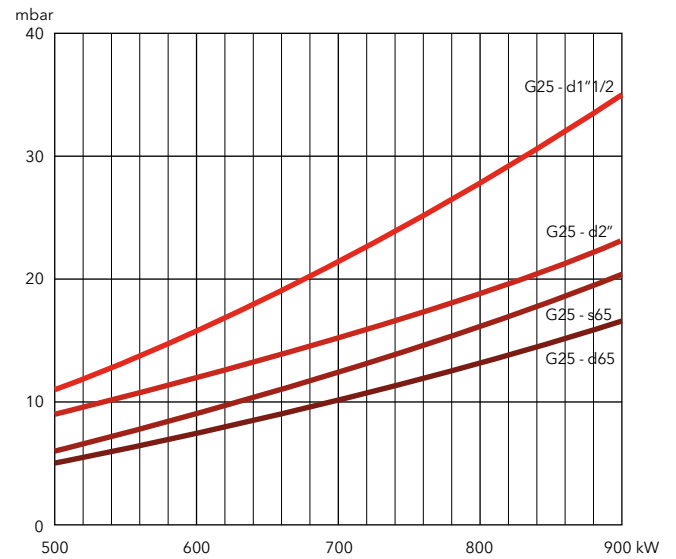

Natural gas G20, G25

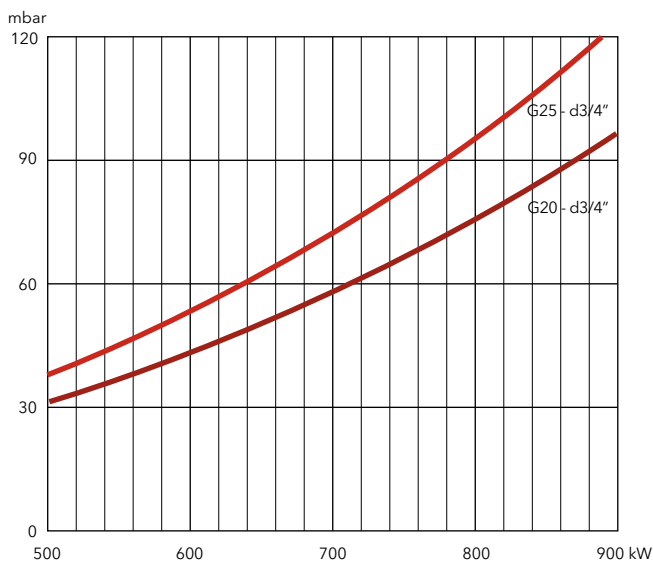

LPG

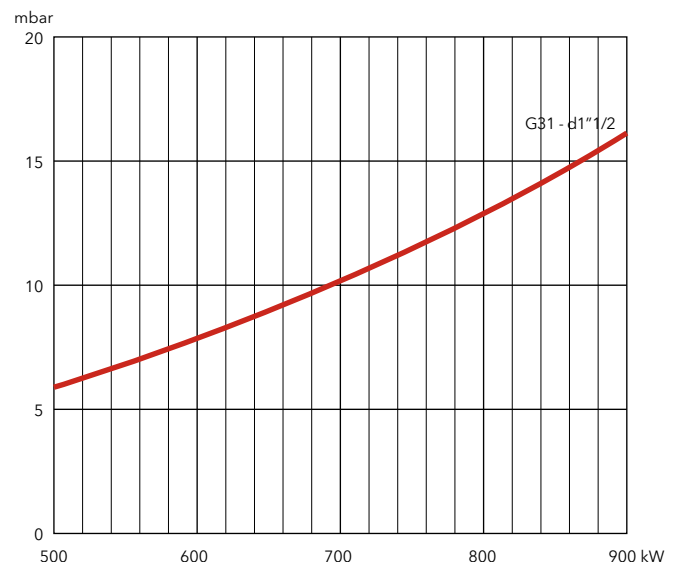



PRESSURE LOSS [BURNER HEAD + GAS TRAIN] (mbar)

VG5.1200 M V

| Burner output (kW) | Natural gas G20 Hi = 10,35 kWh/m ³ | | | | | Natural gas G25 Hi = 8,83 kWh/m ³ | | | | | LPG G31 |
|--------------------|---|-------------|----------|----------|----------|--|-------------|----------|----------|----------|-------------|
| | d3/4-Rp1"1/4 | d1"1/2-Rp2" | d2"-Rp2" | d65-DN65 | s65-DN65 | d3/4-Rp1"1/4 | d1"1/2-Rp2" | d2"-Rp2" | d65-DN65 | s65-DN65 | d1"1/2-Rp2" |
| 700 | 40 | 16 | 12 | 10 | 10 | 60 | 21 | 14 | 10 | 12 | 10 |
| 800 | 53 | 20 | 14 | 13 | 13 | 79 | 27 | 17 | 13 | 15 | 12 |
| 900 | 68 | 25 | 17 | 16 | 16 | 100 | 34 | 21 | 16 | 19 | 15 |
| 1000 | 84 | 31 | 21 | 20 | 20 | 126 | 42 | 26 | 20 | 24 | 18 |
| 1100 | 103 | 37 | 25 | 24 | 24 | 154 | 50 | 31 | 24 | 29 | 22 |
| 1200 | 123 | 44 | 29 | 29 | 29 | 186 | 59 | 36 | 29 | 34 | 26 |

Natural gas G20

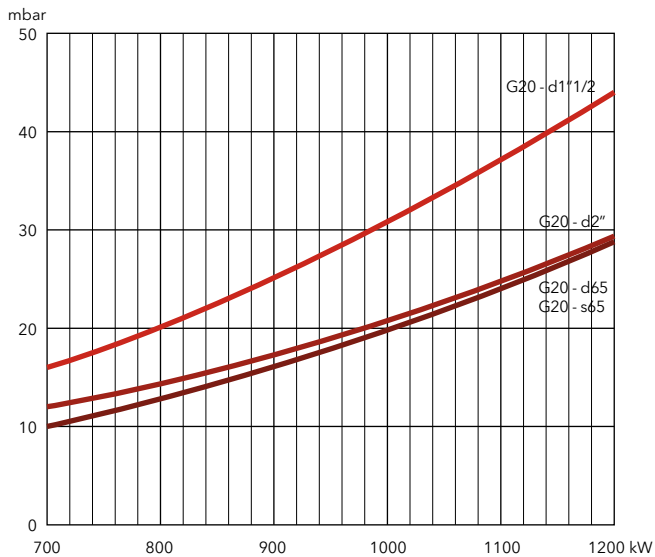

Natural gas G25

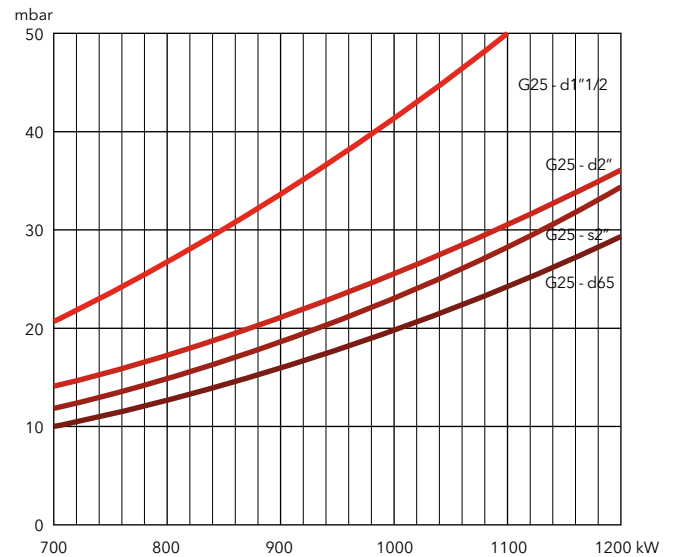

Natural gas G20, G25

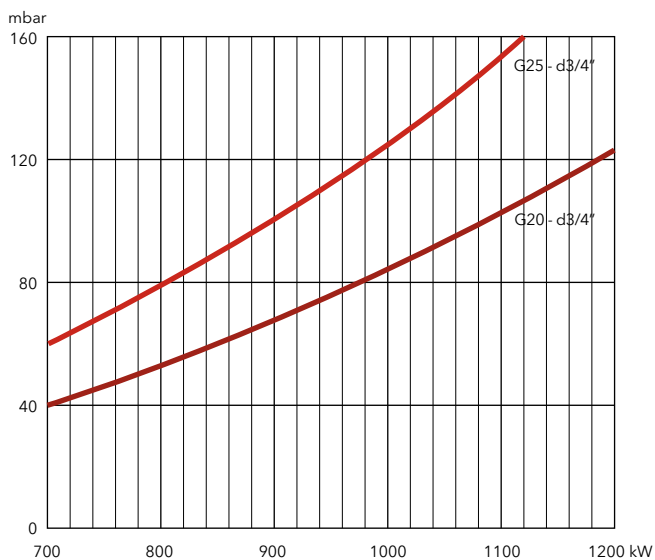

LPG

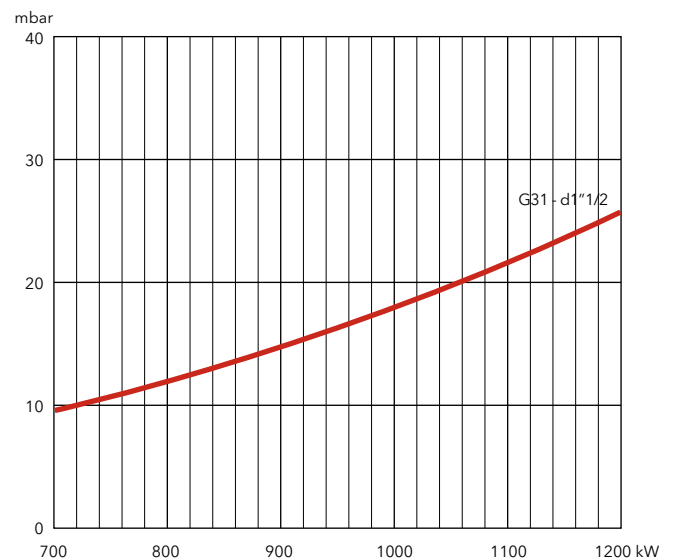

VG6.1600 M V / VG6.2100 M V

240 ... 1900 kW

Two stage progressive/modulating electronic + fan speed control



- **Fuels:** natural gas (G20/G25, $H_u = 8,83...10,35 \text{ kWh/m}^3$); LPG (G31, $H_u = 25,89 \text{ kWh/m}^3$)
- **Emissions:** NOx < 70 mg/kWh (NCV), Low NOx class 3 burners according to EN676
- **Operation:** two stage progressive or modulating with the installation of a power regulator and dedicated probes (see page 198), fan speed control and integrated tightness control
- **Protection level:** IP 21

TECHNICAL DATA

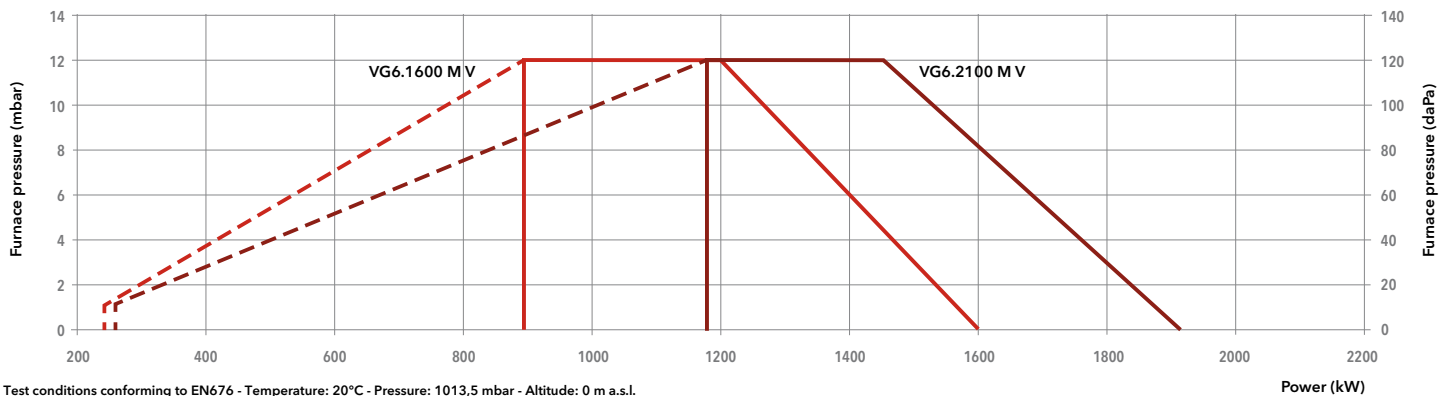

| Model | VG6.1600 M V /TC | | | VG6.2100 M V /TC | | | | |
|-------------------------------|----------------------------|----------------|---------|----------------------------|---------|---------|---------|---------|
| Operation range | (240) 890 - 1600 kW | | | (260) 1180 - 1900 kW | | | | |
| Gas pressure | 20 - 300 mbar | | | 20 - 300 mbar | | | | |
| Control box / flame detection | BT3... / IRD 1020.1 | | | BT3... / IRD 1020.1 | | | | |
| Fan motor | 230/400 V - 50 Hz - 2,2 kW | | | 230/400 V - 50 Hz - 2,5 kW | | | | |
| Electrical consumption | 55 + 2600 W | | | 55 + 3400 W | | | | |
| Acoustic level (LpA) | 77,2 dB(A) | | | 79 dB(A) | | | | |
| CE certificate | 0085 CN 0192 | | | 0085 CN 0192 | | | | |
| Head length | | KN | KL | KM | KN | KL | KM | |
| Complete | VGD 40-065 | s65-DN65/TC | 3835265 | 3835273 | 3835281 | 3835269 | 3835277 | 3835285 |
| burner code | MBC1900 | d65-DN65/TC | 3835266 | 3835274 | 3835282 | 3835270 | 3835278 | 3835286 |
| | MBC1200 | d2"-Rp2"/TC | 3835267 | 3835275 | 3835283 | 3835271 | 3835279 | 3835287 |
| | MBC700 | d1"1/2-Rp2"/TC | 3835268 | 3835276 | 3835284 | 3835272 | 3835280 | 3835288 |

OTHER AVAILABLE VERSIONS

- Vent** Versions for continuous ventilation and post-ventilation
- PED** PED version for continuous operation

SCOPE OF SUPPLY

The burner is delivered in its package complete with:

- 1 burner head with flange seal and securing screws
- 1 compact gas train with gas filter; the gas filter is built-in for threaded valves (up to 2") and separated for flanged ones (DN65/80/100)
- 1 bag containing installation fittings
- 1 bag containing technical documentation (instruction manual, technical data, electrical diagram, exploded view and spare parts list)



DIMENSIONS (mm)

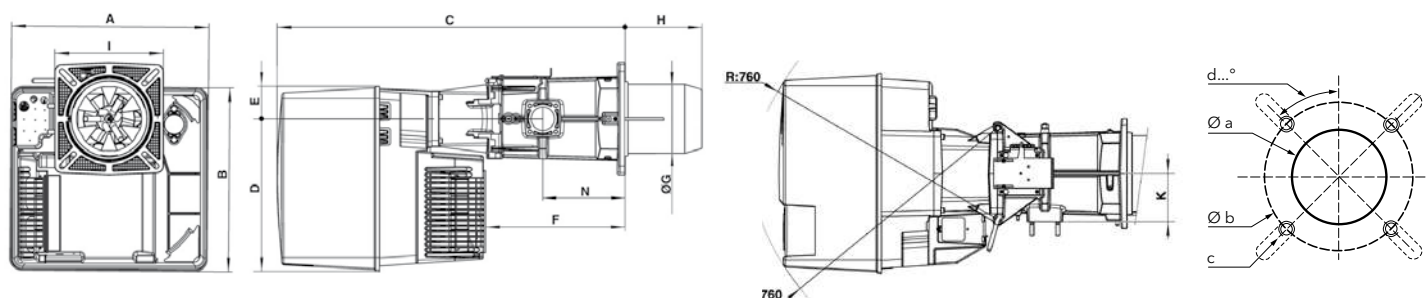

| A | B | C | D | E | F | ØG | H | | | I | K | N |
|-----|-----|------|-----|----|-----|-----|-----|-----|-----|---------|-----|-----|
| | | | | | | | KN | KM | KL | | | |
| 592 | 553 | 1050 | 456 | 97 | 421 | 227 | 360 | 460 | 560 | 326x335 | 144 | 247 |

| Øa (mm) | b (mm) | c | d |
|---------|---------|-----|-----|
| 250 | 300-400 | M12 | 45° |

Gas trains

Gas train "d":

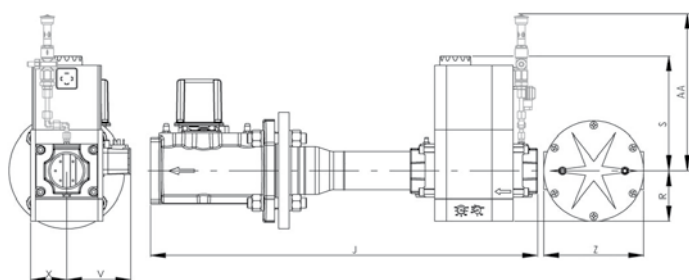

| Model | J | R | S | V | X | Z | AA* |
|-------------|-----|-----|-----|-----|----|-----|-----|
| d65-DN65 | 490 | 183 | 245 | 110 | 98 | 290 | 385 |
| d2"-Rp2" | 700 | 96 | 330 | 125 | 81 | - | 385 |
| d1"1/2-Rp2" | 622 | 80 | 185 | 102 | 57 | - | 320 |

Gas train "s":

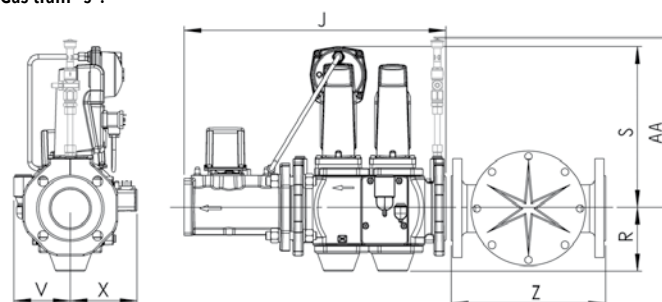

| Model | J | R | S | V | X | Z | AA* |
|----------|-----|-----|-----|-----|-----|-----|-----|
| s65-DN65 | 490 | 118 | 300 | 106 | 126 | 290 | 365 |

*: for PED configuration

PACKAGING

The burner is delivered on a pallet in three packages containing:

- burner housing
- combustion head
- gas train and filter

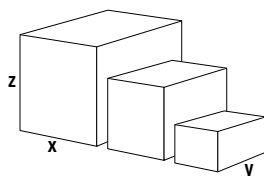

| Component | | Dimensions (mm) | | | Gross weight (kg) |
|-----------------|----------------|-----------------|-----|-----|-------------------|
| | | X | Y | Z | |
| Burner body | VG6.1600 M V | 800 | 600 | 850 | 56 |
| | VG6.2100 M V | 800 | 600 | 850 | 56 |
| Combustion head | KN | 1000 | 380 | 420 | 26,7 |
| | KL | 1100 | 380 | 430 | 29,4 |
| | KM | 1100 | 380 | 430 | 28 |
| Gas train | s65-DN65/TC | 670 | 550 | 380 | 29,4 |
| | d65-DN65/TC | 670 | 550 | 380 | 33 |
| | d2"-Rp2"/TC | 670 | 550 | 380 | 22 |
| | d1"1/2-Rp2"/TC | 670 | 550 | 380 | 21 |

VG6.1600 M V / VG6.2100 M V

240 ... 1900 kW

Two stage progressive/modulating electronic + fan speed control

PRESSURE LOSS [BURNER HEAD + GAS TRAIN] (mbar)

VG6.1600 M V

| Burner output (kW) | Natural gas G20 Hi = 10,35 kWh/m ³ | | | | Natural gas G25 Hi = 8,83 kWh/m ³ | | | | LPG G31 Hi = 25,89 kWh/m ³ |
|--------------------|---|----------|----------|----------|--|----------|----------|----------|---------------------------------------|
| | d1"1/2-Rp2" | d2"-Rp2" | d65-DN65 | s65-DN65 | d1"1/2-Rp2" | d2"-Rp2" | d65-DN65 | s65-DN65 | d1"1/2-Rp2" |
| 800 | 16 | 9 | 6 | 6 | 22 | 12 | 8 | 8 | 8 |
| 1000 | 25 | 13 | 10 | 9 | 34 | 18 | 12 | 12 | 12 |
| 1200 | 35 | 18 | 14 | 13 | 48 | 24 | 18 | 18 | 17 |
| 1400 | 47 | 24 | 19 | 18 | 64 | 32 | 24 | 24 | 22 |
| 1600 | 61 | 31 | 25 | 23 | 83 | 42 | 31 | 31 | 29 |

Natural gas G20

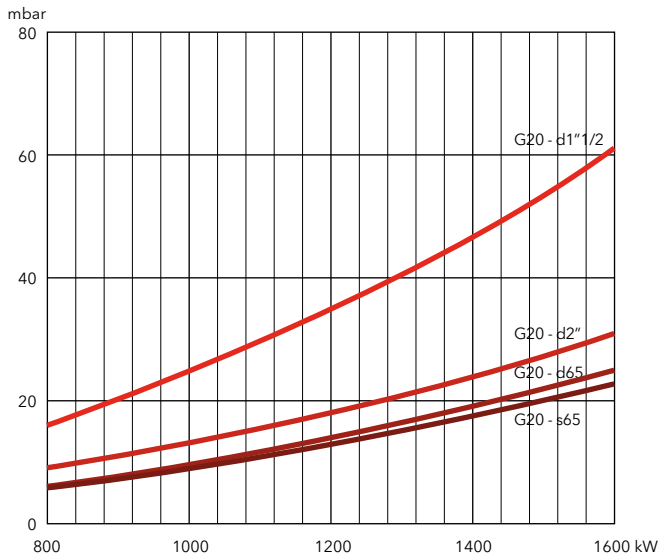

Natural gas G25

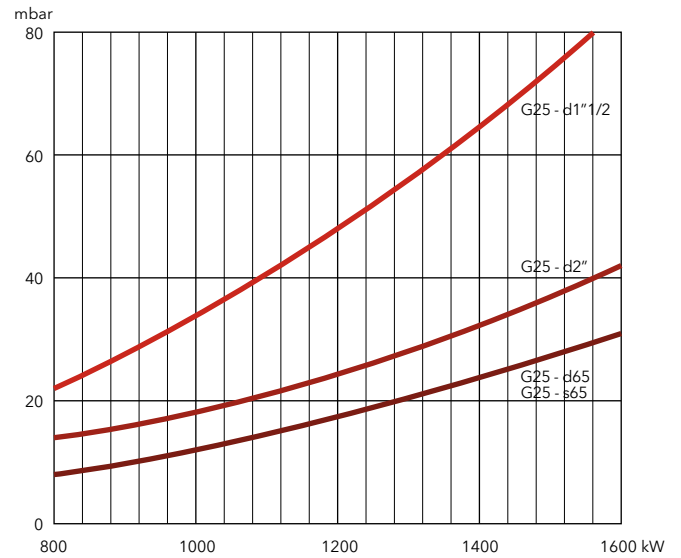

LPG

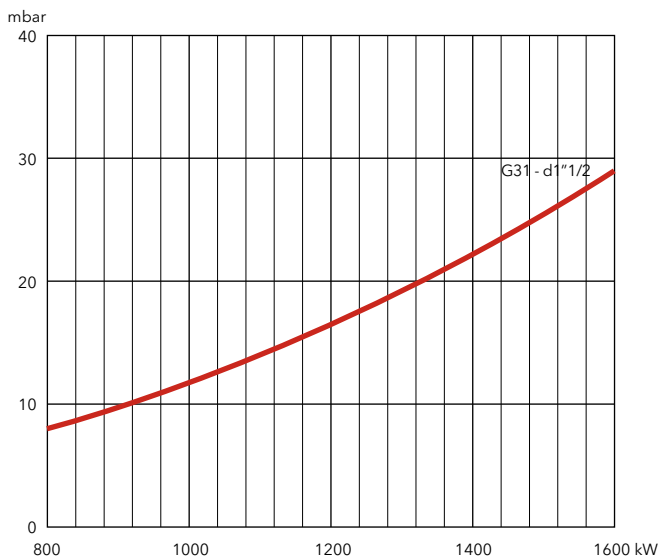



PRESSURE LOSS [BURNER HEAD + GAS TRAIN] (mbar)

VG6.2100 M V

| Burner output (kW) | Natural gas G20 Hi = 10,35 kWh/m ³ | | | | Natural gas G25 Hi = 8,83 kWh/m ³ | | | | LPG G31 Hi = 25,89 kWh/m ³ | |
|--------------------|---|----------|----------|----------|--|----------|----------|----------|---------------------------------------|----------|
| | d1"1/2-Rp2" | d2"-Rp2" | d65-DN65 | s65-DN65 | d1"1/2-Rp2" | d2"-Rp2" | d65-DN65 | s65-DN65 | d1"1/2-Rp2" | d2"-Rp2" |
| 1100 | 28 | 15 | 12 | 11 | 39 | 21 | 15 | 15 | 13 | 9 |
| 1300 | 39 | 21 | 16 | 16 | 54 | 29 | 21 | 22 | 18 | 11 |
| 1500 | 51 | 27 | 21 | 21 | 71 | 37 | 28 | 29 | 23 | 14 |
| 1700 | 64 | 34 | 27 | 27 | 91 | 47 | 36 | 37 | 29 | 17 |
| 1900 | 80 | 41 | 34 | 34 | 114 | 59 | 45 | 46 | 36 | 20 |

Natural gas G20

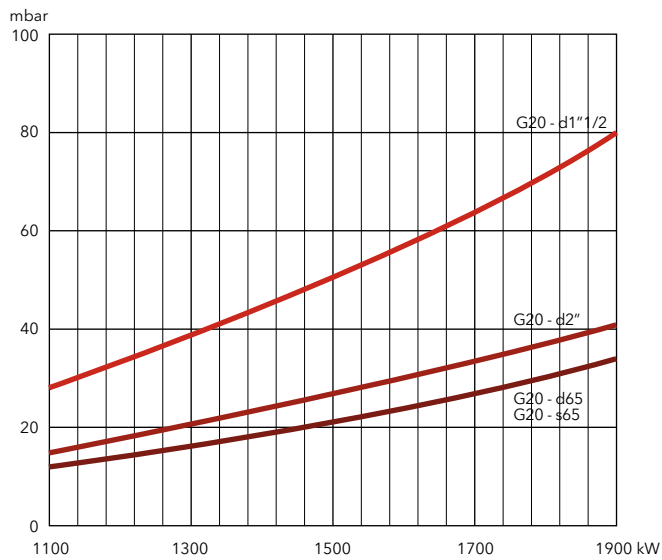

Natural gas G25

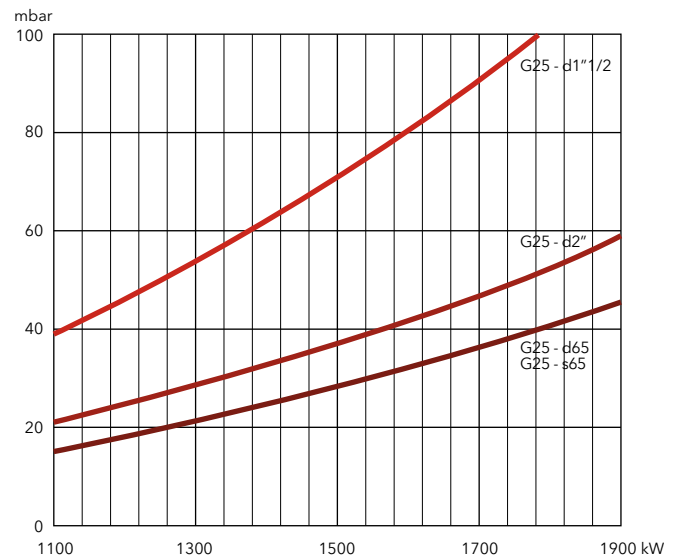

LPG

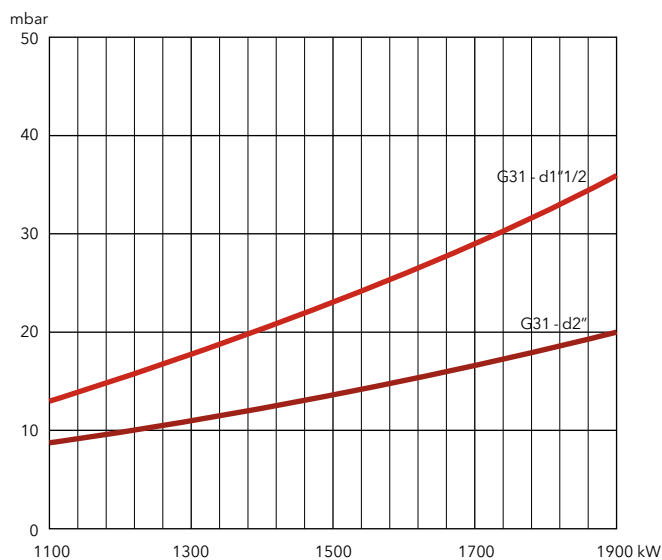

VG5.950 DP R / VG5.1200 DP R

150 ... 1200 kW
2 stage progressive/modulating pneumatic

- **Fuels:** natural gas (G20/G25, $H_u = 8,83...10,35 \text{ kWh/m}^3$); LPG (G31, $H_u = 25,89 \text{ kWh/m}^3$)
- **Emissions:** $\text{NO}_x < 120 \text{ mg/kWh}$ (NCV), Low NO_x class 2 burners according to EN676
- **Operation:** two stage progressive or modulating with the installation of a power regulator and dedicated probes (see page 198)
- **Protection level:** IP 21



TECHNICAL DATA

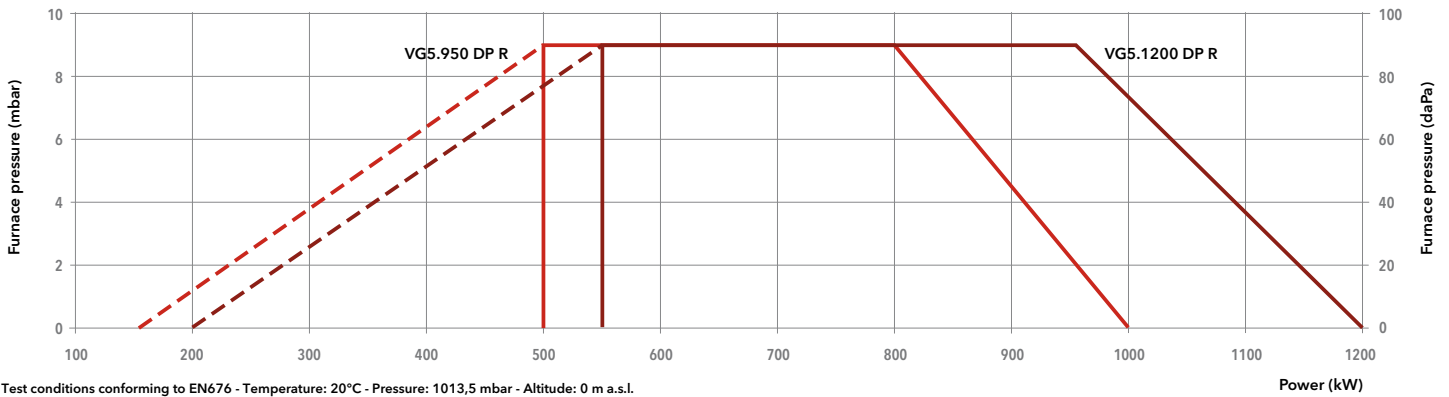

| Model | VG5.950 DP R | | | VG5.1200 DP R | | |
|-------------------------------|----------------------------|---------|---------|----------------------------|---------|---------|
| Operation range | (150) 500 – 1000 kW | | | (200) 550 – 1200 kW | | |
| Gas pressure | 20 – 500 mbar | | | 20 – 500 mbar | | |
| Control box / flame detection | TCG 5.. / ionization | | | TCG 5.. / ionization | | |
| Fan motor | 230/400 V – 50 Hz – 1,5 kW | | | 230/400 V – 50 Hz – 1,5 kW | | |
| Electrical consumption | 100 + 2200 W | | | 100 + 2300 W | | |
| Acoustic level (LpA) | 77 dB(A) | | | 77 dB(A) | | |
| CE certificate | 0085 CQ 0570 | | | 0085 CQ 0570 | | |
| Head length | KN | KL | KM | KN | KL | KM |
| Complete burner code | VGD 40-065 s65-DN65 | - | - | 3835377 | 3835378 | 3835379 |
| | VGD 20-5011 s2"-Rp2" | 3835357 | 3835366 | 3835380 | 3835381 | 3835382 |
| | MB-VEF 420 d1"1/2-Rp2" | 3835368 | 3835369 | 3835370 | 3835383 | 3835385 |
| | MB-VEF 412 d1"1/4-Rp2" | 3835371 | 3835372 | 3835373 | 3835386 | 3835387 |
| | MB-VEF 407 d3/4"-Rp1" | 3835374 | 3835375 | 3835376 | - | - |

OTHER AVAILABLE VERSIONS

- 60 60 Hz version
- TC Version with tightness control
- V_{vent} Versions for continuous ventilation and post-ventilation

SCOPE OF SUPPLY

The burner is delivered in its package complete with:

- 1 burner head with flange seal and securing screws
- 1 compact gas train with gas filter; the gas filter is built-in for threaded valves (up to 2") and separated for flanged ones (DN65/80/100)
- 1 bag containing installation fittings
- 1 bag containing technical documentation (instruction manual, technical data, electrical diagram, exploded view and spare parts list)

DIMENSIONS (mm)

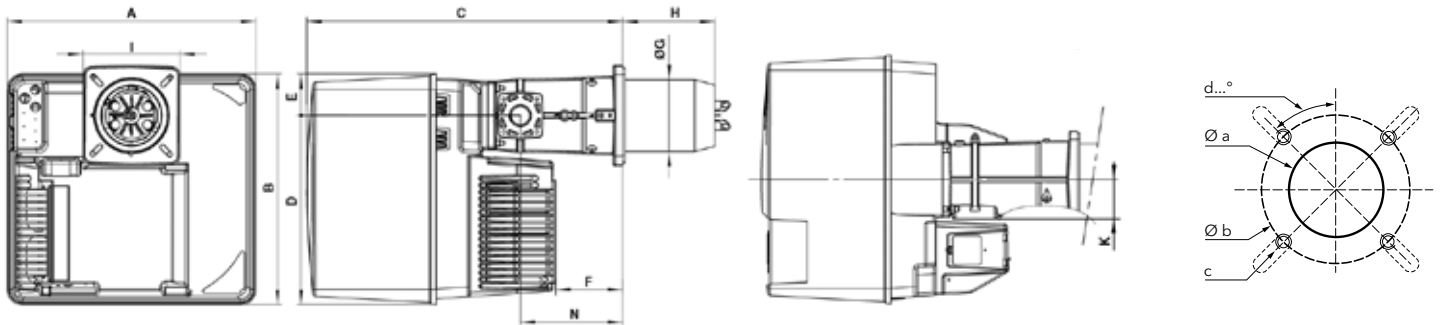

| A | B | C | D | E | F | ØG | H | | | I | K | N |
|-----|-----|-----|-----|----|-----|-----|-----|-----|-----|---------|----|-----|
| | | | | | | | KN | KM | KL | | | |
| 581 | 549 | 752 | 450 | 99 | 164 | 170 | 215 | 325 | 435 | 230x238 | 89 | 244 |

| Øa (mm) | b (mm) | c | d |
|---------|---------|-----|-----|
| 195 | 220-260 | M10 | 45° |

Gas trains

Gas train "d":

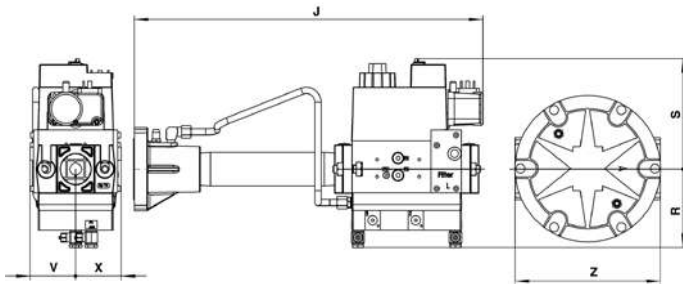

| Model | J | R | S | V | X | Z |
|-------------|-----|-----|-----|----|----|-----|
| d1"1/2-Rp2" | 540 | 123 | 190 | 55 | 55 | - |
| d1"1/4-Rp2" | 450 | 100 | 141 | 58 | 58 | 186 |
| d3/4"-Rp1" | 420 | 100 | 122 | 55 | 50 | 160 |

Gas train "s":

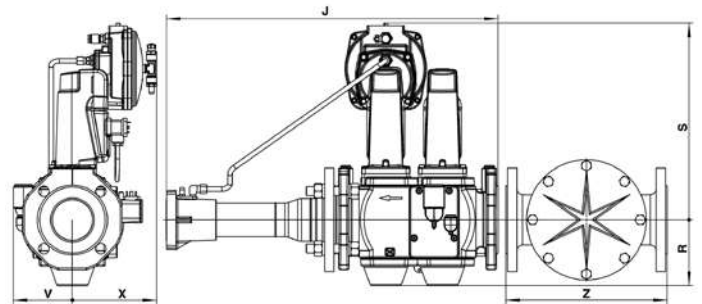

| Model | J | R | S | V | X | Z |
|----------|-----|-----|-----|-----|-----|-----|
| s65-DN65 | 600 | 135 | 360 | 110 | 150 | 290 |
| s2"-Rp2" | 612 | 103 | 330 | 110 | 150 | 186 |

PACKAGING

The burner is delivered on a pallet in three packages containing:

- burner housing
- combustion head
- gas train and filter

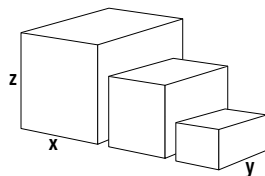

| Component | | Dimensions (mm) | | | Gross weight (kg) |
|-----------------|---------------|-----------------|-----|-----|-------------------|
| | | X | Y | Z | |
| Burner body | VG5.950 DP R | 800 | 600 | 850 | 55 |
| | VG5.1200 DP R | 800 | 600 | 850 | 56 |
| Combustion head | KN | 780 | 265 | 280 | 12,3 |
| | KL | 1010 | 265 | 280 | 14,4 |
| | KM | 1010 | 265 | 280 | 13,4 |
| Gas train | s65-DN65 | 670 | 530 | 380 | 29 |
| | s2"-Rp2" | 670 | 530 | 380 | 17,2 |
| | d1"1/2-Rp2" | 400 | 570 | 200 | 12 |
| | d1"1/4-Rp2" | 590 | 390 | 180 | 12 |
| | d3/4"-Rp1" | 590 | 390 | 180 | 7 |

VG5.950 DP R / VG5.1200 DP R

150 ... 1200 kW

2 stage progressive/modulating pneumatic

PRESSURE LOSS [BURNER HEAD + GAS TRAIN] (mbar)

VG5.950 DP R

| Burner output (kW) | Natural gas G20 Hi = 10,35 kWh/m ³ | | | | Natural gas G25 Hi = 8,83 kWh/m ³ | | | | LPG G31 Hi= 25,89 kWh/m ³ | | | |
|--------------------|---|-------------|-------------|----------|--|-------------|-------------|----------|--------------------------------------|-------------|-------------|----------|
| | d3/4"-Rp1" | d1"1/4-Rp2" | d1"1/2-Rp2" | s2"-Rp2" | d3/4"-Rp1" | d1"1/4-Rp2" | d1"1/2-Rp2" | s2"-Rp2" | d3/4"-Rp1" | d1"1/4-Rp2" | d1"1/2-Rp2" | s2"-Rp2" |
| 500 | 87 | 18 | 11 | 7 | 129 | 26 | 15 | 11 | 40 | 11 | 8 | 7 |
| 600 | 120 | 24 | 14 | 10 | 179 | 36 | 21 | 15 | 55 | 15 | 11 | 9 |
| 700 | 167 | 34 | 20 | 14 | 248 | 51 | 30 | 21 | 77 | 21 | 15 | 13 |
| 800 | 214 | 43 | 25 | 18 | - | 65 | 38 | 27 | 98 | 27 | 19 | 16 |
| 900 | - | 56 | 33 | 23 | - | 83 | 48 | 34 | 126 | 35 | 25 | 21 |
| 1000 | - | 68 | 40 | 28 | - | 101 | 59 | 42 | 153 | 42 | 30 | 26 |

Natural gas G20

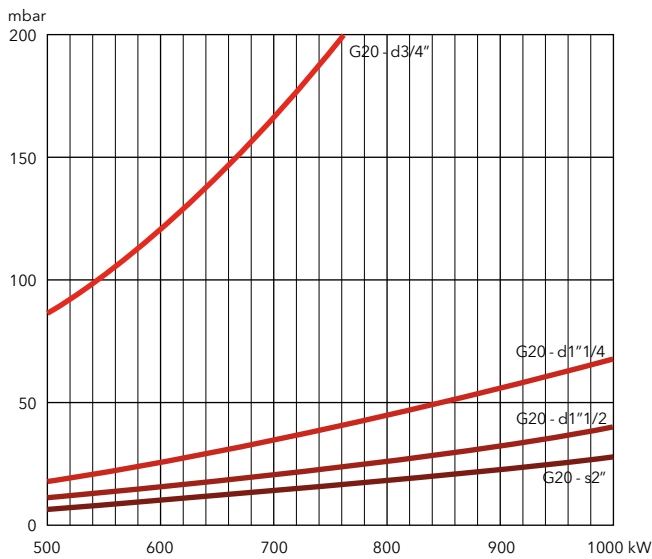

Natural gas G25

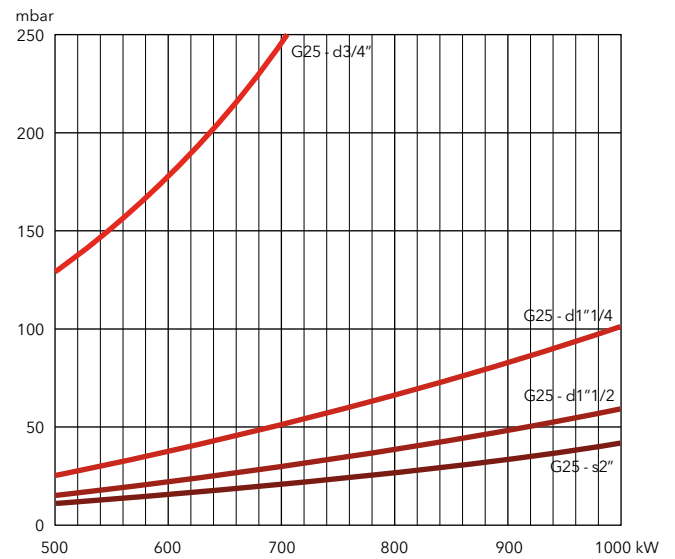

LPG

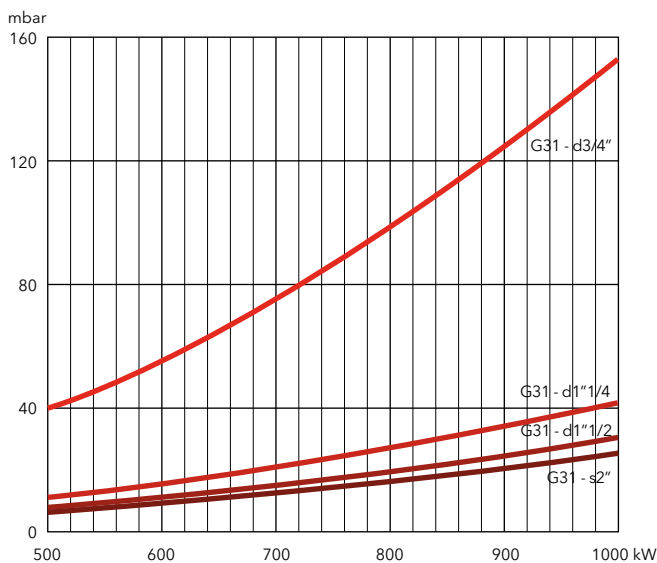



PRESSURE LOSS [BURNER HEAD + GAS TRAIN] (mbar)

VG5.1200 DP R

| Burner output (kW) | Natural gas G20 Hi = 10,35 kWh/m ³ | | | | Natural gas G25 Hi = 8,83 kWh/m ³ | | | | LPG G31 Hi = 25,89 kWh/m ³ | | |
|--------------------|---|-------------|----------|----------|--|-------------|----------|----------|---------------------------------------|-------------|----------|
| | d1"1/4-Rp2" | d1"1/2-Rp2" | s2"-Rp2" | s65-Rp2" | d1"1/4-Rp2" | d1"1/2-Rp2" | s2"-Rp2" | s65-Rp2" | d1"1/4-Rp2" | d1"1/2-Rp2" | s2"-Rp2" |
| 700 | 30 | 16 | 10 | 8 | 45 | 24 | 16 | 12 | 16 | 10 | 8 |
| 800 | 39 | 21 | 14 | 10 | 58 | 32 | 20 | 16 | 21 | 13 | 10 |
| 900 | 50 | 27 | 18 | 13 | 74 | 40 | 26 | 20 | 26 | 17 | 13 |
| 1000 | 61 | 33 | 21 | 16 | 91 | 49 | 32 | 25 | 33 | 21 | 16 |
| 1100 | 74 | 40 | 26 | 20 | 110 | 60 | 39 | 30 | 40 | 26 | 19 |
| 1200 | 88 | 48 | 31 | 24 | 132 | 71 | 46 | 35 | 47 | 30 | 23 |

Natural gas G20

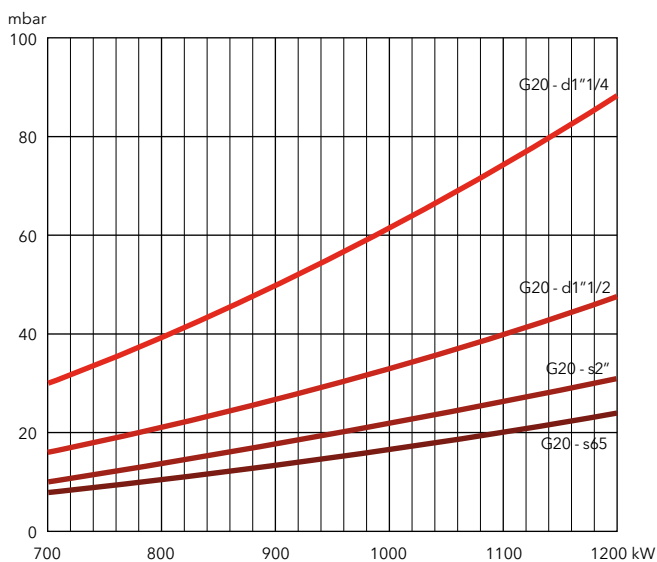

Natural gas G25

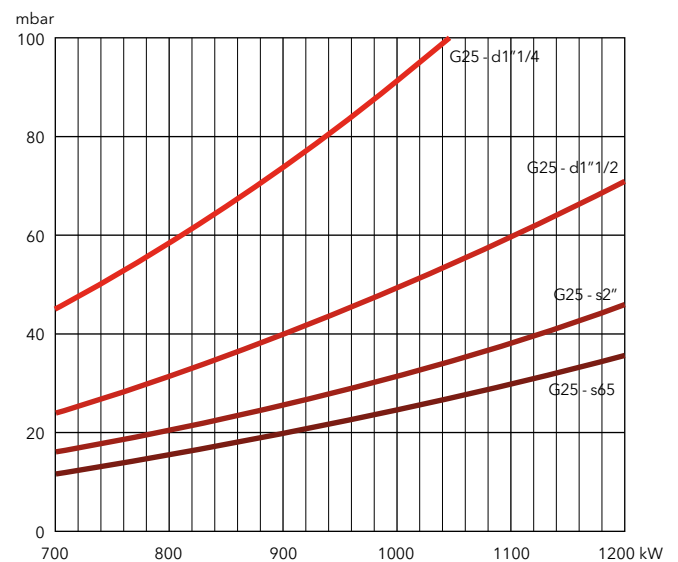

LPG

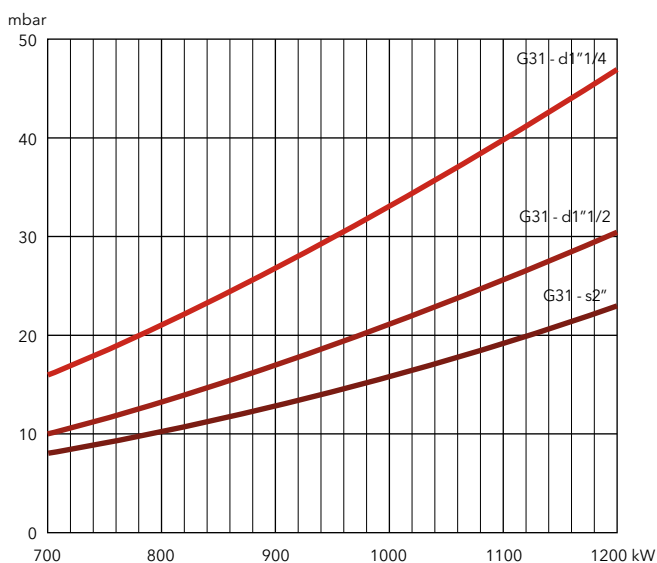

VG6.1600 DP R / VG6.2100 DP R

200 ... 2300 kW
2 stage progressive/modulating pneumatic



- **Fuels:** natural gas (G20/G25, $H_u = 8,83...10,35 \text{ kWh/m}^3$); LPG (G31, $H_u = 25,89 \text{ kWh/m}^3$)
- **Emissions:** NOx < 120 mg/kWh (NCV), Low NOx class 2 burners according to EN676
- **Operation:** two stage progressive or modulating with the installation of a power regulator and dedicated probes (see page 198)
- **Protection level:** IP 21

TECHNICAL DATA

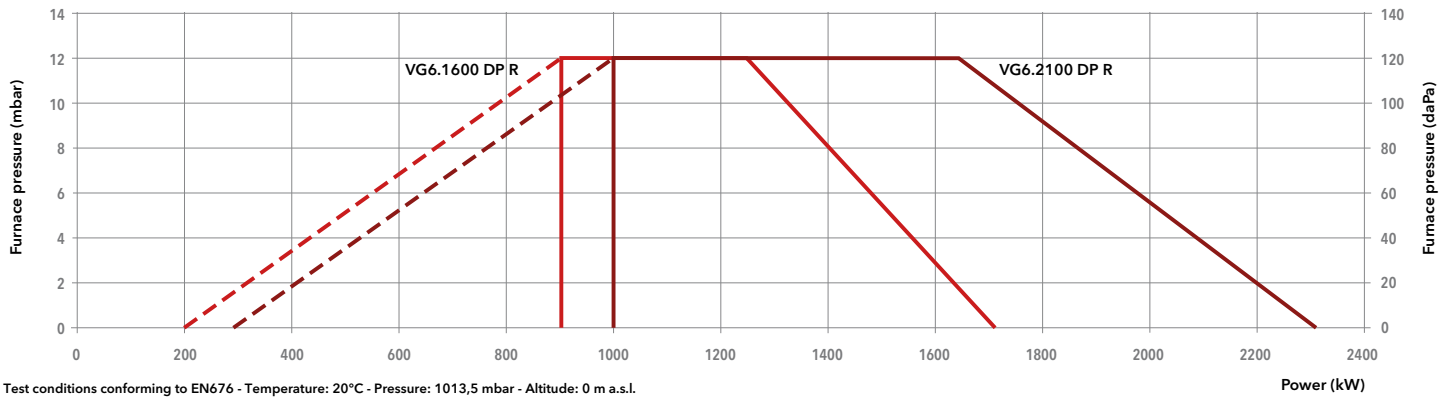

| Model | VG6.1600 DP R /TC | | | VG6.2100 DP R /TC | | | |
|-------------------------------|----------------------------|---------|---------|----------------------------|---------|---------|---------|
| Operation range | (200) 900 - 1700 kW | | | (300) 1000- 2300 kW | | | |
| Gas pressure | 20 - 500 mbar | | | 20 - 500 mbar | | | |
| Control box / flame detection | TCG 5.. / IRD 1020.1 | | | TCG 5.. / IRD 1020.1 | | | |
| Fan motor | 230/400 V - 50 Hz - 2,2 kW | | | 230/400 V - 50 Hz - 2,5 kW | | | |
| Electrical consumption | 100 + 2500 W | | | 100 + 3500 W | | | |
| Acoustic level (LpA) | 77 dB(A) | | | 79 dB(A) | | | |
| CE certificate | 0085 CQ 0570 | | | 0085 CQ 0570 | | | |
| Head length | KN | KL | KM | KN | KL | KM | |
| Complete burner code | VGD 40-080 s80-DN80/TC | - | - | - | 3835911 | 3835910 | 3835909 |
| | VGD 40-065 s65-DN65/TC | 3834801 | 3834802 | 3834803 | 3834813 | 3834814 | 3834815 |
| | VGD 20-5011 s2"-Rp2"/TC | 3834804 | 3834805 | 3834806 | 3834816 | 3834817 | 3834818 |
| | MB-VEF 420 d1"1/2-Rp2"/TC | 3834807 | 3834808 | 3834809 | 3834819 | 3834820 | 3834821 |
| | MB-VEF 412 d1"1/4-Rp2"/TC | 3834810 | 3834811 | 3834812 | 3834822 | 3834823 | 3834824 |

OTHER AVAILABLE VERSIONS

- 60 60 Hz version
- Vent Versions for continuous ventilation and post-ventilation

SCOPE OF SUPPLY

- The burner is delivered in its package complete with:
- 1 burner head with flange seal and securing screws
 - 1 compact gas train with gas filter; the gas filter is built-in for threaded valves (up to 2") and separated for flanged ones (DN65/80/100)
 - 1 bag containing installation fittings
 - 1 bag containing technical documentation (instruction manual, technical data, electrical diagram, exploded view and spare parts list)

DIMENSIONS (mm)

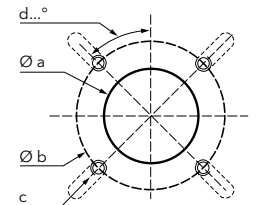
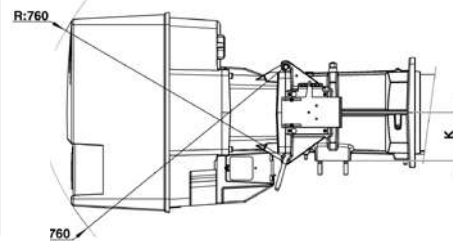
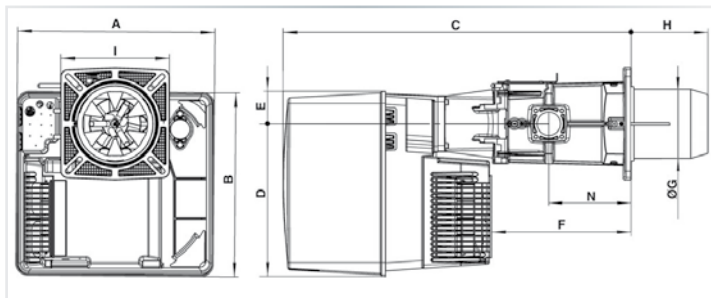

| A | B | C | D | E | F | ØG | H | | | I | K | N |
|-----|-----|------|-----|----|-----|-----|-----|-----|-----|---------|-----|-----|
| | | | | | | | KN | KM | KL | | | |
| 592 | 553 | 1050 | 456 | 97 | 421 | 227 | 270 | 370 | 470 | 326x335 | 144 | 247 |

| Øa (mm) | b (mm) | c | d |
|---------|---------|-----|-----|
| 250 | 300-400 | M12 | 45° |

Gas trains

Gas train "d":

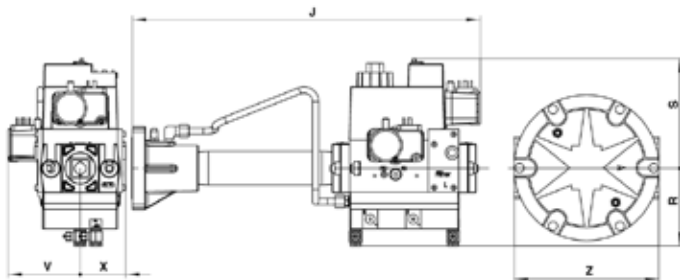

| Model | J | R | S | V | X | Z |
|----------------|-----|-----|-----|----|----|-----|
| d1"1/2-Rp2"/TC | 540 | 123 | 190 | 95 | 55 | - |
| d1"1/4-Rp2"/TC | 450 | 100 | 141 | 95 | 58 | 186 |

Gas train "s":

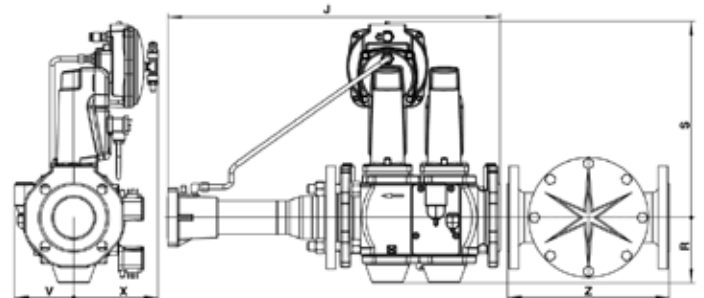

| Model | J | R | S | V | X | Z |
|-------------|-----|-----|-----|-----|-----|-----|
| s80-DN80/TC | 600 | 120 | 350 | 110 | 150 | 320 |
| s65-DN65/TC | 600 | 135 | 360 | 110 | 150 | 290 |
| s2"-Rp2"/TC | 612 | 103 | 330 | 110 | 150 | 186 |

PACKAGING

The burner is delivered on a pallet in three packages containing:

- burner housing
- combustion head
- gas train and filter

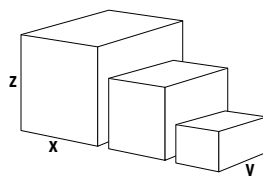

| Component | | Dimensions (mm) | | | Gross weight (kg) |
|-----------------|----------------|-----------------|-----|-----|-------------------|
| | | X | Y | Z | |
| Burner body | VG6.1600 DP R | 800 | 600 | 850 | 67,8 |
| | VG6.2100 DP R | 800 | 600 | 850 | 69,2 |
| Combustion head | KN | 1000 | 380 | 420 | 26,7 |
| | KL | 1100 | 380 | 430 | 29,4 |
| | KM | 1100 | 380 | 430 | 28 |
| Gas train | s80-DN80/TC | 670 | 530 | 380 | 39 |
| | s65-DN65/TC | 670 | 530 | 380 | 29,4 |
| | s2"-Rp2"/TC | 670 | 530 | 380 | 16,5 |
| | d1"1/2-Rp2"/TC | 400 | 570 | 200 | 14,3 |
| | d1"1/4-Rp2"/TC | 590 | 390 | 180 | 13 |

VG6.1600 DP R / VG6.2100 DP R

200 ... 2300 kW

2 stage progressive/modulating pneumatic

PRESSURE LOSS [BURNER HEAD + GAS TRAIN] (mbar)

VG6.1600 DP R

| Burner output (kW) | Natural gas G20 Hi = 10,35 kWh/m ³ | | | | Natural gas G25 Hi = 8,83 kWh/m ³ | | | | LPG G31 Hi = 25,89 kWh/m ³ | | | |
|--------------------|---|-------------|----------|----------|--|-------------|----------|----------|---------------------------------------|-------------|----------|----------|
| | d1"1/4-Rp2" | d1"1/2-Rp2" | s2"-Rp2" | s65-DN65 | d1"1/4-Rp2" | d1"1/2-Rp2" | s2"-Rp2" | s65-DN65 | d1"1/4-Rp2" | d1"1/2-Rp2" | s2"-Rp2" | s65-DN65 |
| 800 | 34 | 16 | 8 | 5 | 52 | 24 | 12 | 8 | 16 | 8 | 5 | 4 |
| 1000 | 52 | 24 | 12 | 8 | 78 | 36 | 18 | 12 | 24 | 12 | 8 | 6 |
| 1200 | 76 | 35 | 18 | 11 | 113 | 53 | 27 | 17 | 35 | 18 | 11 | 8 |
| 1400 | 103 | 48 | 24 | 15 | 153 | 71 | 37 | 22 | 47 | 24 | 15 | 11 |
| 1600 | 135 | 62 | 32 | 20 | 202 | 93 | 48 | 29 | 62 | 32 | 19 | 14 |

Natural gas G20

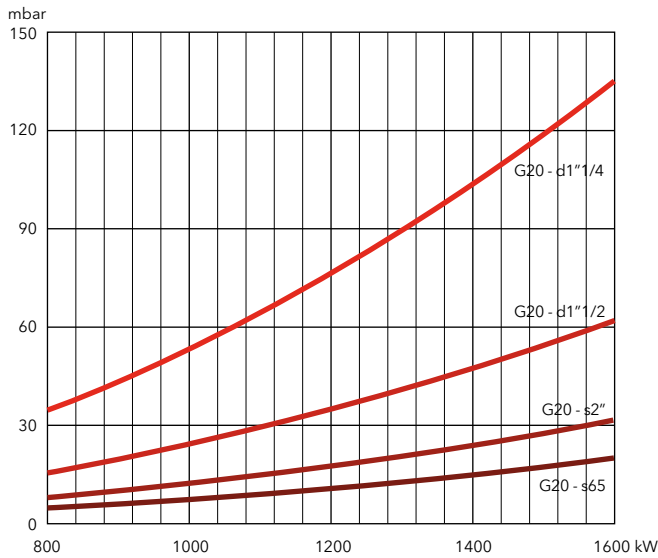

Natural gas G25

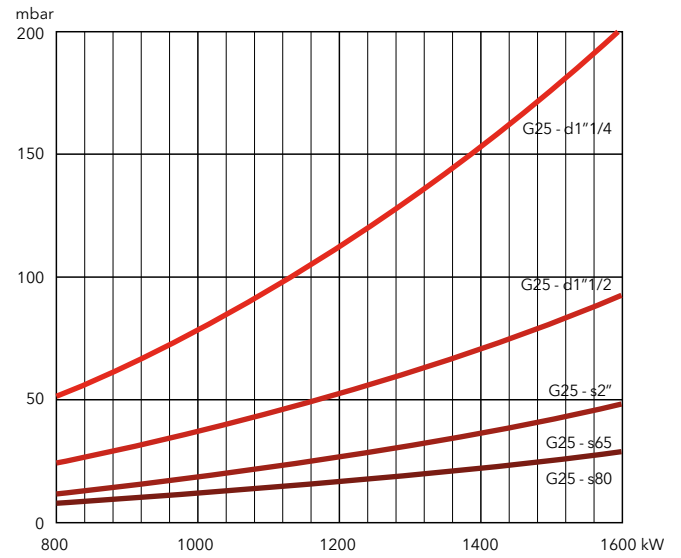

LPG

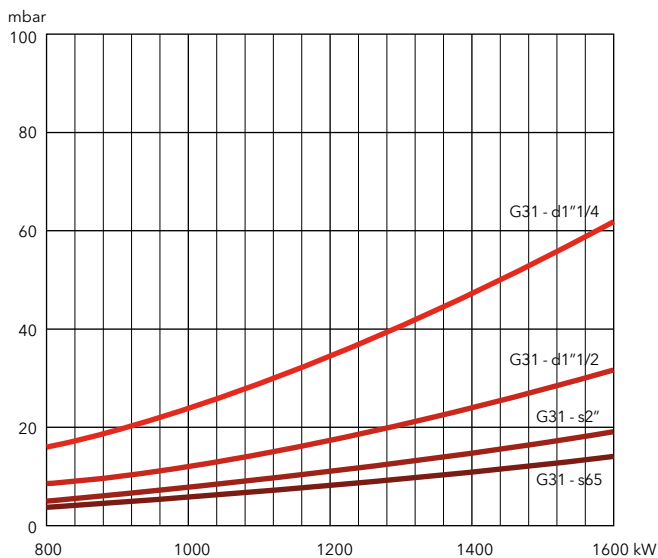



PRESSURE LOSS [BURNER HEAD + GAS TRAIN] (mbar)

VG6.2100 DP R

| Burner output (kW) | Natural gas G20 Hi = 10,35 kWh/m ³ | | | | | Natural gas G25 Hi = 8,83 kWh/m ³ | | | | | LPG G31 Hi = 25,89 kWh/m ³ | | |
|--------------------|---|-----------------|--------------|--------------|--------------|--|-----------------|--------------|--------------|--------------|---------------------------------------|-----------------|--------------|
| | d1"1/4- Rp2" | d1"1/2- Rp2" | s2"- Rp2" | s65- DN65 | s80- DN80 | d1"1/4- Rp2" | d1"1/2- Rp2" | s2"- Rp2" | s65- DN65 | s80- DN80 | d1"1/4- Rp2" | d1"1/2- Rp2" | s2"- Rp2" |
| 1300 | 87 | 39 | 19 | 10 | 7 | 130 | 58 | 28 | 16 | 10 | 38 | 18 | 10 |
| 1500 | 114 | 51 | 25 | 14 | 9 | 170 | 76 | 37 | 21 | 13 | 50 | 24 | 13 |
| 1700 | 147 | 66 | 32 | 18 | 11 | 220 | 98 | 48 | 27 | 17 | 65 | 31 | 17 |
| 1900 | 184 | 83 | 40 | 22 | 14 | 274 | 123 | 60 | 34 | 21 | 81 | 38 | 21 |
| 2100 | 225 | 101 | 49 | 27 | 17 | 336 | 151 | 73 | 41 | 26 | 99 | 47 | 26 |
| 2300 | 269 | 121 | 58 | 33 | 21 | 402 | 180 | 87 | 49 | 31 | 119 | 56 | 30 |

Natural gas G20

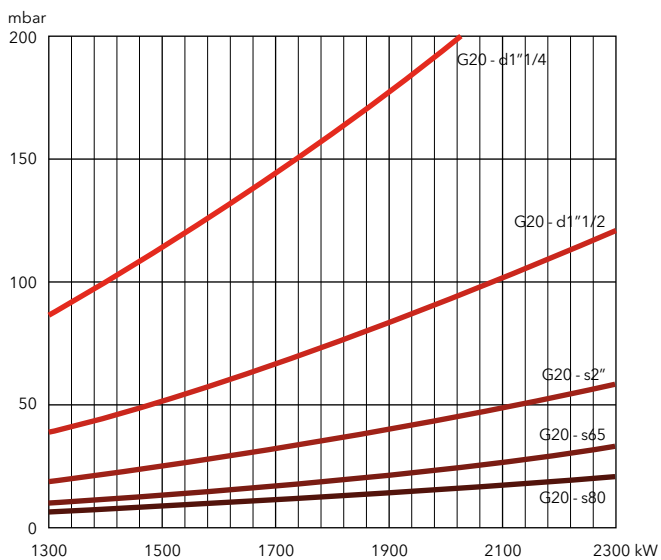

Natural gas G25

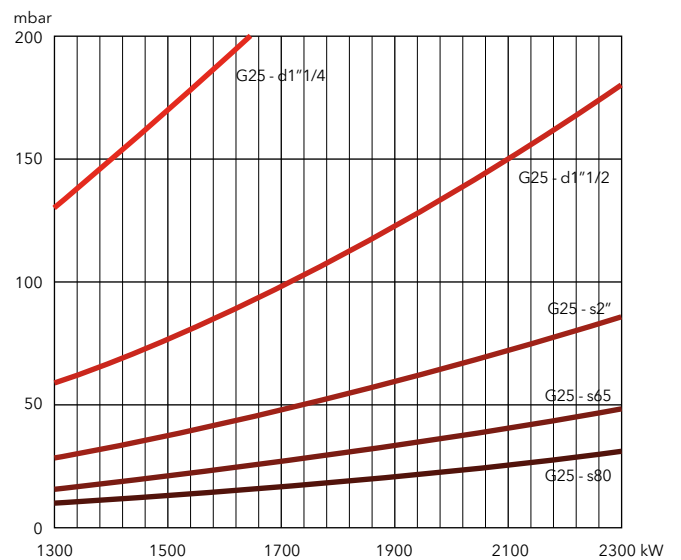

LPG

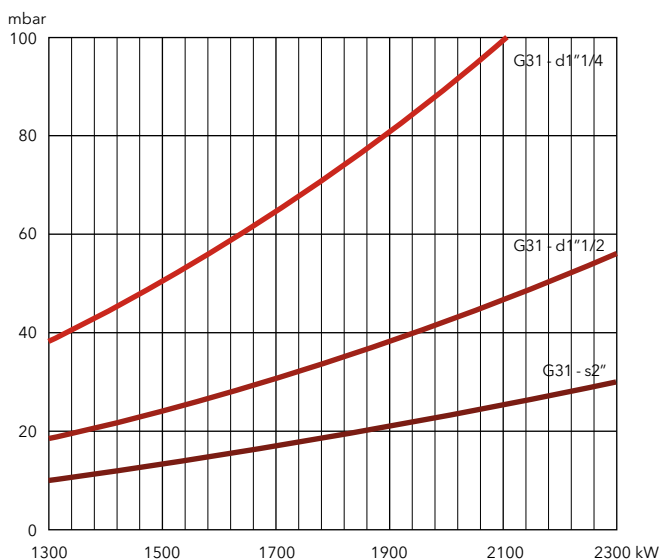

VG5.950 M R / VG5.1200 M R

150 ... 1200 kW

Two stage progressive/modulating electronic

- **Fuels:** natural gas (G20/G25, $H_u = 8,83...10,35 \text{ kWh/m}^3$); LPG (G31, $H_u = 25,89 \text{ kWh/m}^3$)
- **Emissions:** $\text{NO}_x < 120 \text{ mg/kWh}$ (NCV), Low NO_x class 2 burners according to EN676
- **Operation:** two stage progressive or modulating with the installation of a power regulator and dedicated probes (see page 198)
- **Protection level:** IP 21



TECHNICAL DATA

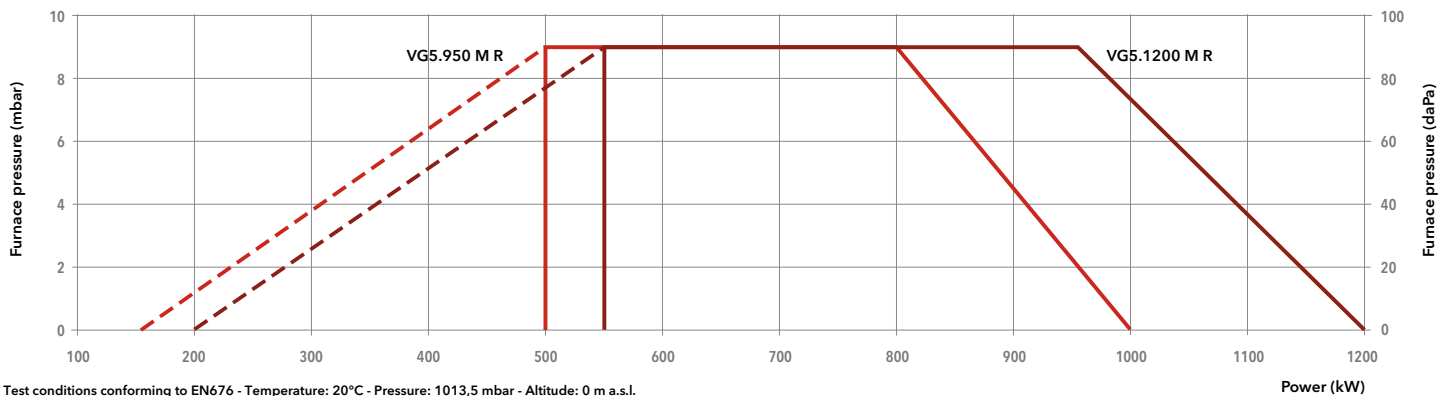

Test conditions conforming to EN676 - Temperature: 20°C - Pressure: 1013,5 mbar - Altitude: 0 m a.s.l.

| Model | VG5.950 M R /TC | | | VG5.1200 M R /TC | | | | |
|-------------------------------|----------------------------|------------------|---------|----------------------------|---------|---------|---------|---------|
| Operation range | (150) 500 - 1000 kW | | | (200) 550 - 1200 kW | | | | |
| Gas pressure | 50 - 500 mbar | | | 50 - 500 mbar | | | | |
| Control box / flame detection | BT3... / ionization | | | BT3... / ionization | | | | |
| Fan motor | 230/400 V - 50 Hz - 1,5 kW | | | 230/400 V - 50 Hz - 1,5 kW | | | | |
| Electrical consumption | 100 + 2200 W | | | 100 + 2300 W | | | | |
| Acoustic level (LpA) | 77 dB(A) | | | 77 dB(A) | | | | |
| CE certificate | 0085 CQ 0570 | | | 0085 CQ 0570 | | | | |
| Head length | | KN | KL | KM | KN | KL | KM | |
| Complete burner code | VGD 40-065 | s65-DN65/TC | 3835413 | 3835414 | 3835415 | 3835428 | 3835429 | 3835430 |
| | MBC1900 | d65-DN65/TC | 3835416 | 3835417 | 3835418 | 3835431 | 3835432 | 3835433 |
| | MBC1200 | d2"-Rp2"/TC | 3835419 | 3835420 | 3835421 | 3835434 | 3835435 | 3835436 |
| | MBC700 | d1"1/2-Rp2"/TC | 3835422 | 3835423 | 3835424 | 3835437 | 3835438 | 3835439 |
| | MBC300 | d3/4"-Rp1"1/4/TC | 3835425 | 3835426 | 3835427 | 3835440 | 3835441 | 3835442 |

OTHER AVAILABLE VERSIONS

- Vent** Versions for continuous ventilation and post-ventilation
- PED** PED version for continuous operation

SCOPE OF SUPPLY

The burner is delivered in its package complete with:

- 1 burner head with flange seal and securing screws
- 1 compact gas train with gas filter; the gas filter is built-in for threaded valves (up to 2") and separated for flanged ones (DN65/80/100)
- 1 bag containing installation fittings
- 1 bag containing technical documentation (instruction manual, technical data, electrical diagram, exploded view and spare parts list)

DIMENSIONS (mm)

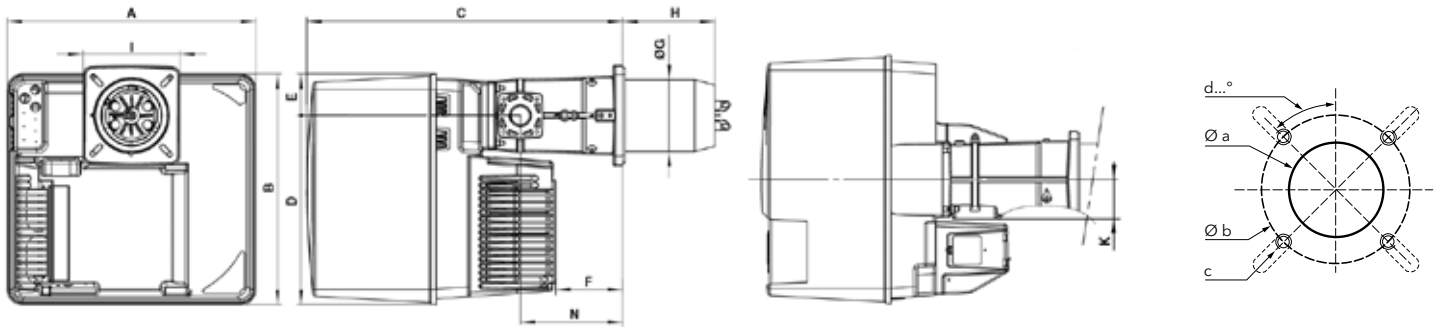

| A | B | C | D | E | F | ØG | H | | | I | K | N |
|-----|-----|-----|-----|----|-----|-----|-----|-----|-----|---------|----|-----|
| | | | | | | | KN | KM | KL | | | |
| 581 | 549 | 752 | 450 | 99 | 164 | 170 | 215 | 325 | 435 | 230x238 | 89 | 244 |

| Øa (mm) | b (mm) | c | d |
|---------|---------|-----|-----|
| 195 | 220-260 | M10 | 45° |

Gas trains

Gas train "d":

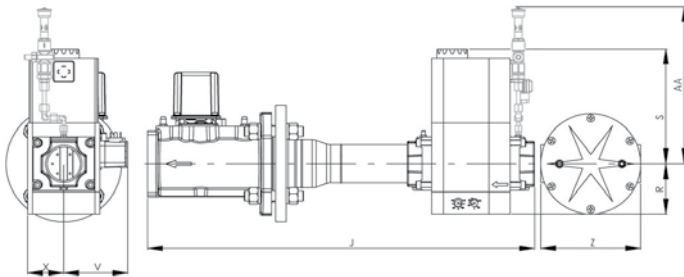

| Model | J | R | S | V | X | Z | AA* |
|---------------|-----|-----|-----|-----|----|-----|-----|
| d65-DN65 | 490 | 183 | 245 | 110 | 98 | 290 | 385 |
| d2"-Rp2" | 700 | 96 | 330 | 125 | 81 | - | 385 |
| d1"1/2-Rp2" | 622 | 80 | 185 | 102 | 57 | - | 320 |
| d3/4"-Rp1"1/4 | 460 | 60 | 173 | 88 | 58 | - | 320 |

Gas train "s":

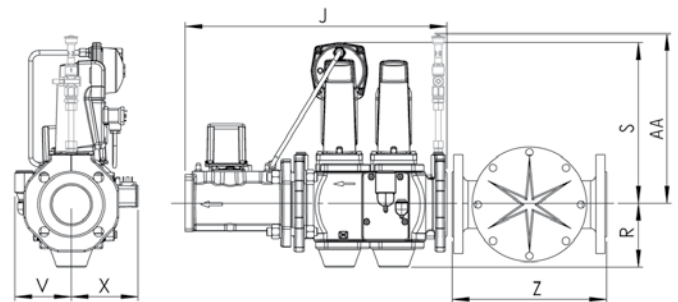

| Model | J | R | S | V | X | Z | AA* |
|----------|-----|-----|-----|-----|-----|-----|-----|
| s65-DN65 | 490 | 118 | 300 | 106 | 126 | 290 | 365 |

*: for PED configuration

PACKAGING

The burner is delivered on a pallet in three packages containing:

- burner housing
- combustion head
- gas train and filter

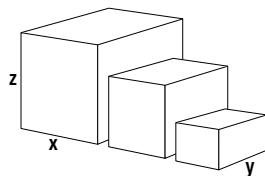

| Component | | Dimensions (mm) | | | Gross weight (kg) |
|-----------------|------------------|-----------------|-----|-----|-------------------|
| | | X | Y | Z | |
| Burner body | VG5.950 M R | 800 | 600 | 850 | 53 |
| | VG5.1200 M R | 800 | 600 | 850 | 54 |
| Combustion head | KN | 780 | 265 | 280 | 12,3 |
| | KL | 1010 | 265 | 280 | 14,4 |
| | KM | 1010 | 265 | 280 | 13,4 |
| Gas train | s65-DN65/TC | 670 | 550 | 380 | 29 |
| | d65-DN65/TC | 670 | 550 | 380 | 17,2 |
| | d2"-Rp2"/TC | 670 | 550 | 380 | 12 |
| | d1"1/2-Rp2"/TC | 670 | 550 | 380 | 12 |
| | d3/4"-Rp1"1/4/TC | 590 | 390 | 180 | 7 |

VG5.950 M R / VG5.1200 M R

150 ... 1200 kW

Two stage progressive/modulating electronic

PRESSURE LOSS [BURNER HEAD + GAS TRAIN] (mbar)

VG5.950 M R

| Burner output (kW) | Natural gas G20 Hi = 10,35 kWh/m ³ | | | | | Natural gas G25 Hi = 8,83 kWh/m ³ | | | | | LPG G31 | |
|--------------------|---|-------------|----------|----------|----------|--|-------------|----------|----------|----------|-------------|--------------|
| | d3/4-Rp1"1/4 | d1"1/2-Rp2" | d2"-Rp2" | d65-DN65 | s65-DN65 | d3/4-Rp1"1/4 | d1"1/2-Rp2" | d2"-Rp2" | d65-DN65 | s65-DN65 | d1"1/2-Rp2" | d3/4-Rp1"1/4 |
| 500 | 31 | 10 | 7 | 6 | 6 | 46 | 15 | 11 | 9 | 9 | 17 | 8 |
| 600 | 45 | 15 | 9 | 9 | 9 | 67 | 22 | 16 | 12 | 13 | 24 | 11 |
| 700 | 61 | 20 | 13 | 12 | 12 | 91 | 30 | 22 | 17 | 18 | 32 | 15 |
| 800 | 79 | 26 | 17 | 15 | 15 | 118 | 39 | 28 | 22 | 23 | 42 | 20 |
| 900 | 124 | 33 | 21 | 19 | 19 | 149 | 49 | 35 | 28 | 29 | 53 | 25 |
| 1000 | - | 40 | 26 | 24 | 24 | 185 | 60 | 43 | 34 | 36 | 66 | 31 |

Natural gas G20

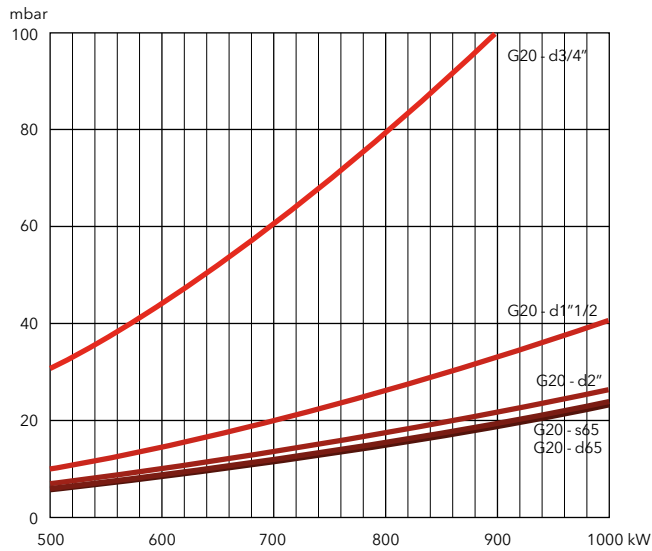

Natural gas G25

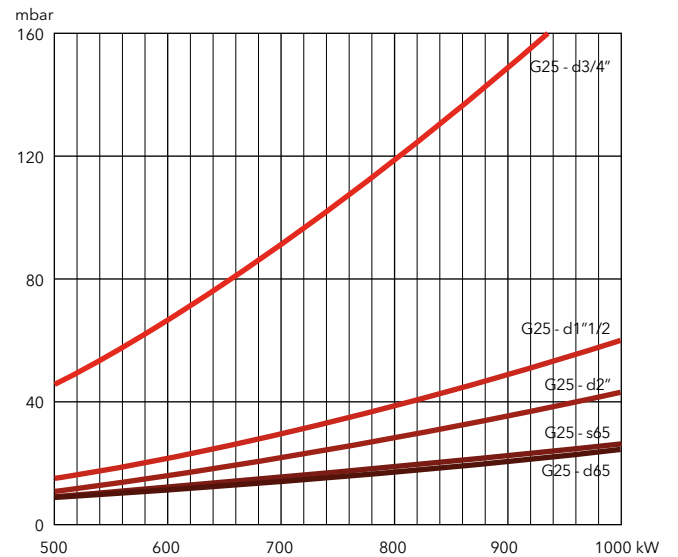

LPG

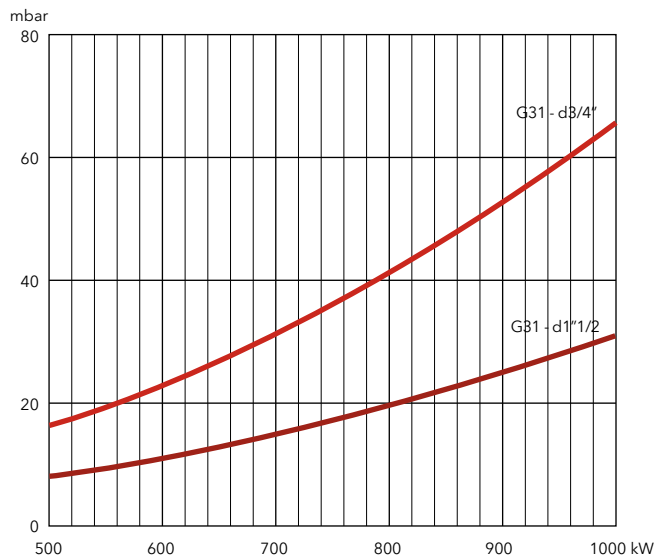



PRESSURE LOSS [BURNER HEAD + GAS TRAIN] (mbar)

VG5.1200 M R

| Burner output (kW) | Natural gas G20 Hi = 10,35 kWh/m ³ | | | | | Natural gas G25 Hi = 8,83 kWh/m ³ | | | | | LPG G31 |
|--------------------|---|-------------|----------|----------|----------|--|-------------|----------|----------|----------|-------------|
| | d3/4-Rp1"1/4 | d1"1/2-Rp2" | d2"-Rp2" | d65-DN65 | s65-DN65 | d3/4-Rp1"1/4 | d1"1/2-Rp2" | d2"-Rp2" | d65-DN65 | s65-DN65 | d1"1/2-Rp2" |
| 700 | 58 | 17 | 10 | 8 | 9 | 86 | 25 | 14 | 12 | 13 | 10 |
| 800 | 75 | 22 | 13 | 10 | 11 | 112 | 32 | 19 | 16 | 17 | 14 |
| 900 | 95 | 27 | 16 | 13 | 14 | 142 | 41 | 24 | 20 | 21 | 17 |
| 1000 | 117 | 34 | 20 | 16 | 17 | 175 | 51 | 29 | 24 | 26 | 21 |
| 1100 | 142 | 41 | 24 | 20 | 21 | 213 | 62 | 36 | 30 | 32 | 26 |
| 1200 | 169 | 49 | 28 | 24 | 25 | 252 | 73 | 42 | 35 | 37 | 31 |

Natural gas G20

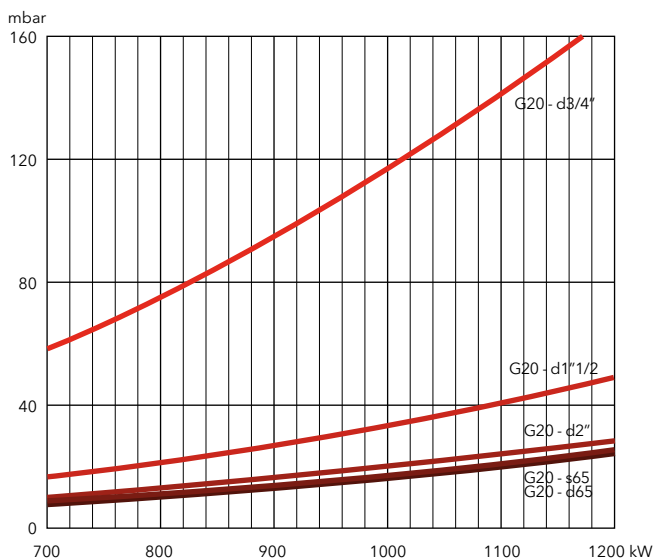

Natural gas G25

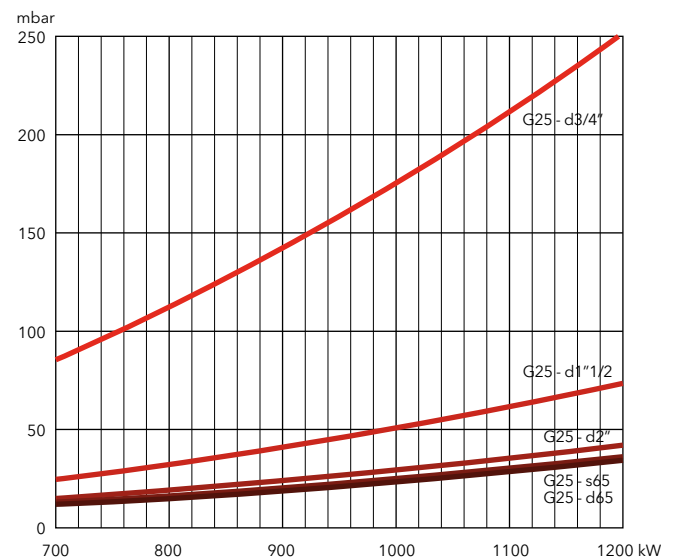

LPG

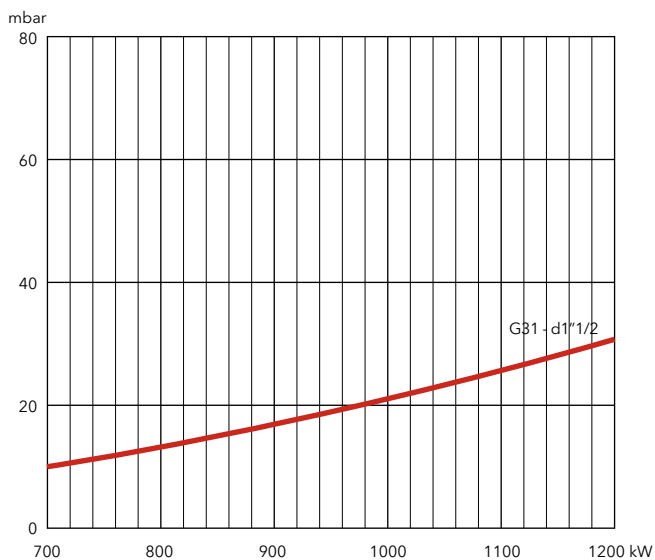

VG6.1600 M R / VG6.2100 M R

200 ... 2300 kW

Two stage progressive/modulating electronic



- **Fuels:** natural gas (G20/G25, $H_u = 8,83...10,35 \text{ kWh/m}^3$); LPG (G31, $H_u = 25,89 \text{ kWh/m}^3$)
- **Emissions:** $\text{NO}_x < 120 \text{ mg/kWh}$ (NCV), Low NO_x class 2 burners according to EN676
- **Operation:** two stage progressive or modulating with the installation of a power regulator and dedicated probes (see page 198)
- **Protection level:** IP 21

TECHNICAL DATA

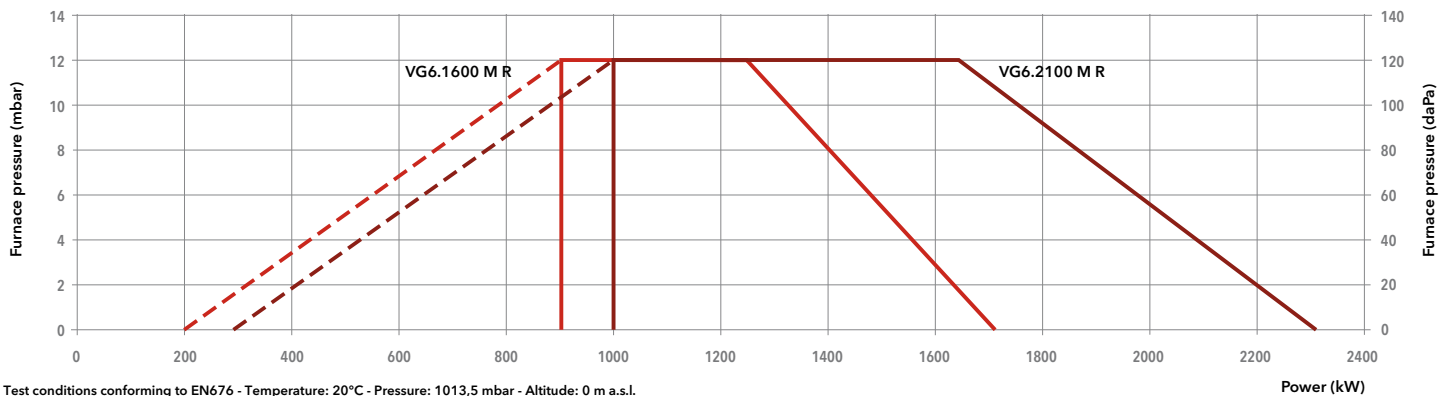

| Model | VG6.1600 M R /TC | | | VG6.2100 M R /TC | | | |
|-------------------------------|----------------------------|---------|---------|----------------------------|---------|---------|---------|
| Operation range | (200) 900 - 1700 kW | | | (300) 1000- 2300 kW | | | |
| Gas pressure | 50 - 500 mbar | | | 50 - 500 mbar | | | |
| Control box / flame detection | BT3... / IRD 1020.1 | | | BT3... / IRD 1020.1 | | | |
| Fan motor | 230/400 V - 50 Hz - 2,2 kW | | | 230/400 V - 50 Hz - 2,5 kW | | | |
| Electrical consumption | 100 + 2500 W | | | 100 + 3500 W | | | |
| Acoustic level (LpA) | 77 dB(A) | | | 79 dB(A) | | | |
| CE certificate | 0085 CQ 0570 | | | 0085 CQ 0570 | | | |
| Head length | KN | KL | KM | KN | KL | KM | |
| Complete | VGD 40-065 s65-DN65/TC | 3834834 | 3834835 | 3834836 | 3834846 | 3834847 | 3834848 |
| burner code | MBC1900 d65-DN65/TC | 3834831 | 3834832 | 3834833 | 3834843 | 3834844 | 3834845 |
| | MBC1200 d2"-Rp2"/TC | 3834828 | 3834829 | 3834830 | 3834840 | 3834841 | 3834842 |
| | MBC700 d1"1/2-Rp2"/TC | 3834825 | 3834826 | 3834827 | 3834837 | 3834838 | 3834839 |

OTHER AVAILABLE VERSIONS

- Vent** Versions for continuous ventilation and post-ventilation
- PED** PED version for continuous operation

SCOPE OF SUPPLY

The burner is delivered in its package complete with:

- 1 burner head with flange seal and securing screws
- 1 compact gas train with gas filter; the gas filter is built-in for threaded valves (up to 2") and separated for flanged ones (DN65/80/100)
- 1 bag containing installation fittings
- 1 bag containing technical documentation (instruction manual, technical data, electrical diagram, exploded view and spare parts list)



DIMENSIONS (mm)

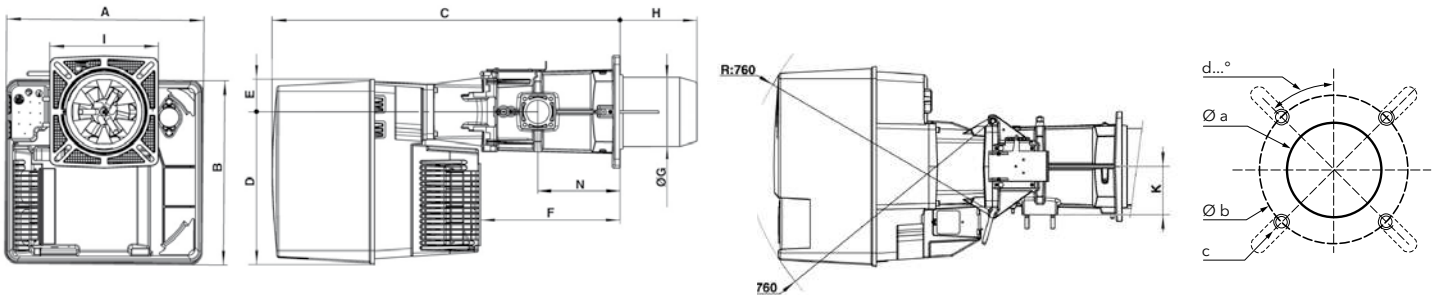

| A | B | C | D | E | F | ØG | H | | | I | K | N |
|-----|-----|------|-----|----|-----|-----|-----|-----|-----|---------|-----|-----|
| | | | | | | | KN | KM | KL | | | |
| 592 | 553 | 1050 | 456 | 97 | 421 | 227 | 270 | 370 | 470 | 326x335 | 144 | 247 |

| Øa (mm) | b (mm) | c | d |
|---------|---------|-----|-----|
| 250 | 300-400 | M12 | 45° |

Gas trains

Gas train "d":

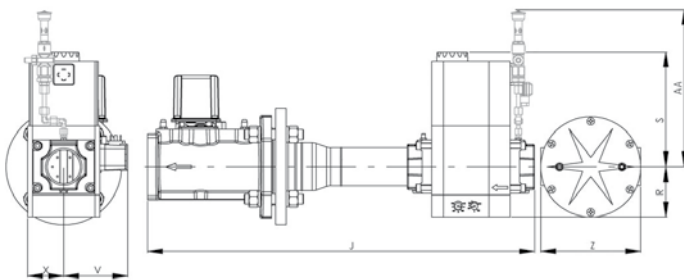

| Model | J | R | S | V | X | Z | AA* |
|-------------|-----|-----|-----|-----|----|-----|-----|
| d65-DN65 | 490 | 183 | 245 | 110 | 98 | 290 | 385 |
| d2"-Rp2" | 700 | 96 | 330 | 125 | 81 | - | 385 |
| d1"1/2-Rp2" | 622 | 80 | 185 | 102 | 57 | - | 320 |

Gas train "s":

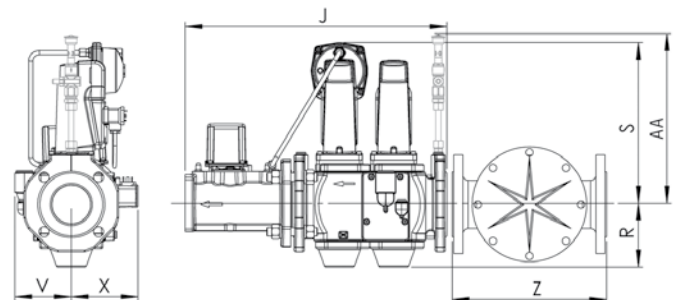

| Model | J | R | S | V | X | Z | AA* |
|----------|-----|-----|-----|-----|-----|-----|-----|
| s65-DN65 | 490 | 118 | 300 | 106 | 126 | 290 | 365 |

*: for PED configuration

PACKAGING

The burner is delivered on a pallet in three packages containing:

- burner housing
- combustion head
- gas train and filter

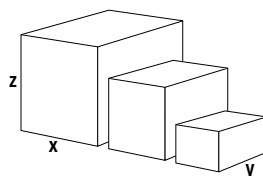

| Component | | Dimensions (mm) | | | Gross weight (kg) |
|-----------------|----------------|-----------------|-----|-----|-------------------|
| | | X | Y | Z | |
| Burner body | VG6.1600 M R | 800 | 600 | 850 | 67,8 |
| | VG6.2100 M R | 800 | 600 | 850 | 69,2 |
| Combustion head | KN | 1000 | 380 | 420 | 26,7 |
| | KL | 1100 | 380 | 430 | 29,4 |
| | KM | 1100 | 380 | 430 | 28 |
| Gas train | s65-DN65/TC | 670 | 550 | 380 | 29,4 |
| | d65-DN65/TC | 670 | 550 | 380 | 33 |
| | d2"-Rp2"/TC | 670 | 550 | 380 | 16,5 |
| | d1"1/2-Rp2"/TC | 670 | 550 | 380 | 14,3 |

VG6.1600 M R / VG6.2100 M R

200 ... 2300 kW

Two stage progressive/modulating electronic

PRESSURE LOSS [BURNER HEAD + GAS TRAIN] (mbar)

VG6.1600 M R

| Burner output (kW) | Natural gas G20 Hi = 10,35 kWh/m ³ | | | | Natural gas G25 Hi = 8,83 kWh/m ³ | | | | LPG G31 |
|--------------------|---|----------|----------|----------|--|----------|----------|----------|-------------|
| | d1"1/2-Rp2" | d2"-Rp2" | d65-DN65 | s65-DN65 | d1"1/2-Rp2" | d2"-Rp2" | d65-DN65 | s65-DN65 | d1"1/2-Rp2" |
| 800 | 17 | 7 | 5 | 6 | 25 | 10 | 8 | 9 | 5 |
| 1000 | 25 | 11 | 8 | 9 | 37 | 16 | 11 | 13 | 7 |
| 1200 | 36 | 16 | 11 | 13 | 54 | 23 | 16 | 19 | 10 |
| 1400 | 49 | 21 | 15 | 17 | 73 | 32 | 22 | 25 | 13 |
| 1600 | 64 | 28 | 19 | 22 | 96 | 41 | 29 | 33 | 17 |

Natural gas G20

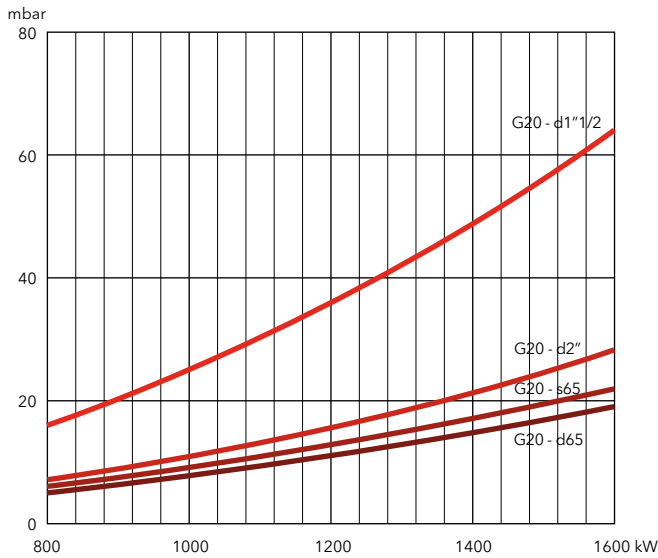

Natural gas G25

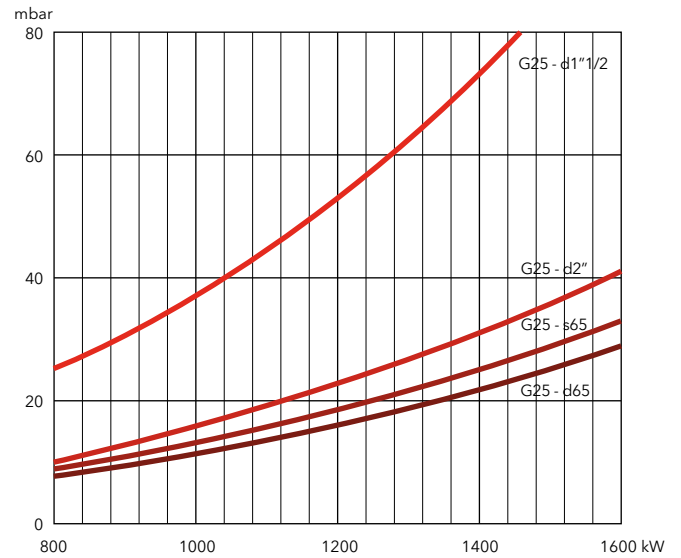

LPG

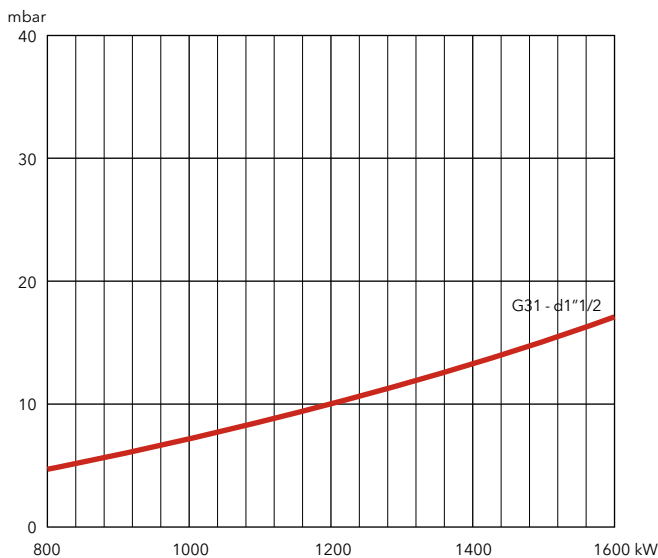



PRESSURE LOSS [BURNER HEAD + GAS TRAIN] (mbar)

VG6.2100 M R

| Burner output (kW) | Natural gas G20 Hi = 10,35 kWh/m ³ | | | | Natural gas G25 Hi = 8,83 kWh/m ³ | | | | LPG G31 Hi = 25,89 kWh/m ³ | |
|--------------------|---|----------|----------|----------|--|----------|----------|----------|---------------------------------------|----------|
| | d1"1/2-Rp2" | d2"-Rp2" | d65-DN65 | s65-DN65 | d1"1/2-Rp2" | d2"-Rp2" | d65-DN65 | s65-DN65 | d1"1/2-Rp2" | d2"-Rp2" |
| 1300 | 40 | 16 | 10 | 12 | 60 | 24 | 15 | 18 | 19 | 9 |
| 1500 | 53 | 21 | 13 | 16 | 78 | 31 | 20 | 24 | 25 | 11 |
| 1700 | 68 | 27 | 17 | 20 | 102 | 40 | 26 | 30 | 32 | 14 |
| 1900 | 85 | 34 | 22 | 26 | 127 | 50 | 32 | 38 | 40 | 18 |
| 2100 | 104 | 41 | 27 | 31 | 156 | 61 | 40 | 46 | 48 | 22 |
| 2300 | 125 | 49 | 32 | 37 | 186 | 73 | 48 | 56 | 58 | 27 |

Natural gas G20

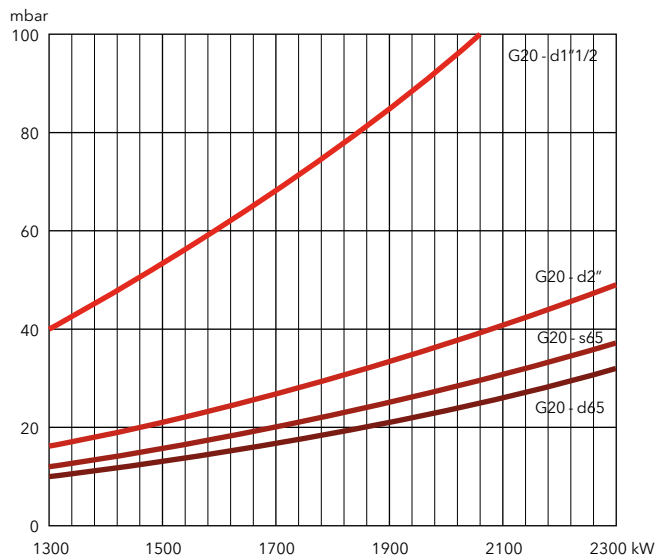

Natural gas G25

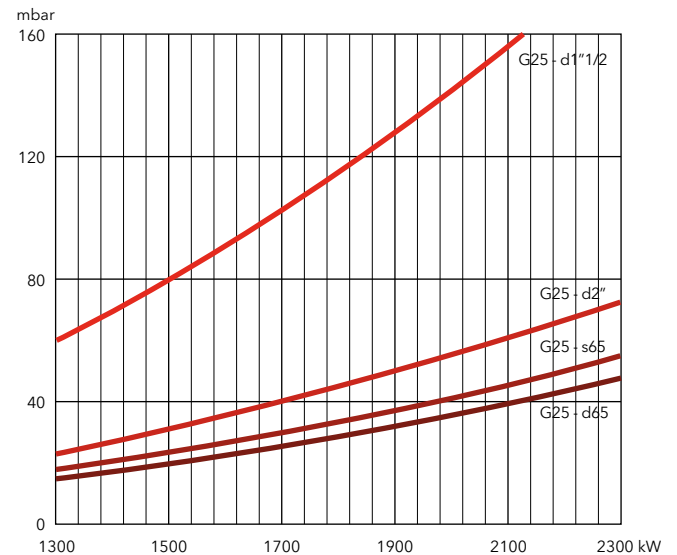

LPG

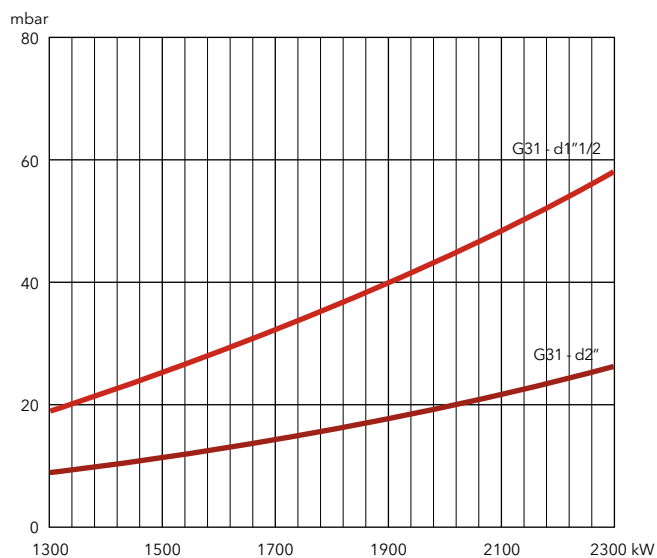

VG5.950 M V R / VG5.1200 M V R

150 ... 1200 kW

Two stage progressive/modulating electronic + fan speed control



- **Fuels:** natural gas (G20/G25, $H_u = 8,83...10,35 \text{ kWh/m}^3$); LPG (G31, $H_u = 25,89 \text{ kWh/m}^3$)
- **Emissions:** $\text{NO}_x < 120 \text{ mg/kWh}$ (NCV), Low NO_x class 2 burners according to EN676
- **Operation:** two stage progressive or modulating with the installation of a power regulator and dedicated probes (see page 198)
- **Protection level:** IP 21

TECHNICAL DATA

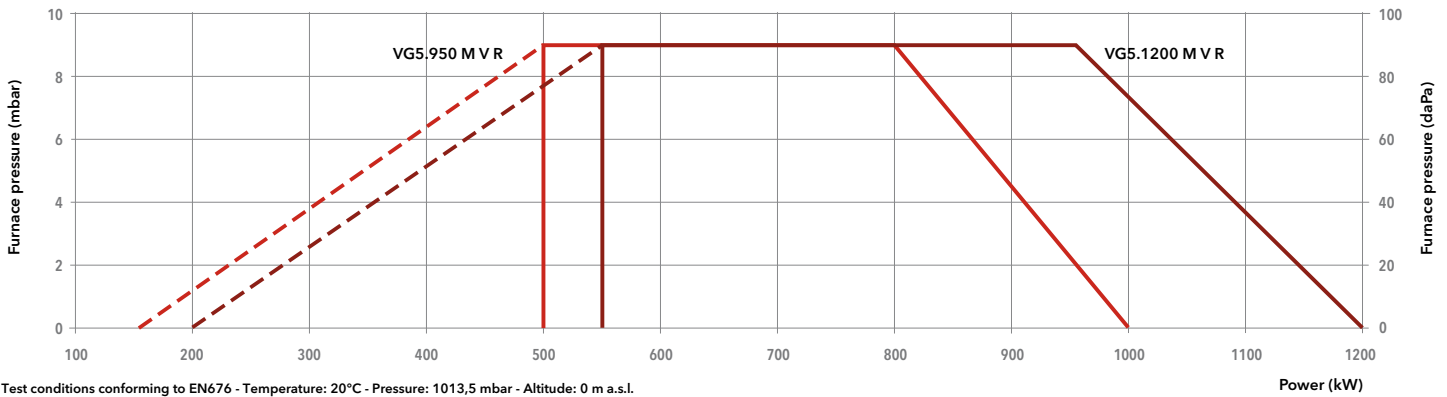

| Model | VG5.950 M V R /TC | | | VG5.1200 M V R /TC | | | | |
|-------------------------------|----------------------------|------------------|---------|----------------------------|---------|---------|---------|---------|
| Operation range | (150) 500 - 1000 kW | | | (200) 550 - 1200 kW | | | | |
| Gas pressure | 50 - 500 mbar | | | 50 - 500 mbar | | | | |
| Control box / flame detection | BT3... / ionization | | | BT3... / ionization | | | | |
| Fan motor | 230/400 V - 50 Hz - 1,5 kW | | | 230/400 V - 50 Hz - 1,5 kW | | | | |
| Electrical consumption | 100 + 2200 W | | | 100 + 2300 W | | | | |
| Acoustic level (LpA) | 77 dB(A) | | | 77 dB(A) | | | | |
| CE certificate | 0085 CQ 0570 | | | 0085 CQ 0570 | | | | |
| Head length | | KN | KL | KM | KN | KL | KM | |
| Complete burner code | VGD 40-065 | s65-DN65/TC | 3835443 | 3835444 | 3835445 | 3835458 | 3835459 | 3835460 |
| | MBC1900 | d65-DN65/TC | 3835446 | 3835447 | 3835448 | 3835461 | 3835462 | 3835463 |
| | MBC1200 | d2"-Rp2"/TC | 3835449 | 3835450 | 3835451 | 3835464 | 3835465 | 3835466 |
| | MBC700 | d1"1/2-Rp2"/TC | 3835452 | 3835453 | 3835454 | 3835467 | 3835468 | 3835469 |
| | MBC300 | d3/4"-Rp1"1/4/TC | 3835455 | 3835456 | 3835457 | 3835470 | 3835471 | 3835472 |

OTHER AVAILABLE VERSIONS

- Vent** Versions for continuous ventilation and post-ventilation
- PED** PED version for continuous operation

SCOPE OF SUPPLY

The burner is delivered in its package complete with:

- 1 burner head with flange seal and securing screws
- 1 compact gas train with gas filter; the gas filter is built-in for threaded valves (up to 2") and separated for flanged ones (DN65/80/100)
- 1 bag containing installation fittings
- 1 bag containing technical documentation (instruction manual, technical data, electrical diagram, exploded view and spare parts list)



DIMENSIONS (mm)

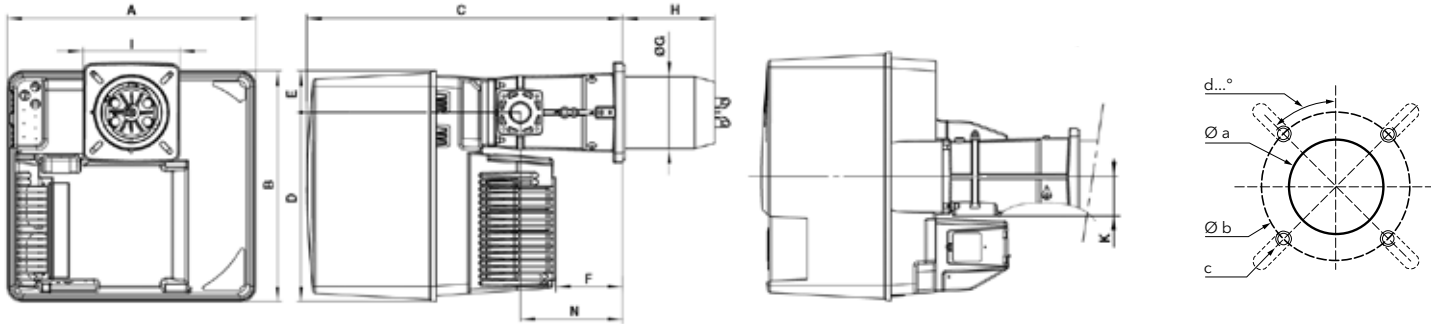

| A | B | C | D | E | F | ØG | H | | | I | K | N |
|-----|-----|-----|-----|----|-----|-----|-----|-----|-----|---------|----|-----|
| | | | | | | | KN | KM | KL | | | |
| 581 | 549 | 752 | 450 | 99 | 164 | 170 | 215 | 325 | 435 | 230x238 | 89 | 244 |

| Øa (mm) | b (mm) | c | d |
|---------|---------|-----|-----|
| 195 | 220-260 | M10 | 45° |

Gas trains

Gas train "d":

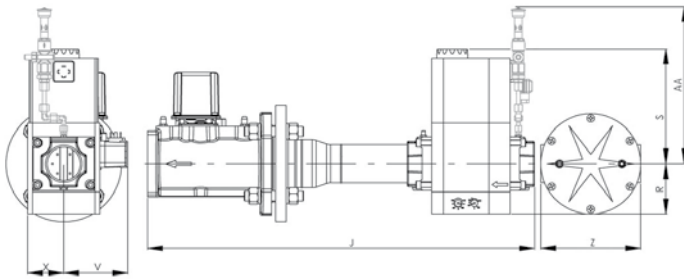

| Model | J | R | S | V | X | Z | AA* |
|---------------|-----|-----|-----|-----|----|-----|-----|
| d65-DN65 | 490 | 183 | 245 | 110 | 98 | 290 | 385 |
| d2"-Rp2" | 700 | 96 | 330 | 125 | 81 | - | 385 |
| d1"1/2-Rp2" | 622 | 80 | 185 | 102 | 57 | - | 320 |
| d3/4"-Rp1"1/4 | 460 | 60 | 173 | 88 | 58 | - | 320 |

Gas train "s":

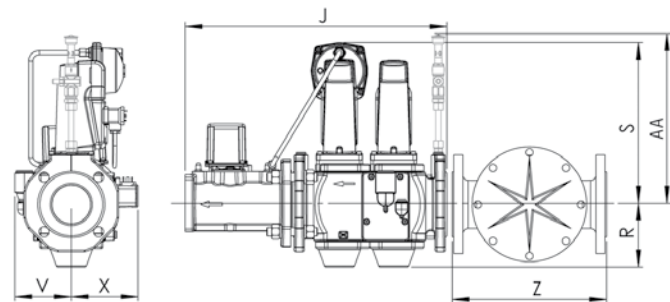

| Model | J | R | S | V | X | Z | AA* |
|----------|-----|-----|-----|-----|-----|-----|-----|
| s65-DN65 | 490 | 118 | 300 | 106 | 126 | 290 | 365 |

*: for PED configuration

PACKAGING

The burner is delivered on a pallet in three packages containing:

- burner housing
- combustion head
- gas train and filter

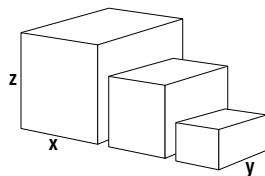

| Component | | Dimensions (mm) | | | Gross weight (kg) |
|-----------------|------------------|-----------------|-----|-----|-------------------|
| | | X | Y | Z | |
| Burner body | VG5.950 M V R | 800 | 600 | 850 | 53 |
| | VG5.1200 M V R | 800 | 600 | 850 | 54 |
| Combustion head | KN | 780 | 265 | 280 | 12,3 |
| | KL | 1010 | 265 | 280 | 14,4 |
| | KM | 1010 | 265 | 280 | 13,4 |
| Gas train | s65-DN65/TC | 670 | 550 | 380 | 29 |
| | d65-DN65/TC | 670 | 550 | 380 | 17,2 |
| | d2"-Rp2"/TC | 670 | 550 | 380 | 12 |
| | d1"1/2-Rp2"/TC | 670 | 550 | 380 | 12 |
| | d3/4"-Rp1"1/4/TC | 590 | 390 | 180 | 7 |

VG5.950 M V R / VG5.1200 M V R

150 ... 1200 kW

Two stage progressive/modulating electronic + fan speed control

PRESSURE LOSS [BURNER HEAD + GAS TRAIN] (mbar)

VG5.950 M V R

| Burner output (kW) | Natural gas G20 Hi = 10,35 kWh/m ³ | | | | | Natural gas G25 Hi = 8,83 kWh/m ³ | | | | | LPG G31 | |
|--------------------|---|-------------|----------|----------|----------|--|-------------|----------|----------|----------|-------------|--------------|
| | d3/4-Rp1"1/4 | d1"1/2-Rp2" | d2"-Rp2" | d65-DN65 | s65-DN65 | d3/4-Rp1"1/4 | d1"1/2-Rp2" | d2"-Rp2" | d65-DN65 | s65-DN65 | d1"1/2-Rp2" | d3/4-Rp1"1/4 |
| 500 | 31 | 10 | 7 | 6 | 6 | 46 | 15 | 11 | 9 | 9 | 17 | 8 |
| 600 | 45 | 15 | 9 | 9 | 9 | 67 | 22 | 16 | 12 | 13 | 24 | 11 |
| 700 | 61 | 20 | 13 | 12 | 12 | 91 | 30 | 22 | 17 | 18 | 32 | 15 |
| 800 | 79 | 26 | 17 | 15 | 15 | 118 | 39 | 28 | 22 | 23 | 42 | 20 |
| 900 | 124 | 33 | 21 | 19 | 19 | 149 | 49 | 35 | 28 | 29 | 53 | 25 |
| 1000 | - | 40 | 26 | 24 | 24 | 185 | 60 | 43 | 34 | 36 | 66 | 31 |

Natural gas G20

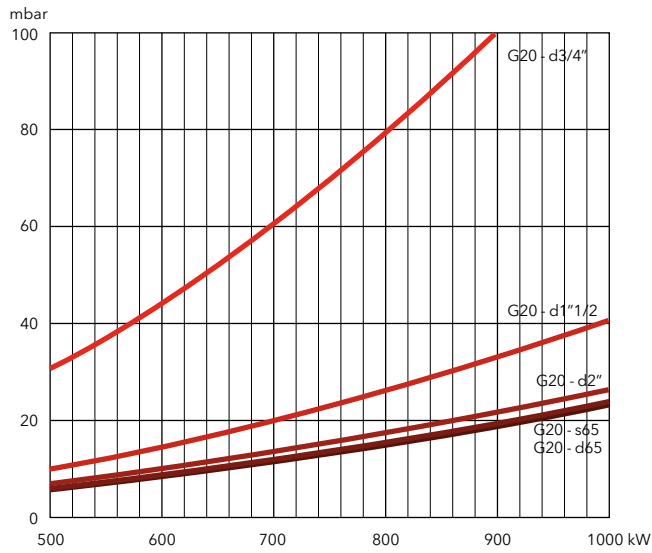

Natural gas G25

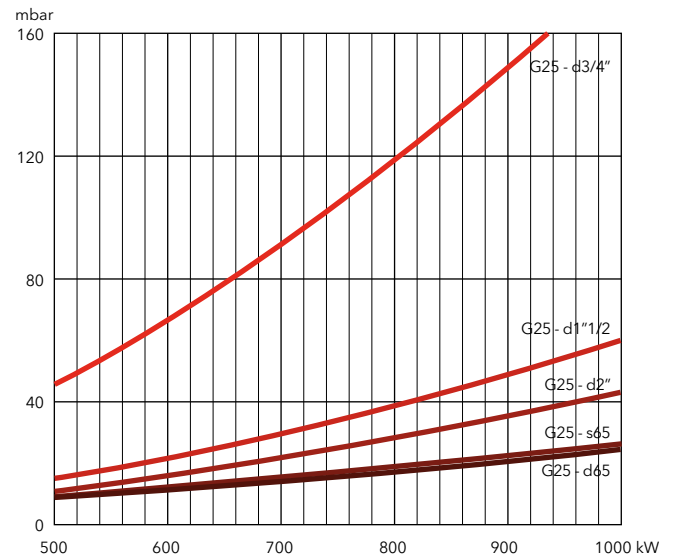

LPG

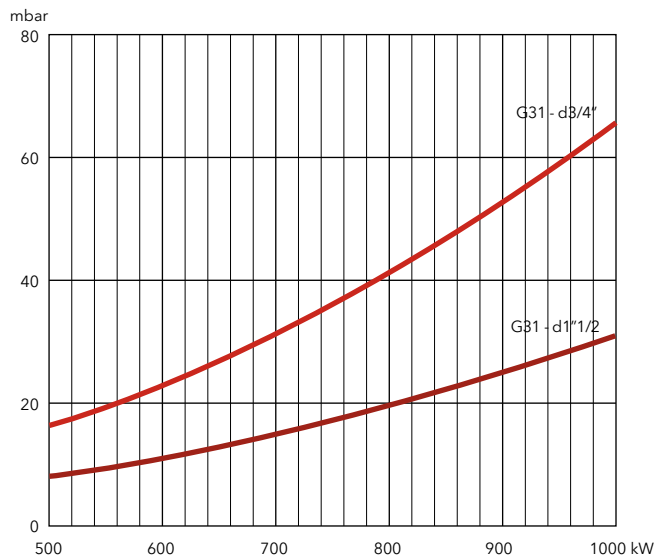



PRESSURE LOSS [BURNER HEAD + GAS TRAIN] (mbar)

VG5.1200 M V R

| Burner output (kW) | Natural gas G20 Hi = 10,35 kWh/m ³ | | | | | Natural gas G25 Hi = 8,83 kWh/m ³ | | | | | LPG G31 |
|--------------------|---|-------------|----------|----------|----------|--|-------------|----------|----------|----------|-------------|
| | d3/4-Rp1"1/4 | d1"1/2-Rp2" | d2"-Rp2" | d65-DN65 | s65-DN65 | d3/4-Rp1"1/4 | d1"1/2-Rp2" | d2"-Rp2" | d65-DN65 | s65-DN65 | d1"1/2-Rp2" |
| 700 | 58 | 17 | 10 | 8 | 9 | 86 | 25 | 14 | 12 | 13 | 10 |
| 800 | 75 | 22 | 13 | 10 | 11 | 112 | 32 | 19 | 16 | 17 | 14 |
| 900 | 95 | 27 | 16 | 13 | 14 | 142 | 41 | 24 | 20 | 21 | 17 |
| 1000 | 117 | 34 | 20 | 16 | 17 | 175 | 51 | 29 | 24 | 26 | 21 |
| 1100 | 142 | 41 | 24 | 20 | 21 | 213 | 62 | 36 | 30 | 32 | 26 |
| 1200 | 169 | 49 | 28 | 24 | 25 | 252 | 73 | 42 | 35 | 37 | 31 |

Natural gas G20

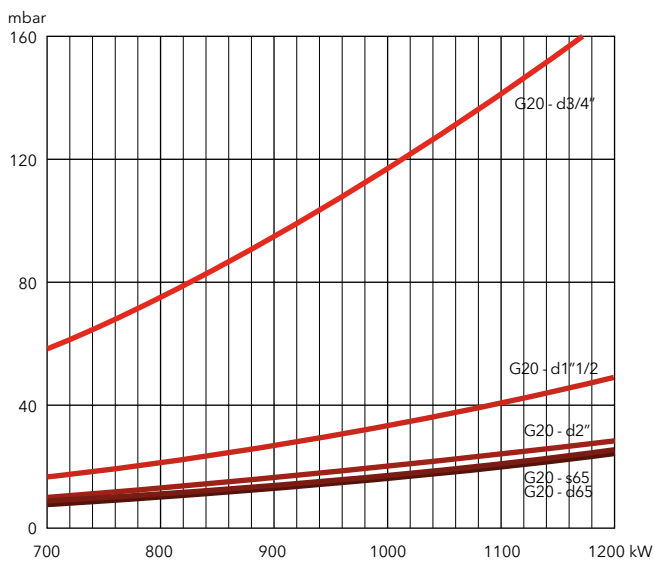

Natural gas G25

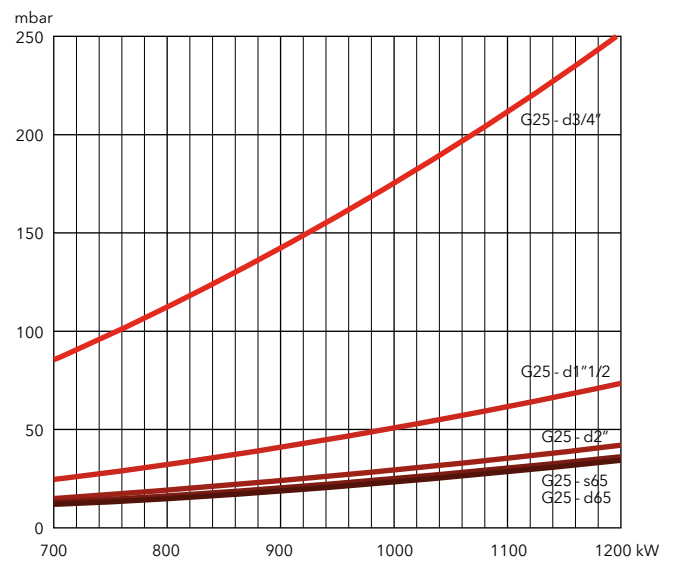

LPG

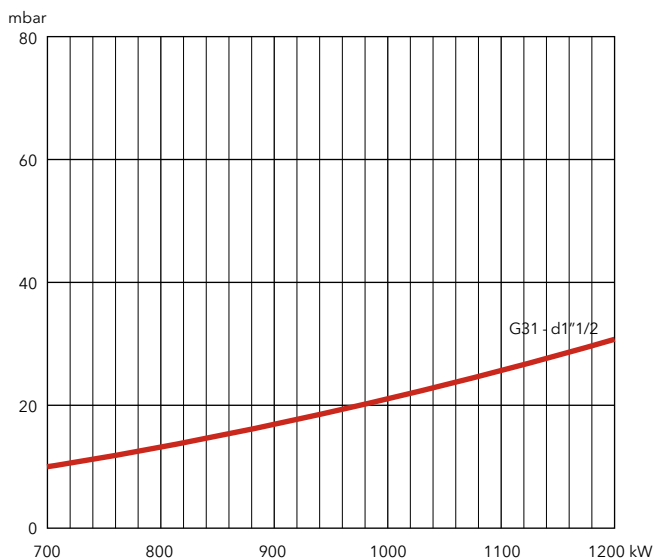

VG6.1600 M V R / VG6.2100 M V R

200 ... 2300 kW

Two stage progressive/modulating electronic + fan speed control



- **Fuels:** natural gas (G20/G25, $H_u = 8,83...10,35 \text{ kWh/m}^3$); LPG (G31, $H_u = 25,89 \text{ kWh/m}^3$)
- **Emissions:** $\text{NO}_x < 120 \text{ mg/kWh}$ (NCV), Low NO_x class 2 burners according to EN676
- **Operation:** two stage progressive or modulating with the installation of a power regulator and dedicated probes (see page 198)
- **Protection level:** IP 21

TECHNICAL DATA

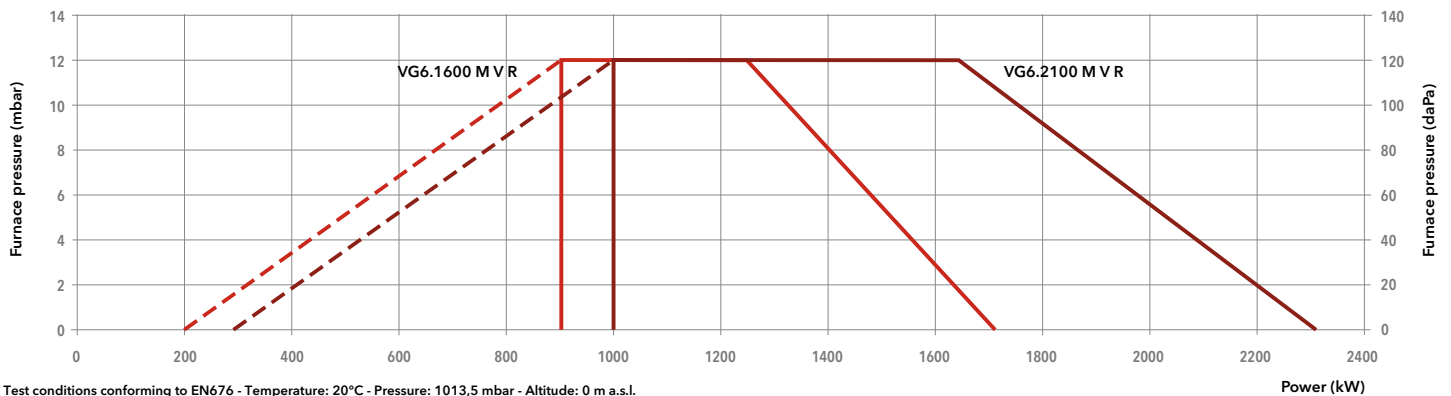

| Model | VG6.1600 M V R /TC | | | VG6.2100 M V R /TC | | | |
|-------------------------------|----------------------------|---------|---------|----------------------------|---------|---------|---------|
| Operation range | (200) 900 - 1700 kW | | | (300) 1000 - 2300 kW | | | |
| Gas pressure | 50 - 500 mbar | | | 50 - 500 mbar | | | |
| Control box / flame detection | BT3... / IRD 1020.1 | | | BT3... / IRD 1020.1 | | | |
| Fan motor | 230/400 V - 50 Hz - 2,2 kW | | | 230/400 V - 50 Hz - 2,5 kW | | | |
| Electrical consumption | 100 + 2500 W | | | 100 + 3500 W | | | |
| Acoustic level (LpA) | 77 dB(A) | | | 79 dB(A) | | | |
| CE certificate | 0085 CQ 0570 | | | 0085 CQ 0570 | | | |
| Head length | KN | KM | KL | KN | KM | KL | |
| Complete | VGD 40-065 s65-DN65/TC | 3835473 | 3835475 | 3835474 | 3835485 | 3835487 | 3835486 |
| burner code | MBC1900 d65-DN65/TC | 3835476 | 3835478 | 3835477 | 3835488 | 3835490 | 3835489 |
| | MBC1200 d2"-Rp2"/TC | 3835479 | 3835481 | 3835480 | 3835491 | 3835493 | 3835492 |
| | MBC700 d1"1/2-Rp2"/TC | 3835482 | 3835484 | 3835483 | 3835494 | 3835496 | 3835495 |

OTHER AVAILABLE VERSIONS

- Vent** Versions for continuous ventilation and post-ventilation
- PED** PED version for continuous operation

SCOPE OF SUPPLY

The burner is delivered in its package complete with:

- 1 burner head with flange seal and securing screws
- 1 compact gas train with gas filter; the gas filter is built-in for threaded valves (up to 2") and separated for flanged ones (DN65/80/100)
- 1 bag containing installation fittings
- 1 bag containing technical documentation (instruction manual, technical data, electrical diagram, exploded view and spare parts list)



DIMENSIONS (mm)

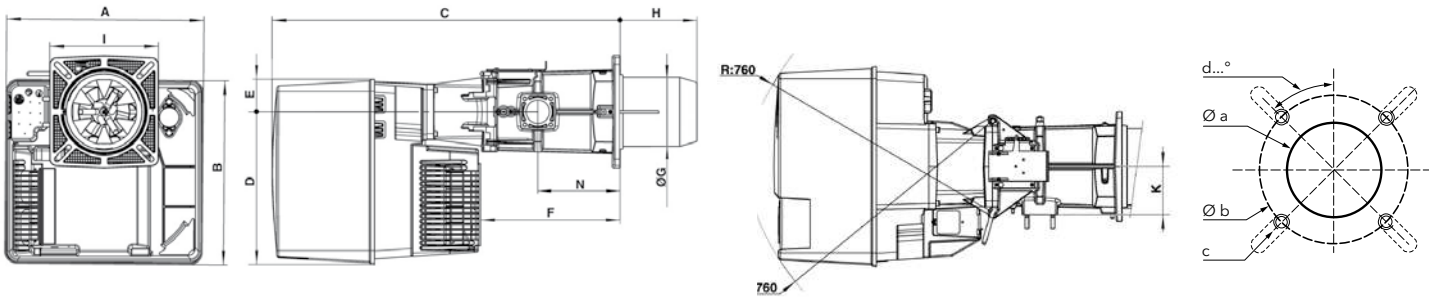

| A | B | C | D | E | F | ØG | H | | | I | K | N |
|-----|-----|------|-----|----|-----|-----|-----|-----|-----|---------|-----|-----|
| | | | | | | | KN | KM | KL | | | |
| 592 | 553 | 1050 | 456 | 97 | 421 | 227 | 270 | 370 | 470 | 326x335 | 144 | 247 |

| Øa (mm) | b (mm) | c | d |
|---------|---------|-----|-----|
| 250 | 300-400 | M12 | 45° |

Gas trains

Gas train "d":

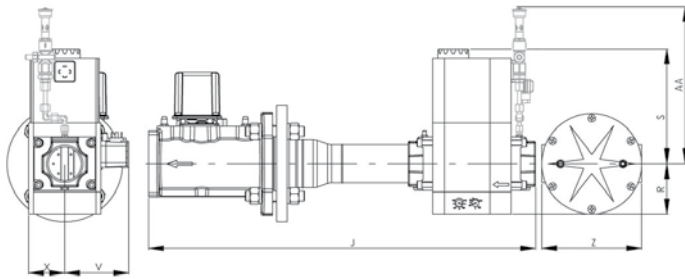

| Model | J | R | S | V | X | Z | AA* |
|-------------|-----|-----|-----|-----|----|-----|-----|
| d65-DN65 | 490 | 183 | 245 | 110 | 98 | 290 | 385 |
| d2"-Rp2" | 700 | 96 | 330 | 125 | 81 | - | 385 |
| d1"1/2-Rp2" | 622 | 80 | 185 | 102 | 57 | - | 320 |

Gas train "s":

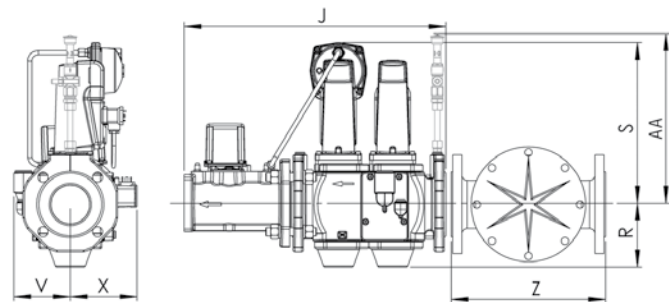

| Model | J | R | S | V | X | Z | AA* |
|----------|-----|-----|-----|-----|-----|-----|-----|
| s65-DN65 | 490 | 118 | 300 | 106 | 126 | 290 | 365 |

*: for PED configuration

PACKAGING

The burner is delivered on a pallet in three packages containing:

- burner housing
- combustion head
- gas train and filter

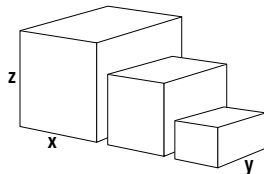

| Component | | Dimensions (mm) | | | Gross weight (kg) |
|-----------------|----------------|-----------------|-----|-----|-------------------|
| | | X | Y | Z | |
| Burner body | VG6.1600 M V R | 800 | 600 | 850 | 67,8 |
| | VG6.2100 M V R | 800 | 600 | 850 | 69,2 |
| Combustion head | KN | 1000 | 380 | 420 | 26,7 |
| | KL | 1100 | 380 | 430 | 29,4 |
| | KM | 1100 | 380 | 430 | 28 |
| Gas train | s65-DN65/TC | 670 | 550 | 380 | 29,4 |
| | d65-DN65/TC | 670 | 550 | 380 | 33 |
| | d2"-Rp2"/TC | 670 | 550 | 380 | 16,5 |
| | d1"1/2-Rp2"/TC | 670 | 550 | 380 | 14,3 |

VG6.1600 M V R / VG6.2100 M V R

200 ... 2300 kW

Two stage progressive/modulating electronic + fan speed control

PRESSURE LOSS [BURNER HEAD + GAS TRAIN] (mbar)

VG6.1600 M V R

| Burner output (kW) | Natural gas G20 Hi = 10,35 kWh/m ³ | | | | Natural gas G25 Hi = 8,83 kWh/m ³ | | | | LPG G31 |
|--------------------|---|----------|----------|----------|--|----------|----------|----------|-------------|
| | d1"1/2-Rp2" | d2"-Rp2" | d65-DN65 | s65-DN65 | d1"1/2-Rp2" | d2"-Rp2" | d65-DN65 | s65-DN65 | d1"1/2-Rp2" |
| 800 | 17 | 7 | 5 | 6 | 25 | 10 | 8 | 9 | 5 |
| 1000 | 25 | 11 | 8 | 9 | 37 | 16 | 11 | 13 | 7 |
| 1200 | 36 | 16 | 11 | 13 | 54 | 23 | 16 | 19 | 10 |
| 1400 | 49 | 21 | 15 | 17 | 73 | 32 | 22 | 25 | 13 |
| 1600 | 64 | 28 | 19 | 22 | 96 | 41 | 29 | 33 | 17 |

Natural gas G20

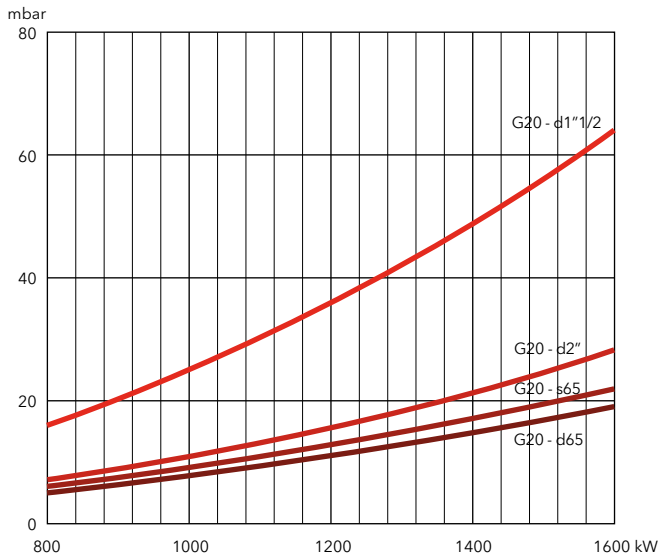

Natural gas G25

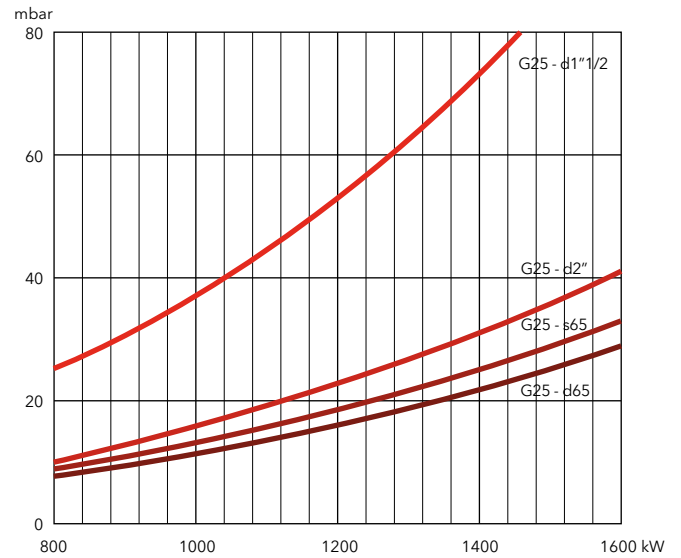

LPG

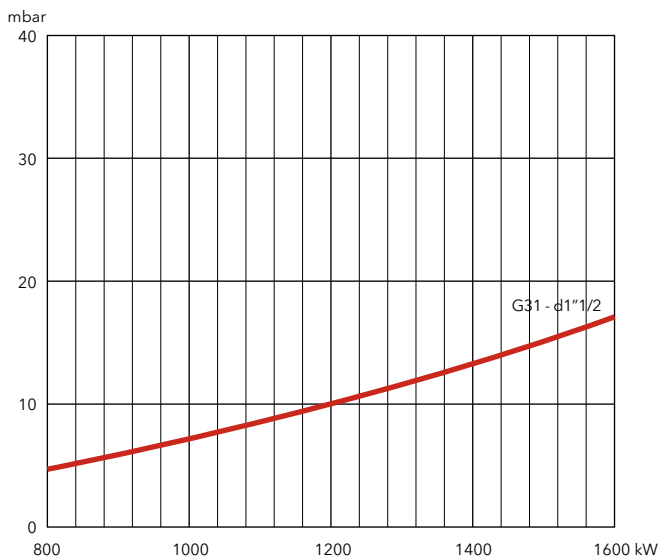



PRESSURE LOSS [BURNER HEAD + GAS TRAIN] (mbar)

VG6.2100 M V R

| Burner output (kW) | Natural gas G20 Hi = 10,35 kWh/m ³ | | | | Natural gas G25 Hi = 8,83 kWh/m ³ | | | | LPG G31 Hi = 25,89 kWh/m ³ | |
|--------------------|---|----------|----------|----------|--|----------|----------|----------|---------------------------------------|----------|
| | d1"1/2-Rp2" | d2"-Rp2" | d65-DN65 | s65-DN65 | d1"1/2-Rp2" | d2"-Rp2" | d65-DN65 | s65-DN65 | d1"1/2-Rp2" | d2"-Rp2" |
| 1300 | 40 | 16 | 10 | 12 | 60 | 24 | 15 | 18 | 19 | 9 |
| 1500 | 53 | 21 | 13 | 16 | 78 | 31 | 20 | 24 | 25 | 11 |
| 1700 | 68 | 27 | 17 | 20 | 102 | 40 | 26 | 30 | 32 | 14 |
| 1900 | 85 | 34 | 22 | 26 | 127 | 50 | 32 | 38 | 40 | 18 |
| 2100 | 104 | 41 | 27 | 31 | 156 | 61 | 40 | 46 | 48 | 22 |
| 2300 | 125 | 49 | 32 | 37 | 186 | 73 | 48 | 56 | 58 | 27 |

Natural gas G20

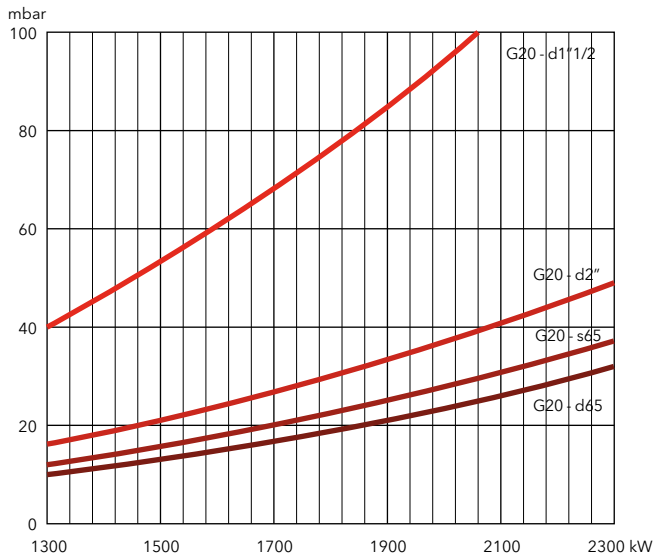

Natural gas G25

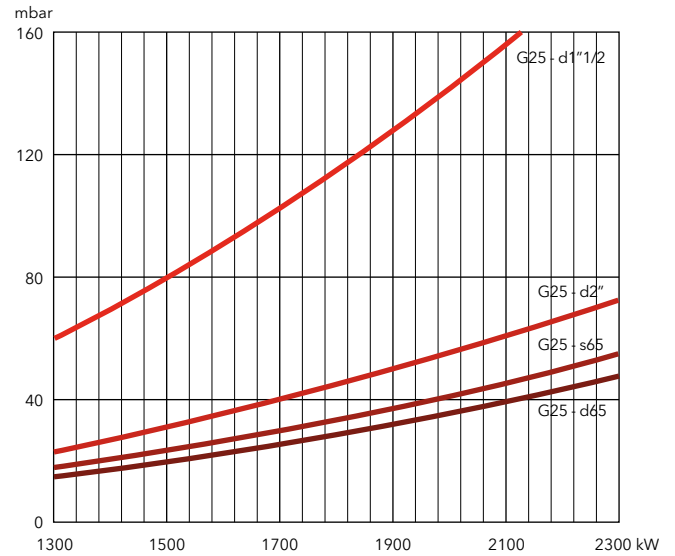

LPG

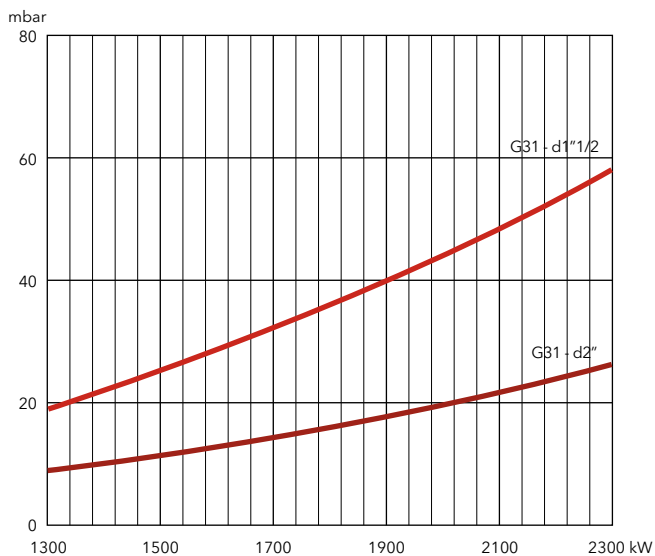

VGL2.120 / VGL2.210

35 ... 190 kW

One stage in gas / One stage in light oil



- **Fuels:** natural gas (G20/G25, $H_u = 8,83...10,35 \text{ kWh/m}^3$);
light oil (viscosity $6 \text{ mm}^2/\text{s}$ at 20°C , $H_u = 11,86 \text{ kWh/kg}$)
- **Emissions:** Low NOx class 2 in gas ($\leq 120 \text{ mg/kWh}$) according to EN676
Low NOx class 2 in light oil ($\leq 185 \text{ mg/kWh}$) according to EN267
- **Protection level:** IP 21

TECHNICAL DATA

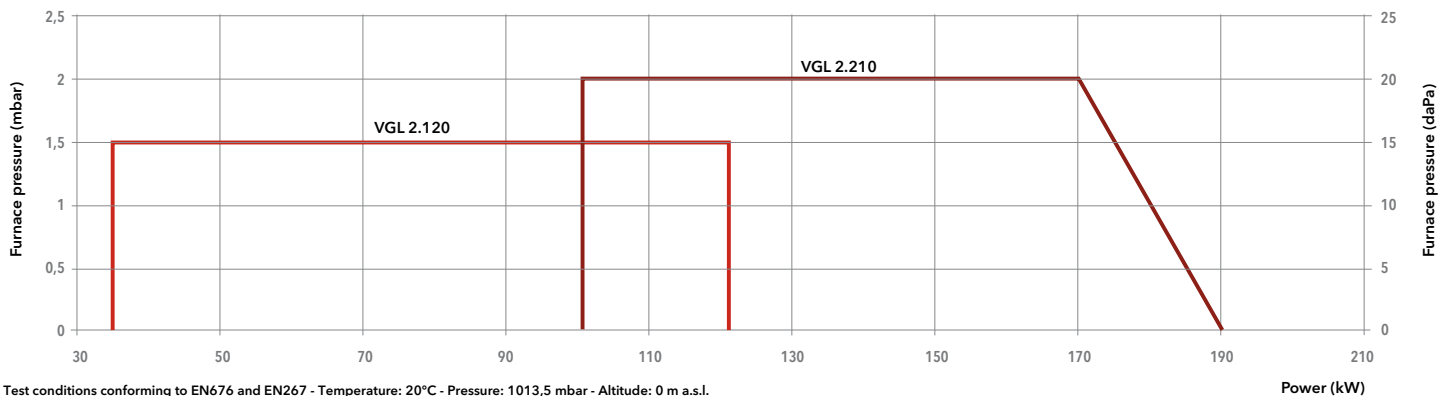

| Model | VGL2.120 | VGL2.210 |
|---|-----------------------|-----------------------|
| Operation range | 35 - 120 kW | 100 - 190 kW |
| Gas pressure | 20 - 300 mbar | 20 - 300 mbar |
| Control box / flame detection | TCG 1... / IRD 1020 | TCG 1... / IRD 1020 |
| Fan motor | 230 V - 50 Hz - 160 W | 230 V - 50 Hz - 130 W |
| Nozzle | 1,85 US gal/h 45°S | 2,75 US gal/h 45°B |
| Electrical consumption | 186 W | 246 W |
| Acoustic level (LpA) | 62 dB(A) | 65,2 dB(A) |
| CE certificate | 1312 BU 5219 | 1312 BU 5219 |
| Head length | KL | KL |
| Complete burner MB-DLE 407 d3/4"-Rp3/4" | 3833494 | 3833495 |

OTHER AVAILABLE VERSIONS

 Versions for continuous ventilation and post-ventilation

SCOPE OF SUPPLY

The burner is delivered in its package complete with:

- 1 gas connection flange
- 1 compact gas train with gas filter; the gas filter is built-in for threaded valves (up to 2") and separated for flanged ones (DN65/80/100)
- 1 burner flange with insulation
- 1 bag containing installation fittings
- 1 bag containing technical documentation (instruction manual, technical data, electrical diagram, exploded view and spare parts list)

DIMENSIONS (mm)

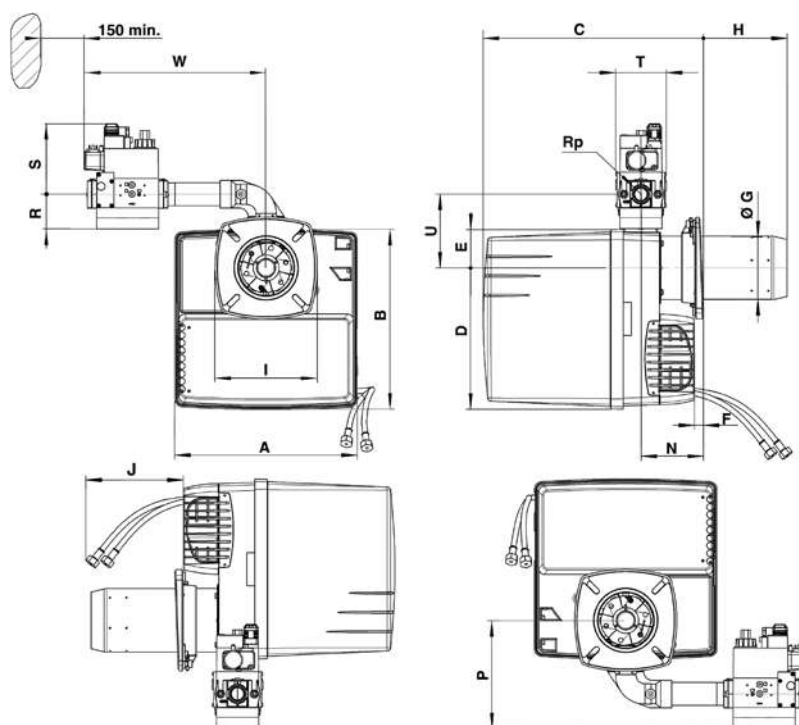

| A | B | C | D | E | F min | ØG | H | I | J | N min | P | Rp | R | S | T | U | W |
|-----|-----|-----------|-----|----|-------|-----|----------|-----|-----|-------|-----|------|----|-----|-----|-----|-----|
| | | KL | | | | | KL | | | | | | | | | | |
| 331 | 325 | 398...638 | 256 | 69 | 15 | 115 | 30...270 | 185 | 700 | 113 | 115 | 3/4" | 46 | 140 | 120 | 133 | 330 |

Connecting flange

| Øa (mm) | b (mm) | c | d |
|---------|---------|----|-----|
| 130-140 | 172-184 | M8 | 45° |

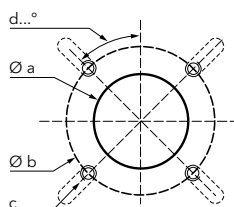

PACKAGING

The burner is delivered in a single package containing all the components

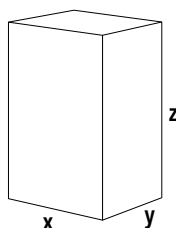

| Burner | Dimensions (mm) | | | Gross weight (kg) |
|----------|-----------------|-----|-----|-------------------|
| | X | Y | Z | |
| VGL2.120 | 400 | 400 | 770 | 23 |
| VGL2.210 | 400 | 400 | 770 | 24 |

VGL3.290 D / VGL3.360 D

95 ... 360 kW

Two stages in gas / Two stages in light oil

- **Fuels:** natural gas (G20/G25, $H_u = 8,83...10,35 \text{ kWh/m}^3$);
light oil (viscosity $6 \text{ mm}^2/\text{s}$ at 20°C , $H_u = 11,86 \text{ kWh/kg}$)
- **Emissions:** Low NOx class 3 in gas ($\leq 80 \text{ mg/kWh}$) according to EN676
Low NOx class 2 in light oil ($\leq 185 \text{ mg/kWh}$) according to EN267
- **Protection level:** IP 41



TECHNICAL DATA

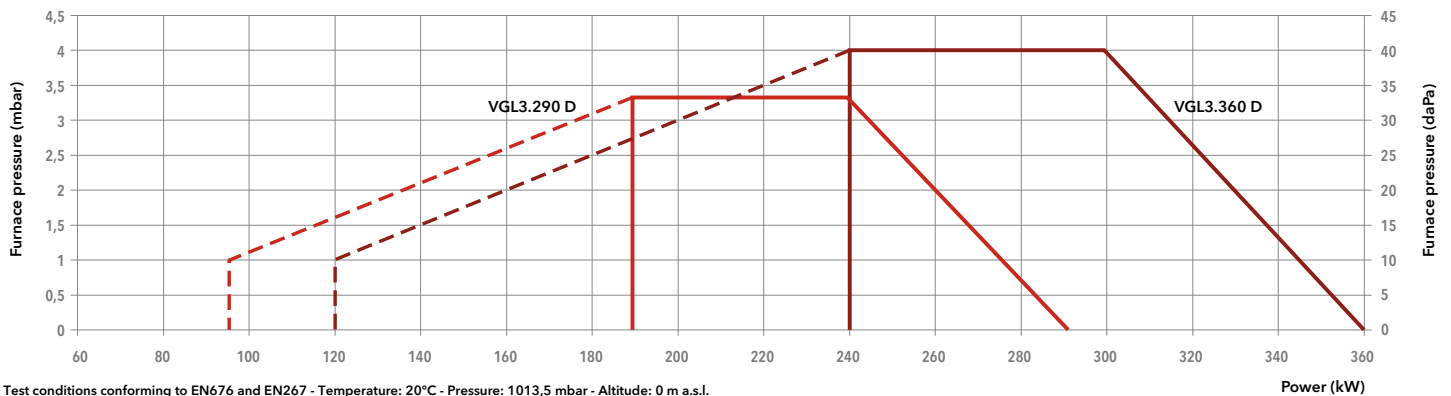

| Model | VGL3.290 D | | VGL3.360 D | |
|-------------------------------|------------------------------|---------|-----------------------|---------|
| Operation range | (95) 190 - 290 kW | | (120) 240 - 360 kW | |
| Gas pressure | 20 - 300 mbar | | 20 - 300 mbar | |
| Control box / flame detection | TCG2... / ionization | | TCG2... / ionization | |
| Fan motor | 230 V - 50 Hz - 300 W | | 230 V - 50 Hz - 300 W | |
| Electrical consumption | 512 W | | 512 W | |
| Acoustic level (LpA) | 67 dB(A) | | 69 dB(A) | |
| CE certificate | 0085 CP 0304 | | 0085 CP 0304 | |
| Head length | KN | KL | KN | KL |
| Complete burner code | MB-ZRDLE 420 d1"1/2-Rp2" | - | 3834467 | 3834468 |
| | MB-ZRDLE 412 d1"1/4-Rp1"1/4" | 3834461 | 3834465 | 3834466 |
| | MB-ZRDLE 407 d3/4"-Rp3/4" | 3834459 | 3834460 | 3834463 |

OTHER AVAILABLE VERSIONS

Versions for continuous ventilation and post-ventilation

SCOPE OF SUPPLY

The burner is delivered in its package complete with:

- 1 burner head with flange seal and securing screws
- 1 compact gas train with gas filter; the gas filter is built-in for threaded valves (up to 2") and separated for flanged ones (DN65/80/100)
- 1 bag containing installation fittings
- 1 bag containing technical documentation (instruction manual, technical data, electrical diagram, exploded view and spare parts list)



DIMENSIONS (mm)

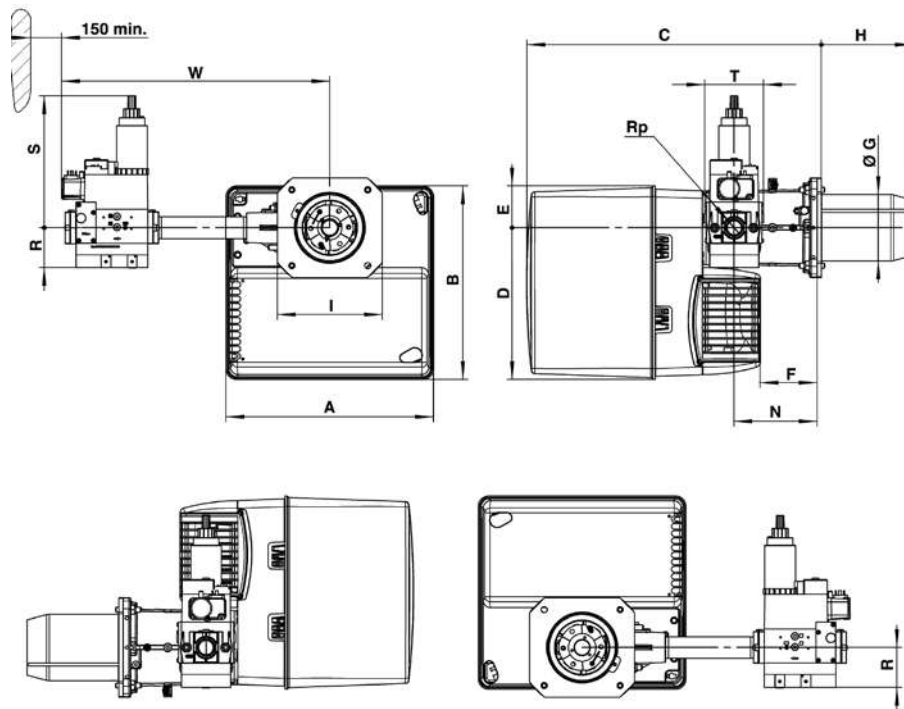

| Gas train model | A | B | C | D | E | F | ØG | H | | I | N | Rp | R | S | T | W |
|-----------------|-----|-----|-----|-----|----|-----|-----|-----|-----|---------|-----|-------|----|-----|-----|-----|
| | | | | | | | | KN | KL | | | | | | | |
| d1"1/2-Rp2" | 406 | 379 | 576 | 297 | 82 | 120 | 130 | 180 | 320 | 195x205 | 170 | 2" | 80 | 330 | 100 | 603 |
| d1"1/4-Rp1"1/4 | 406 | 379 | 576 | 297 | 82 | 120 | 130 | 180 | 320 | 195x205 | 170 | 1"1/4 | 55 | 260 | 145 | 526 |
| d3/4"-Rp3/4" | 406 | 379 | 576 | 297 | 82 | 120 | 130 | 180 | 320 | 195x205 | 170 | 3/4" | 46 | 210 | 120 | 479 |

Connecting flange

| Øa (mm) | b (mm) | c | d |
|---------|---------|-----|-----|
| 155-190 | 175-220 | M10 | 45° |

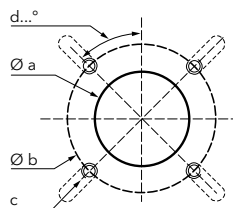

PACKAGING

The burner is delivered on a pallet in three packages containing:

- burner housing
- combustion head
- gas train and filter

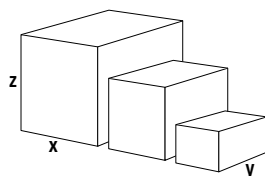

| Component | | Dimensions (mm) | | | Gross weight (kg) |
|-----------------|----------------|-----------------|-----|-----|-------------------|
| | | X | Y | Z | |
| Burner body | VGL3.290 D | 440 | 400 | 520 | 21 |
| | VGL3.360 D | 440 | 400 | 520 | 22 |
| Combustion head | KN | 650 | 210 | 260 | 6 |
| | KL | 780 | 210 | 260 | 7 |
| Gas train | d1"1/2-Rp2" | 600 | 400 | 240 | 14 |
| | d1"1/4-Rp1"1/4 | 440 | 320 | 240 | 10 |
| | d3/4"-Rp3/4" | 440 | 320 | 240 | 7 |

VGL3.290 D / VGL3.360 D

95 ... 360 kW

Two stages in gas / Two stages in light oil

PRESSURE LOSS [BURNER HEAD + GAS TRAIN] (mbar)

VGL3.290 D

| Burner output (kW) | Natural gas G20 Hi = 10,35 kWh/m ³ | | Natural gas G25 Hi = 8,83 kWh/m ³ | |
|--------------------|---|----------------|--|----------------|
| | d3/4"-Rp3/4" | d1"1/4-Rp1"1/4 | d3/4"-Rp3/4" | d1"1/4-Rp1"1/4 |
| 190 | 14 | 6 | 18 | 6 |
| 210 | 17 | 8 | 22 | 8 |
| 230 | 20 | 10 | 26 | 10 |
| 250 | 23 | 11 | 31 | 11 |
| 270 | 27 | 13 | 37 | 13 |
| 290 | 32 | 16 | 43 | 16 |

Natural gas G20

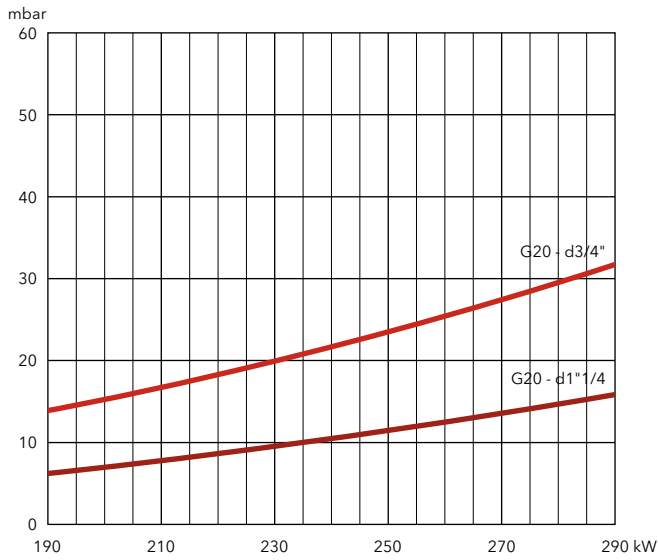

Natural gas G25

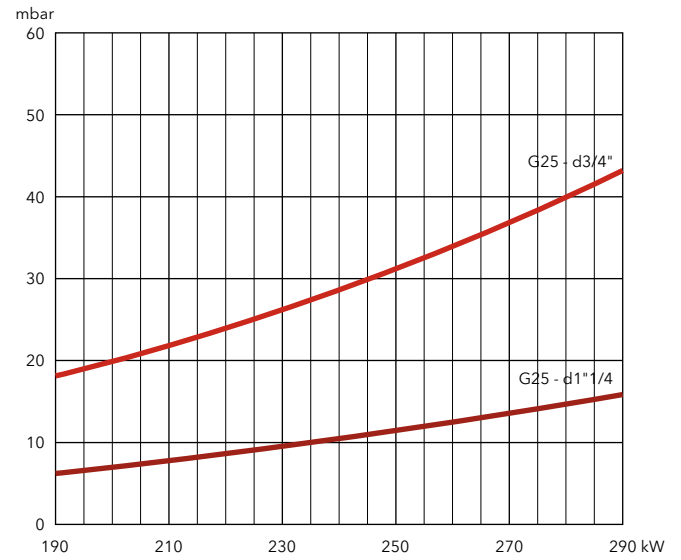



PRESSURE LOSS [BURNER HEAD + GAS TRAIN] (mbar)

VGL3.360 D

| Burner output (kW) | Natural gas G20 Hi = 10,35 kWh/m ³ | | Natural gas G25 Hi = 8,83 kWh/m ³ | | |
|--------------------|---|----------------|--|----------------|-------------|
| | d3/4"-Rp3/4" | d1"1/4-Rp1"1/4 | d3/4"-Rp3/4" | d1"1/4-Rp1"1/4 | d1"1/2-Rp2" |
| 240 | 22 | 9 | 25 | 9 | 8 |
| 280 | 29 | 12 | 35 | 12 | 11 |
| 320 | 38 | 16 | 46 | 16 | 14 |
| 360 | 49 | 21 | 59 | 21 | 18 |

Natural gas G20

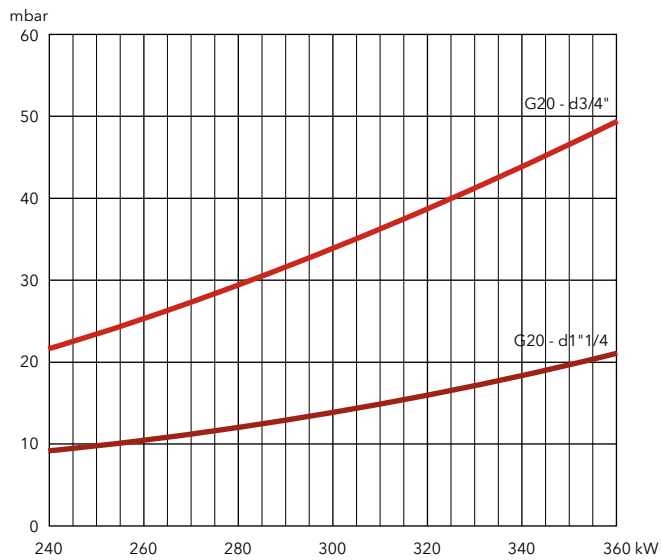

Natural gas G25

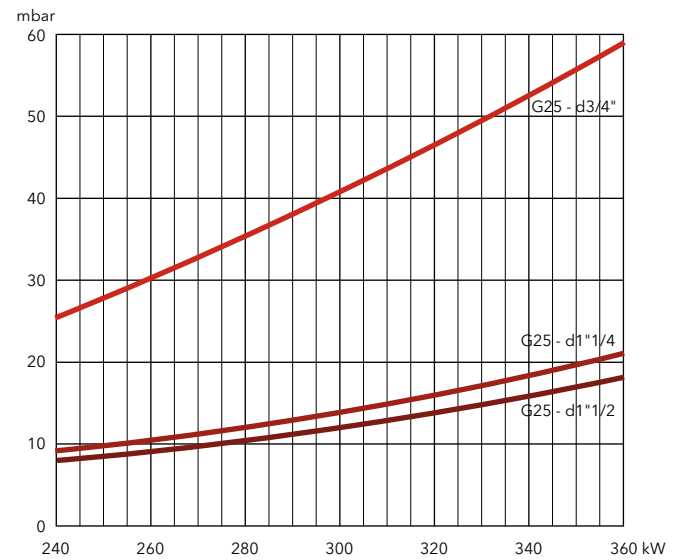

VGL4.460 DP / VGL4.610 DP

168 ... 610 kW

Two stage progressive/modulating pneumatic in gas / Two stages in oil

- **Fuels:** natural gas (G20/G25, $H_u = 8,83...10,35 \text{ kWh/m}^3$);
light oil (viscosity $6 \text{ mm}^2/\text{s}$ at 20°C , $H_u = 11,86 \text{ kWh/kg}$)
- **Emissions:** Low NOx class 3 in gas ($\leq 80 \text{ mg/kWh}$) according to EN676
Low NOx class 2 in light oil ($\leq 185 \text{ mg/kWh}$) according to EN267
- **Operation:** two stage progressive or modulating with the installation
of a power regulator and dedicated probes (see page 198) in gas
and two stages in light oil
- **Protection level:** IP 41



TECHNICAL DATA

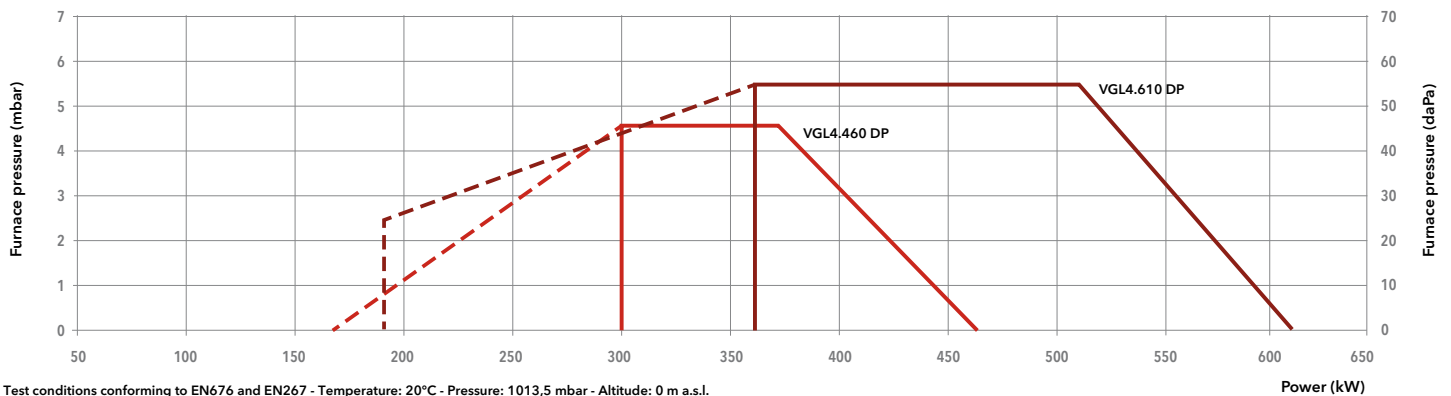

| Model | VGL4.460 DP | | VGL4.610 DP | |
|-------------------------------|---------------------------|---------|-----------------------|---------|
| Operation range | (168) 300 - 460 kW | | (190) 360 - 610 kW | |
| Gas pressure | 20 - 300 mbar | | 20 - 300 mbar | |
| Control box / flame detection | TCG5... / ionization | | TCG5... / ionization | |
| Fan motor | 230 V - 50 Hz - 420 W | | 230 V - 50 Hz - 750 W | |
| Electrical consumption | 68 + 522 W | | 68 + 720 W | |
| Acoustic level (LpA) | 70 dB(A) | | 71 dB(A) | |
| CE certificate | 0085 CP 0304 | | 0085 CP 0304 | |
| Head length | KN | KL | KN | KL |
| Complete burner code | MB-VEF 420 d1"1/2-Rp2" | 3834576 | 3834582 | 3834583 |
| | MB-VEF 412 d1"1/4-Rp1"1/4 | 3834574 | 3834580 | 3834581 |
| | MB-VEF 407 d3/4"-Rp1" | 3834572 | 3834578 | 3834579 |

OTHER AVAILABLE VERSIONS

 Versions for continuous ventilation and post-ventilation

SCOPE OF SUPPLY

The burner is delivered in its package complete with:

- 1 burner head with flange seal and securing screws
- 1 compact gas train with gas filter; the gas filter is built-in for threaded valves (up to 2") and separated for flanged ones (DN65/80/100)
- 1 bag containing installation fittings
- 1 bag containing technical documentation (instruction manual, technical data, electrical diagram, exploded view and spare parts list)



DIMENSIONS (mm)

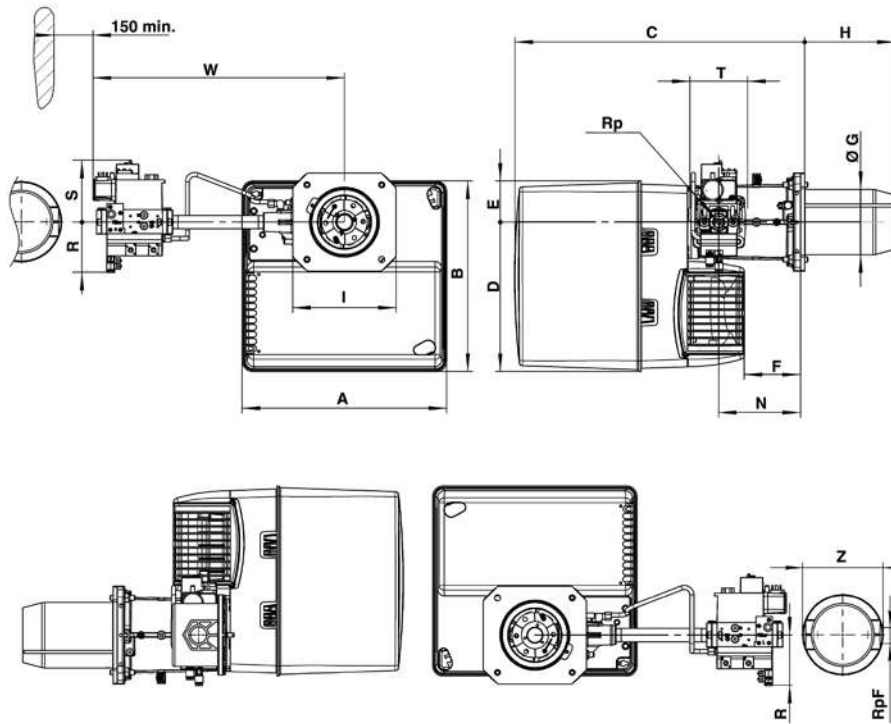

| Gas train model | A | B | C | D | E | F | Ø G | H | | I | N | Rp | R | S | T | W | RpF | Z |
|-----------------|-----|-----|-----|-----|----|-----|-----|-----|-----|-----|-----|-------|-----|-----|-----|-----|-----|-----|
| | | | | | | | | KN | KL | | | | | | | | | |
| d1"1/2-Rp2" | 465 | 475 | 640 | 377 | 97 | 149 | 150 | 220 | 360 | 245 | 195 | 2" | 100 | 185 | 100 | 613 | - | - |
| d1"1/4-Rp1"1/4 | 465 | 475 | 640 | 377 | 97 | 149 | 150 | 220 | 360 | 245 | 195 | 1"1/4 | 80 | 175 | 145 | 536 | - | - |
| d3/4"-Rp1" | 465 | 475 | 640 | 377 | 97 | 149 | 150 | 220 | 360 | 245 | 195 | 1" | 70 | 160 | 120 | 489 | 1" | 160 |

Connecting flange

| Øa (mm) | b (mm) | c | d |
|---------|---------|-----|-----|
| 190-240 | 200-270 | M10 | 45° |

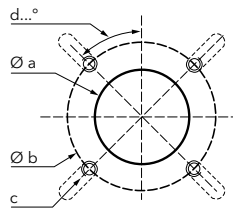

PACKAGING

The burner is delivered on a pallet in three packages containing:

- burner housing
- combustion head
- gas train and filter

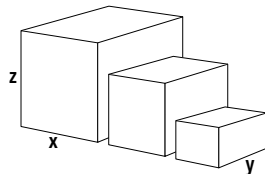

| Component | | Dimensions (mm) | | | Gross weight (kg) |
|-----------------|----------------|-----------------|-----|-----|-------------------|
| | | X | Y | Z | |
| Burner body | VGL4.460 DP | 490 | 490 | 590 | 28,6 |
| | VGL4.610 DP | 490 | 490 | 590 | 32,7 |
| Combustion head | KN | 750 | 260 | 295 | 8,9 |
| | KL | 895 | 260 | 295 | 10,1 |
| Gas train | d1"1/2-Rp2" | 670 | 550 | 380 | 12 |
| | d1"1/4-Rp1"1/4 | 600 | 400 | 240 | 11 |
| | d3/4"-Rp1" | 600 | 400 | 240 | 7 |

VGL4.460 DP / VGL4.610 DP

168 ... 610 kW

Two stage progressive/modulating pneumatic in gas / Two stages in oil

PRESSURE LOSS [BURNER HEAD + GAS TRAIN] (mbar)

VGL4.460 DP

| Burner output (kW) | Natural gas G20 Hi = 10,35 kWh/m ³ | | Natural gas G25 Hi = 8,83 kWh/m ³ | | |
|--------------------|---|----------------|--|----------------|-------------|
| | d3/4"-Rp3/4" | d1"1/4-Rp1"1/4 | d3/4"-Rp3/4" | d1"1/4-Rp1"1/4 | d1"1/2-Rp2" |
| 300 | 37 | 7 | 50 | 13 | 8 |
| 340 | 47 | 10 | 65 | 17 | 10 |
| 380 | 59 | 12 | 81 | 21 | 13 |
| 420 | 72 | 15 | 99 | 26 | 15 |
| 460 | 86 | 18 | 118 | 31 | 19 |

Natural gas G20

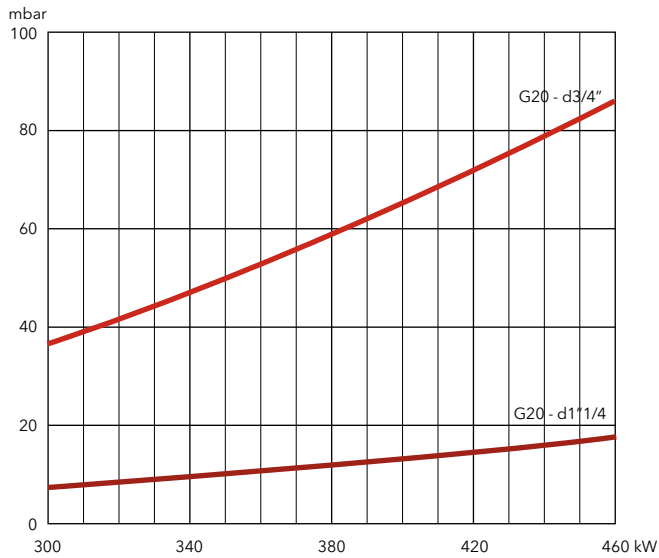

Natural gas G25

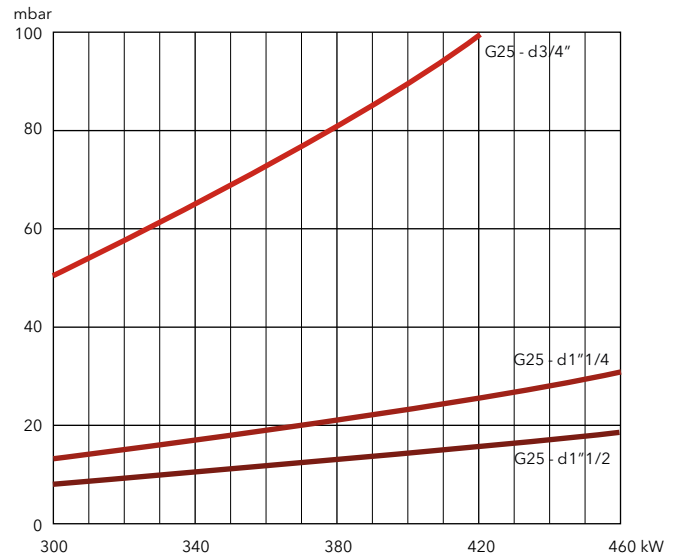



PRESSURE LOSS [BURNER HEAD + GAS TRAIN] (mbar)

VGL4.610 DP

| Burner output (kW) | Natural gas G20 Hi = 10,35 kWh/m ³ | | | Natural gas G25 Hi = 8,83 kWh/m ³ | |
|--------------------|---|----------------|-------------|--|-------------|
| | d3/4"-Rp3/4" | d1"1/4-Rp1"1/4 | d1"1/2-Rp2" | d1"1/4-Rp1"1/4 | d1"1/2-Rp2" |
| 300 | 51 | 9 | 5 | 12 | 8 |
| 400 | 91 | 16 | 9 | 21 | 14 |
| 500 | 142 | 24 | 15 | 33 | 22 |
| 600 | 204 | 35 | 21 | 48 | 32 |

Natural gas G20

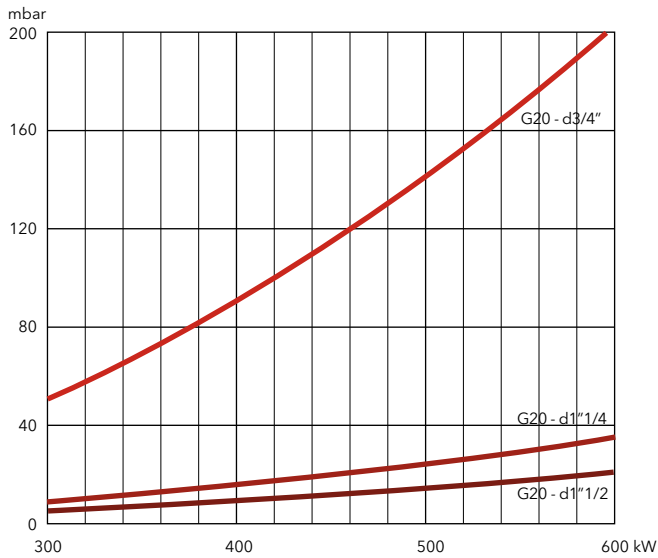

Natural gas G25

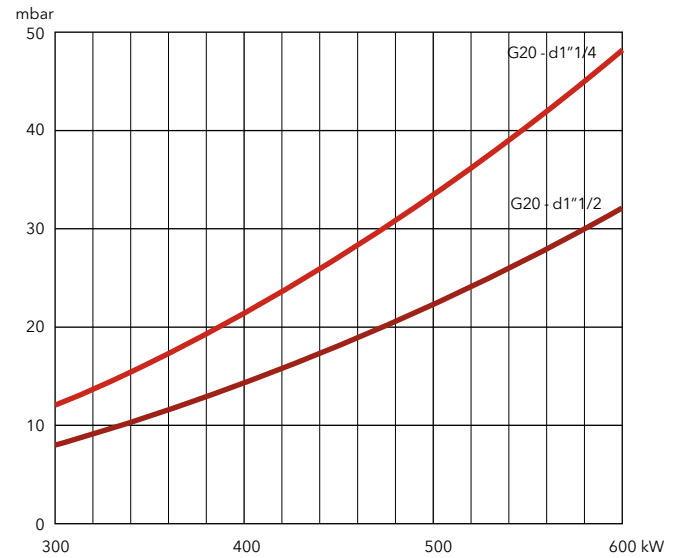

VGL5.700 M / VGL5.1000 M

200 ... 1000 kW

Two stage progressive/modulating electronic in gas / Three stages in oil



- **Fuels:** natural gas (G20/G25, $H_u = 8,83...10,35 \text{ kWh/m}^3$);
light oil (viscosity $6 \text{ mm}^2/\text{s}$ at 20°C , $H_u = 11,86 \text{ kWh/kg}$)
- **Emissions:** Low NOx class 3 in gas ($\leq 80 \text{ mg/kWh}$) according to EN676
Low NOx class 2 in light oil ($\leq 185 \text{ mg/kWh}$) according to EN267
- **Operation:** two stage progressive or modulating with the installation of a power regulator and dedicated probes (see page 198) in gas and three stages in light oil
- **Protection level:** IP 41

TECHNICAL DATA

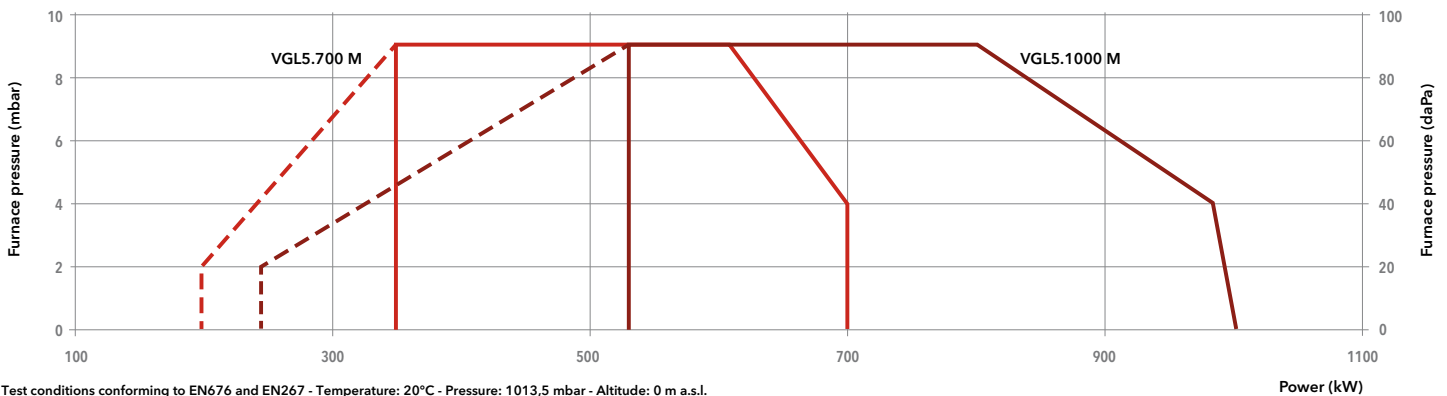

Test conditions conforming to EN676 and EN267 - Temperature: 20°C - Pressure: 1013,5 mbar - Altitude: 0 m a.s.l.

| Model | VGL5.700 M /TC | | | VGL5.1000 M /TC | | | | |
|-------------------------------|---|----------------|---------|---|---------|---------|---------|---------|
| Operation range | (200) 350 – 700 kW | | | (240) 530 – 1000 kW | | | | |
| Gas pressure | 20 – 300 mbar | | | 20 – 300 mbar | | | | |
| Control box / flame detection | BT3... / QRA 2 | | | BT3... / QRA 2 | | | | |
| Fan motor | 230/400 V – 50 Hz – 1,1 kW | | | 230/400 V – 50 Hz – 1,5 kW | | | | |
| Nozzle | 4,5 US gal/h 45°B / 5 US gal/h 45°B | | | 5 US gal/h 45°B / 8,5 US gal/h 45°B | | | | |
| Electrical consumption | 2000 W | | | 2200 W | | | | |
| Acoustic level (LpA) | 78 dB(A) | | | 81 dB(A) | | | | |
| CE certificate | 1312 AQ 924 | | | 1312 AQ 925 | | | | |
| Head length | | KN | KL | KM | KN | KL | KM | |
| Complete burner code | VDG 40-065 | s65-DN65 | - | - | - | 3836654 | 3836656 | 3836655 |
| | MBC1900 | d65-DN65 | - | - | - | 3836657 | 3836659 | 3836658 |
| | MBC1200 | d2"-Rp2" | 3836645 | 3836647 | 3836646 | 3836660 | 3836662 | 3836661 |
| | MBC700 | d1 1/2"-Rp2" | 3836648 | 3836650 | 3836649 | 3836663 | 3836665 | 3836664 |
| | MBC300 | d3/4"-Rp1 1/4" | 3836651 | 3836653 | 3836652 | 3836666 | 3836668 | 3836667 |

OTHER AVAILABLE VERSIONS

 Versions for continuous ventilation and post-ventilation

SCOPE OF SUPPLY

The burner is delivered in its package complete with:

- 1 burner head with flange seal and securing screws
- 1 compact gas train with gas filter; the gas filter is built-in for threaded valves (up to 2") and separated for flanged ones (DN65/80/100)
- 1 bag containing installation fittings
- 1 bag containing technical documentation (instruction manual, technical data, electrical diagram, exploded view and spare parts list)



DIMENSIONS (mm)

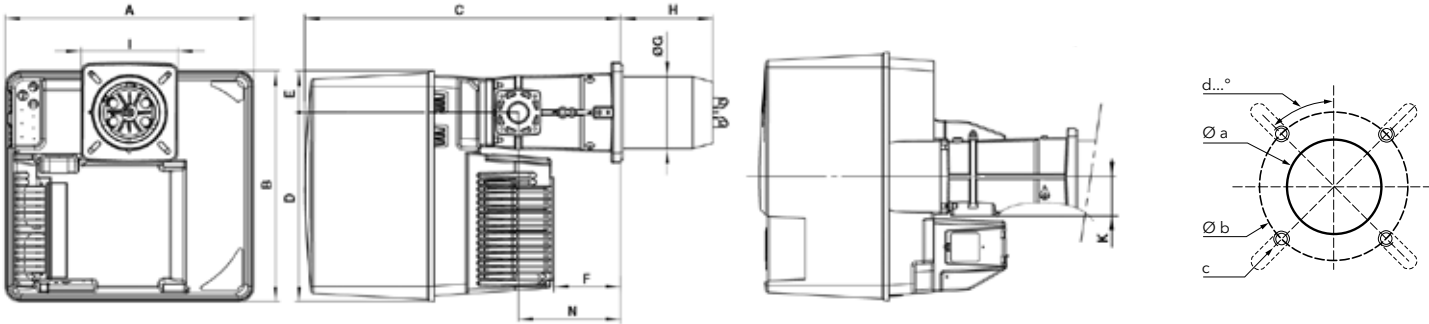

| A | B | C | D | E | F | ØG | H | | | I | K | N |
|-----|-----|-----|-----|----|-----|-----|-----|-----|-----|---------|----|-----|
| | | | | | | | KN | KM | KL | | | |
| 581 | 549 | 752 | 450 | 99 | 164 | 170 | 215 | 325 | 435 | 230x238 | 89 | 244 |

| Øa (mm) | b (mm) | c | d |
|---------|---------|-----|-----|
| 195 | 220-260 | M10 | 45° |

Gas trains

Gas train "d":

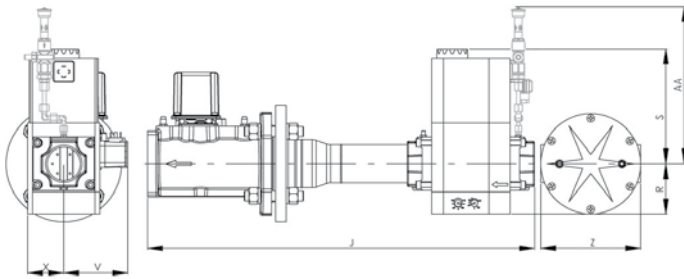

| Model | J | R | S | V | X | Z | AA* |
|---------------|-----|-----|-----|-----|----|-----|-----|
| d65-DN65 | 490 | 183 | 245 | 110 | 98 | 290 | 385 |
| d2"-Rp2" | 700 | 96 | 330 | 125 | 81 | - | 385 |
| d1"1/2-Rp2" | 622 | 80 | 185 | 102 | 57 | - | 320 |
| d3/4"-Rp1"1/4 | 460 | 60 | 173 | 88 | 58 | - | 320 |

Gas train "s":

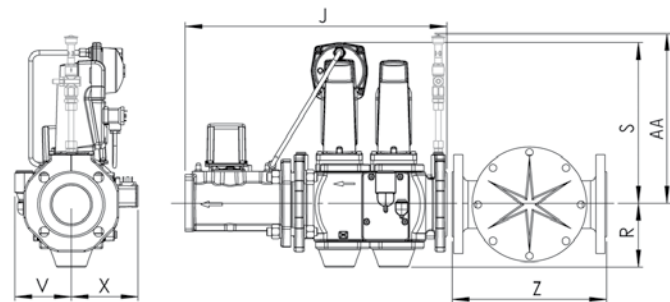

| Model | J | R | S | V | X | Z | AA* |
|----------|-----|-----|-----|-----|-----|-----|-----|
| s65-DN65 | 490 | 118 | 300 | 106 | 126 | 290 | 365 |

*: for PED configuration

PACKAGING

The burner is delivered on a pallet in three packages containing:

- burner housing
- combustion head
- gas train and filter

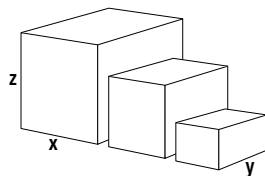

| Component | | Dimensions (mm) | | | Gross weight (kg) |
|-----------------|------------------|-----------------|-----|-----|-------------------|
| | | X | Y | Z | |
| Burner body | VG5.700 M | 800 | 600 | 850 | 70 |
| | VG5.1000 M | 800 | 600 | 850 | 70 |
| Combustion head | KN | 780 | 265 | 280 | 13 |
| | KL | 1010 | 265 | 280 | 16 |
| | KM | 1010 | 265 | 280 | 15 |
| Gas train | s65-DN65/TC | 670 | 530 | 380 | 26 |
| | d65-DN65/TC | 670 | 530 | 380 | 17 |
| | d2"-Rp2"/TC | 670 | 530 | 380 | 12 |
| | d1"1/2-Rp2"/TC | 670 | 530 | 380 | 12 |
| | d3/4"-Rp1"1/4/TC | 600 | 400 | 240 | 7 |

VGL5.700 M / VGL5.1000 M

200 ... 1000 kW

Two stage progressive/modulating electronic in gas / Three stages in oil

PRESSURE LOSS [BURNER HEAD + GAS TRAIN] (mbar)

VGL5.700 M

| Burner output (kW) | Natural gas G20 Hi = 10,35 kWh/m ³ | | | Natural gas G25 Hi = 8,83 kWh/m ³ | | | LPG G31 |
|--------------------|---|-------------|----------|--|-------------|----------|-------------|
| | d3/4-Rp1"1/4 | d1"1/2-Rp2" | d2"-Rp2" | d3/4-Rp1"1/4 | d1"1/2-Rp2" | d2"-Rp2" | d1"1/2-Rp2" |
| 500 | 31 | 9 | 8 | 37 | 11 | 9 | 6 |
| 550 | 35 | 11 | 9 | 45 | 13 | 10 | 7 |
| 600 | 43 | 13 | 10 | 53 | 16 | 12 | 8 |
| 650 | 49 | 15 | 11 | 62 | 18 | 13 | 9 |
| 700 | 58 | 17 | 13 | 73 | 21 | 15 | 10 |

Natural gas G20

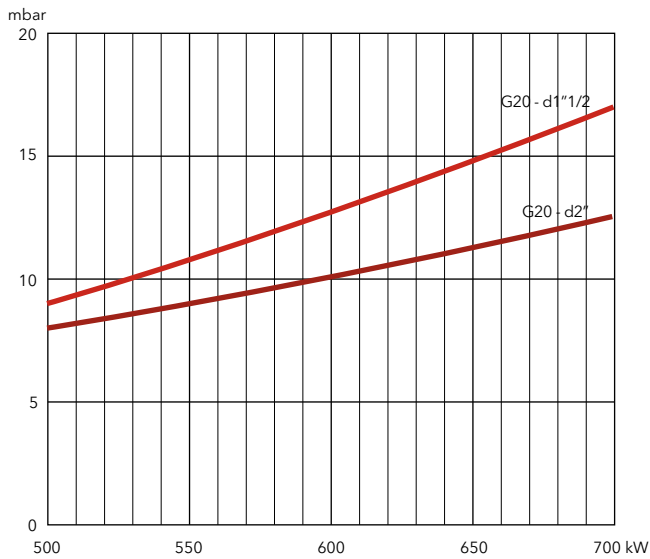

Natural gas G25

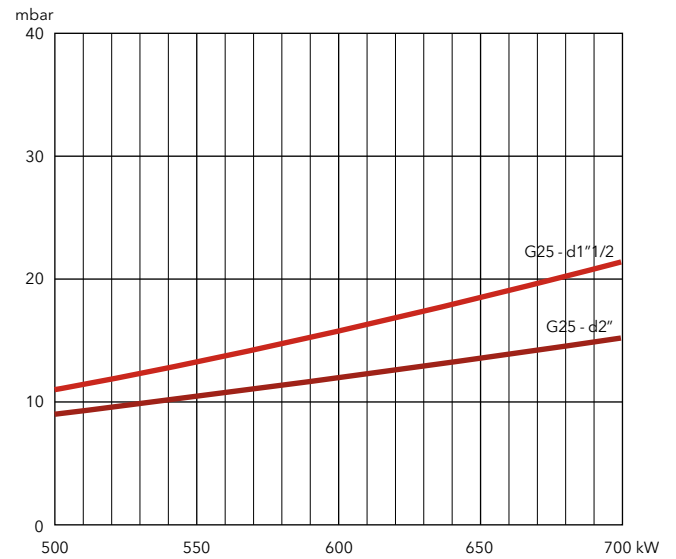

Natural gas G20, G25

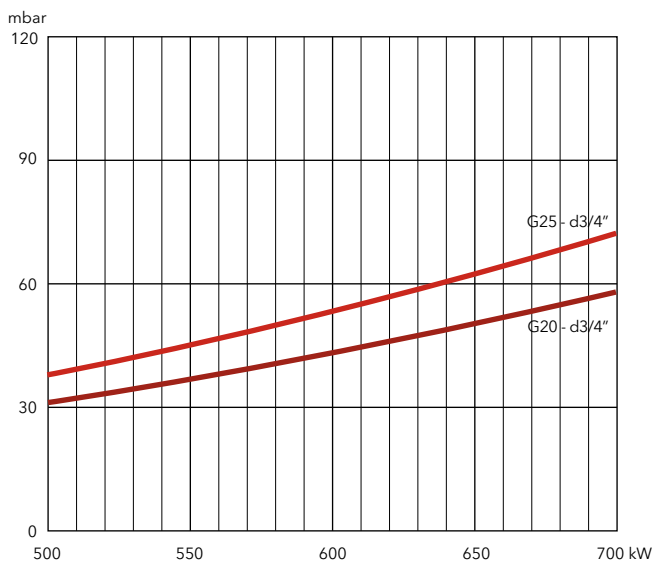

LPG

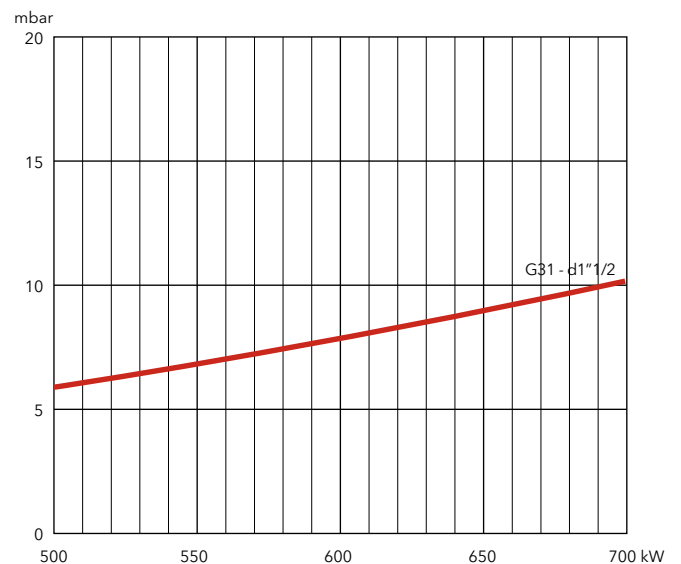



PRESSURE LOSS [BURNER HEAD + GAS TRAIN] (mbar)

VGL5.1000 M

| Burner output (kW) | Natural gas G20 Hi = 10,35 kWh/m ³ | | | | | Natural gas G25 Hi = 8,83 kWh/m ³ | | | | | LPG G31 |
|--------------------|---|-------------|----------|----------|----------|--|-------------|----------|----------|----------|-------------|
| | d3/4-Rp1"1/4 | d1"1/2-Rp2" | d2"-Rp2" | d65-DN65 | s65-DN65 | d3/4-Rp1"1/4 | d1"1/2-Rp2" | d2"-Rp2" | d65-DN65 | s65-DN65 | d1"1/2-Rp2" |
| 700 | 40 | 16 | 12 | 10 | 10 | 60 | 21 | 14 | 10 | 12 | 10 |
| 800 | 53 | 20 | 14 | 13 | 13 | 79 | 27 | 17 | 13 | 15 | 12 |
| 900 | 68 | 25 | 17 | 16 | 16 | 100 | 34 | 21 | 16 | 19 | 15 |
| 1000 | 84 | 31 | 21 | 20 | 20 | 126 | 42 | 26 | 20 | 24 | 18 |

Natural gas G20

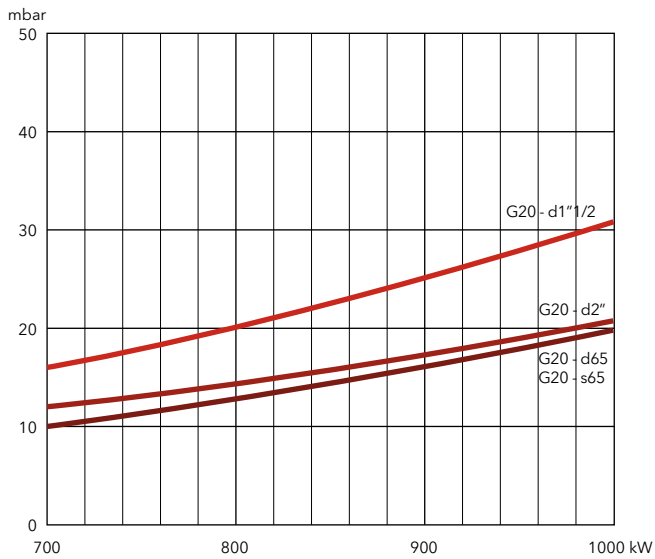

Natural gas G25

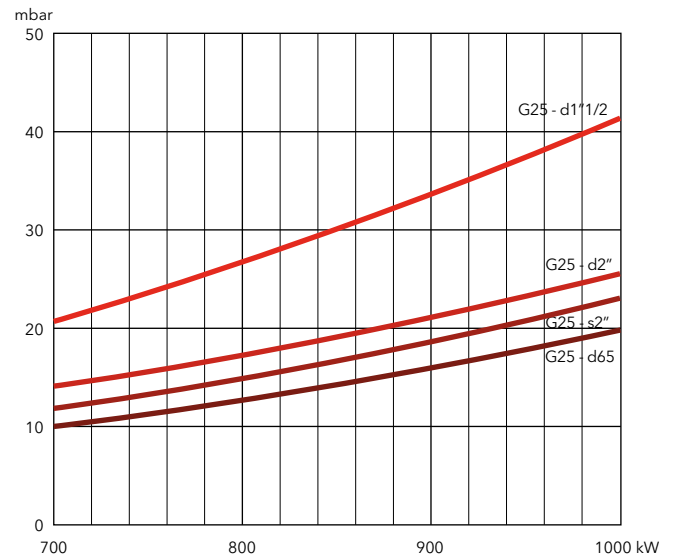

Natural gas G20, G25

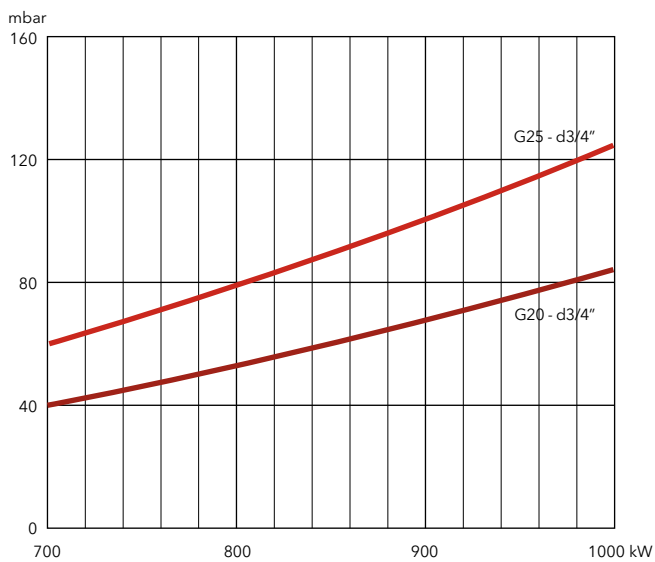

LPG

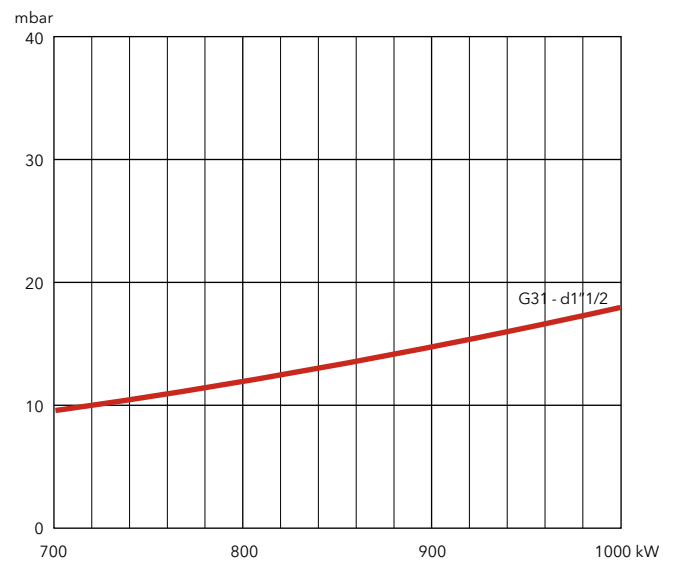

VGL6.1600 M / VGL6.2100 M

300 ... 2050 kW

Two stage progressive/modulating electronic in gas / Three stages in oil



- **Fuels:** natural gas (G20/G25, $H_u = 8,83 \dots 10,35 \text{ kWh/m}^3$);
light oil (viscosity $6 \text{ mm}^2/\text{s}$ at 20°C , $H_u = 11,86 \text{ kWh/kg}$)
- **Emissions:** Low NOx class 3 in gas ($\leq 80 \text{ mg/kWh}$) according to EN676
Low NOx class 2 in light oil ($\leq 185 \text{ mg/kWh}$) according to EN267
- **Operation:** two stage progressive or modulating with the installation of a power regulator and dedicated probes (see page 198) in gas and three stages in light oil
- **Protection level:** IP 41

TECHNICAL DATA

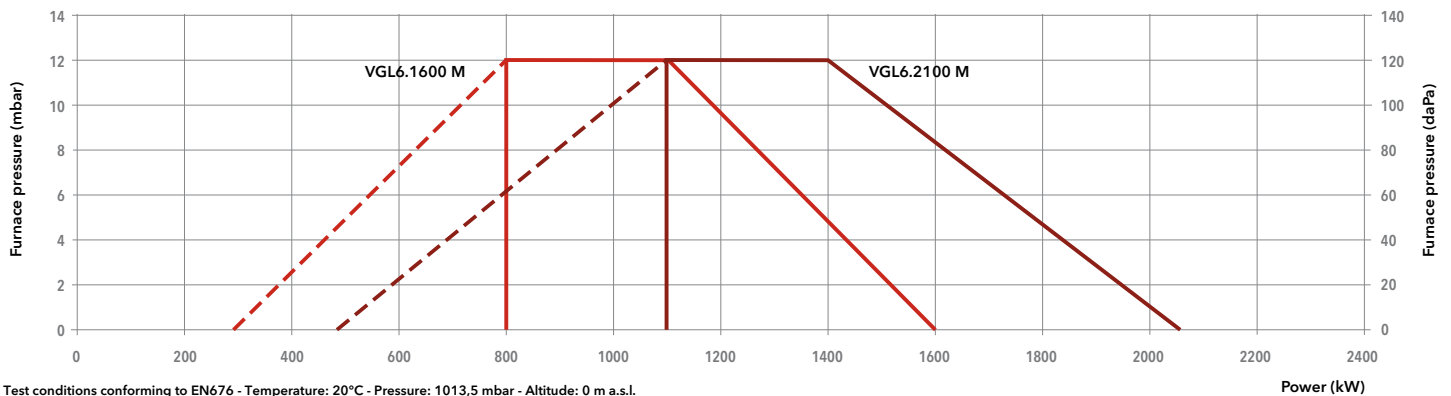

| Model | VGL6.1600 M /TC | | | VGL6.2100 M /TC | | | | |
|-------------------------------|----------------------------|----------------|---------|----------------------------|---------|---------|---------|---------|
| Operation range | (300) 800 - 1600 kW | | | (480) 1100 - 2050 kW | | | | |
| Gas pressure | 20 - 300 mbar | | | 20 - 300 mbar | | | | |
| Control box / flame detection | BT3... / QRA 2 | | | BT3... / QRA 2 | | | | |
| Fan motor | 230/400 V - 50 Hz - 2,2 kW | | | 230/400 V - 50 Hz - 2,5 kW | | | | |
| Electrical consumption | 2800 W | | | 3400 W | | | | |
| Acoustic level (LpA) | 77,2 dB(A) | | | 79 dB(A) | | | | |
| CE certificate | 1312 BM 3427 | | | 1312 BM 3428 | | | | |
| Head length | | KN | KL | KM | KN | KL | KM | |
| Complete | VGD 40-065 | s65-DN65/TC | 3836669 | 3836671 | 3836670 | 3836681 | 3836683 | 3836682 |
| burner code | MBC1900 | d65-DN65/TC | 3836672 | 3836674 | 3836673 | 3836684 | 3836686 | 3836685 |
| | MBC1200 | d2"-Rp2"/TC | 3836675 | 3836677 | 3836676 | 3836687 | 3836689 | 3836688 |
| | MBC700 | d1"1/2-Rp2"/TC | 3836678 | 3836680 | 3836679 | 3836690 | 3836692 | 3836691 |

OTHER AVAILABLE VERSIONS

 Versions for continuous ventilation and post-ventilation

SCOPE OF SUPPLY

The burner is delivered in its package complete with:

- 1 burner head with flange seal and securing screws
- 1 compact gas train with gas filter; the gas filter is built-in for threaded valves (up to 2") and separated for flanged ones (DN65/80/100)
- 1 bag containing installation fittings
- 1 bag containing technical documentation (instruction manual, technical data, electrical diagram, exploded view and spare parts list)



DIMENSIONS (mm)

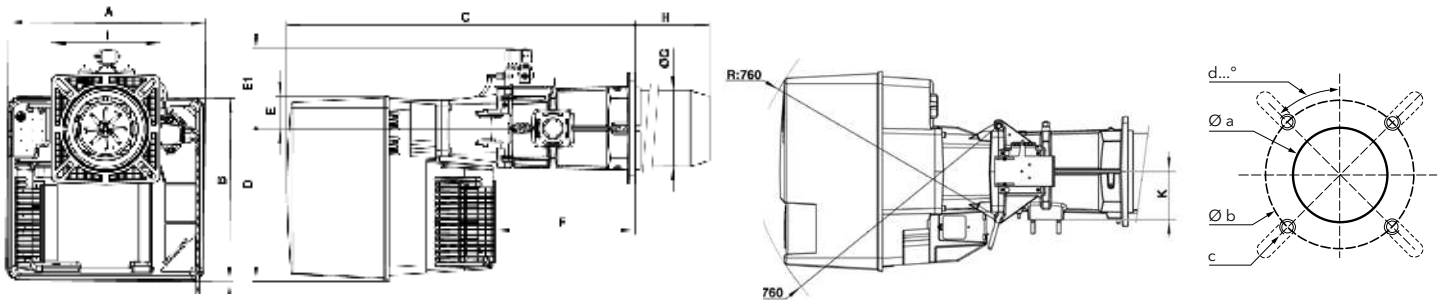

| A | B | C | D | E | E1 | F | ØG | H | | | I | K | N |
|-----|-----|------|-----|----|-----|-----|-----|-----|-----|-----|---------|-----|-----|
| | | | | | | | | KN | KM | KL | | | |
| 592 | 553 | 1050 | 456 | 97 | 239 | 421 | 227 | 270 | 370 | 470 | 326x335 | 144 | 247 |

| Øa (mm) | b (mm) | c | d |
|---------|---------|-----|-----|
| 250 | 300-400 | M12 | 45° |

Gas trains

Gas train "d":

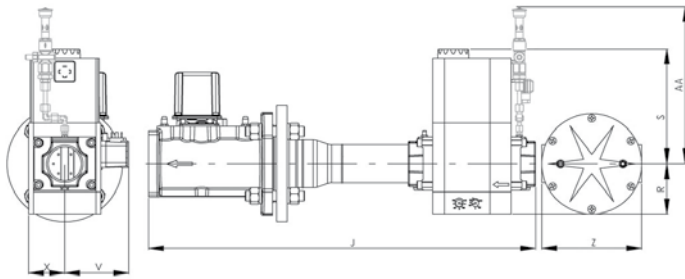

| Model | J | R | S | V | X | Z | AA* |
|-------------|-----|-----|-----|-----|----|-----|-----|
| d65-DN65 | 490 | 183 | 245 | 110 | 98 | 290 | 385 |
| d2"-Rp2" | 700 | 96 | 330 | 125 | 81 | - | 385 |
| d1"1/2-Rp2" | 622 | 80 | 185 | 102 | 57 | - | 320 |

Gas train "s":

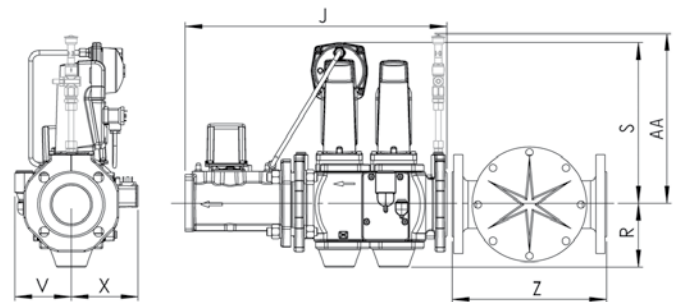

| Model | J | R | S | V | X | Z | AA* |
|----------|-----|-----|-----|-----|-----|-----|-----|
| s65-DN65 | 490 | 118 | 300 | 106 | 126 | 290 | 365 |

*: for PED configuration

PACKAGING

The burner is delivered on a pallet in three packages containing:

- burner housing
- combustion head
- gas train and filter

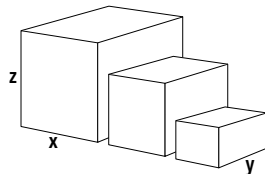

| Component | | Dimensions (mm) | | | Gross weight (kg) |
|-----------------|----------------|-----------------|-----|------|-------------------|
| | | X | Y | Z | |
| Burner body | VGL6.1600 M | 1200 | 800 | 1440 | 140 |
| | VGL6.2100 M | 1200 | 800 | 1440 | 140 |
| Combustion head | KN | 800 | 380 | 240 | 28 |
| | KL | 1000 | 380 | 420 | 30 |
| | KM | 1000 | 380 | 420 | 31 |
| Gas train | s65-DN65/TC | 790 | 600 | 500 | 29,4 |
| | d65-DN65/TC | 670 | 550 | 380 | 33 |
| | d2"-Rp2"/TC | 670 | 550 | 380 | 22 |
| | d1"1/2-Rp2"/TC | 670 | 550 | 380 | 21 |

VGL6.1600 M / VGL6.2100 M

300 ... 2050 kW

Two stage progressive/modulating electronic in gas / Three stages in oil

PRESSURE LOSS [BURNER HEAD + GAS TRAIN] (mbar)

VGL6.1600 M

| Burner output (kW) | Natural gas G20 Hi = 10,35 kWh/m ³ | | | | Natural gas G25 Hi = 8,83 kWh/m ³ | | | | LPG G31 Hi = 25,89 kWh/m ³ |
|--------------------|---|----------|----------|----------|--|----------|----------|----------|---------------------------------------|
| | d1"1/2-Rp2" | d2"-Rp2" | d65-DN65 | s65-DN65 | d1"1/2-Rp2" | d2"-Rp2" | d65-DN65 | s65-DN65 | d1"1/2-Rp2" |
| 800 | 16 | 9 | 6 | 6 | 22 | 12 | 8 | 8 | 8 |
| 1000 | 25 | 13 | 10 | 9 | 34 | 18 | 12 | 12 | 12 |
| 1200 | 35 | 18 | 14 | 13 | 48 | 24 | 18 | 18 | 17 |
| 1400 | 47 | 24 | 19 | 18 | 64 | 32 | 24 | 24 | 22 |
| 1600 | 61 | 31 | 25 | 23 | 83 | 42 | 31 | 31 | 29 |

Natural gas G20

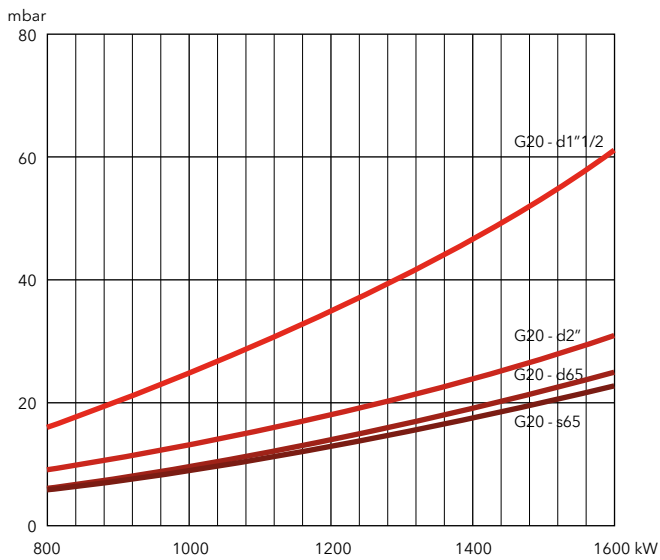

Natural gas G25

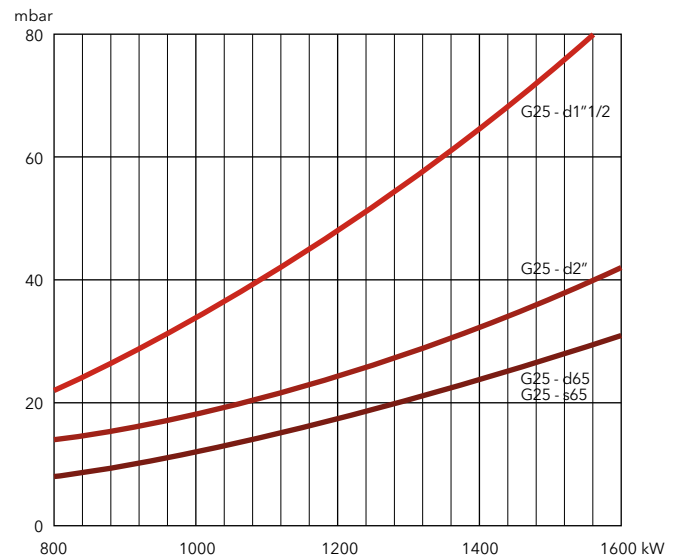

LPG

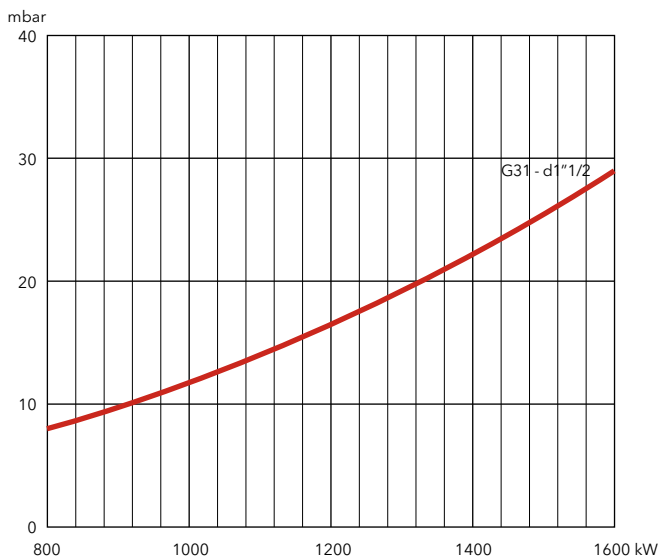



PRESSURE LOSS [BURNER HEAD + GAS TRAIN] (mbar)

VGL6.2100 M

| Burner output (kW) | Natural gas G20 Hi = 10,35 kWh/m ³ | | | | Natural gas G25 Hi = 8,83 kWh/m ³ | | | | LPG G31 Hi = 25,89 kWh/m ³ | |
|--------------------|---|----------|----------|----------|--|----------|----------|----------|---------------------------------------|----------|
| | d1"1/2-Rp2" | d2"-Rp2" | d65-DN65 | s65-DN65 | d1"1/2-Rp2" | d2"-Rp2" | d65-DN65 | s65-DN65 | d1"1/2-Rp2" | d2"-Rp2" |
| 1100 | 28 | 15 | 12 | 11 | 39 | 21 | 15 | 15 | 13 | 9 |
| 1300 | 39 | 21 | 16 | 16 | 54 | 29 | 21 | 22 | 18 | 11 |
| 1500 | 51 | 27 | 21 | 21 | 71 | 37 | 28 | 29 | 23 | 14 |
| 1700 | 64 | 34 | 27 | 27 | 91 | 47 | 36 | 37 | 29 | 17 |
| 1900 | 80 | 41 | 34 | 34 | 114 | 59 | 45 | 46 | 36 | 20 |

Natural gas G20

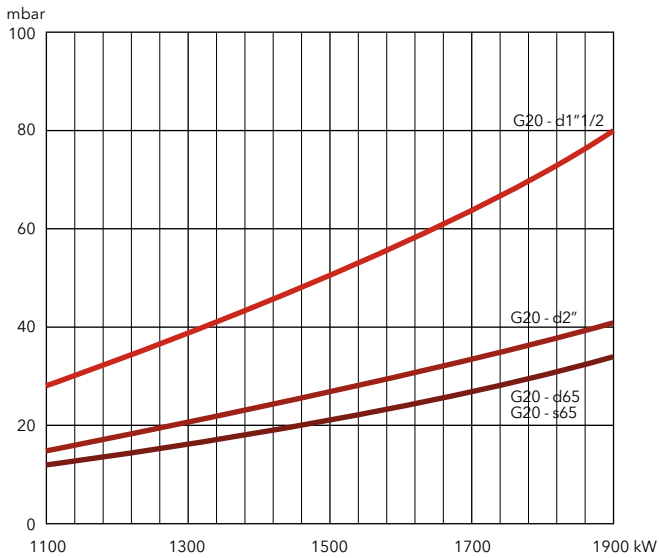

Natural gas G25

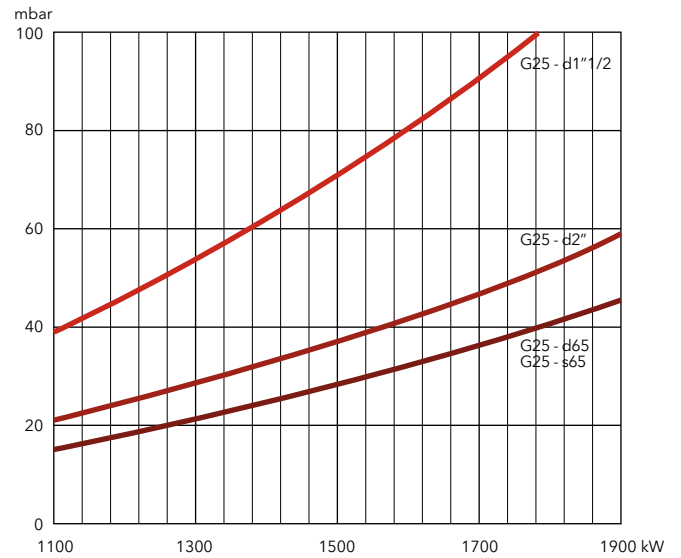

LPG

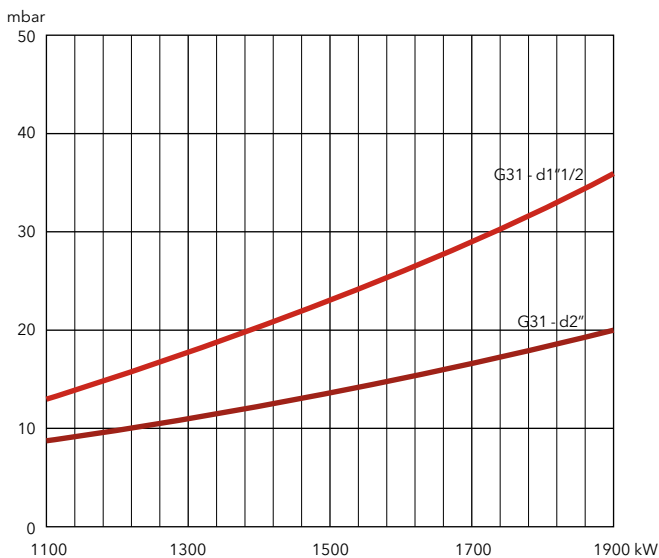

VGL5.700 M V / VGL5.1000 M V

200 ... 1000 kW

Two stage progressive/modulating electronic / Three stages + fan speed control

- **Fuels:** natural gas (G20/G25, $H_u = 8,83...10,35$ kWh/m³);
light oil (viscosity 6 mm²/s at 20°C, $H_u = 11,86$ kWh/kg)
- **Emissions:** Low NOx class 3 in gas (≤ 80 mg/kWh) according to EN676
Low NOx class 2 in light oil (≤ 185 mg/kWh) according to EN267
- **Operation:** two stage progressive or modulating with the installation of a power regulator and dedicated probes (see page 198) in gas and three stages in light oil
- **Protection level:** IP 41



TECHNICAL DATA

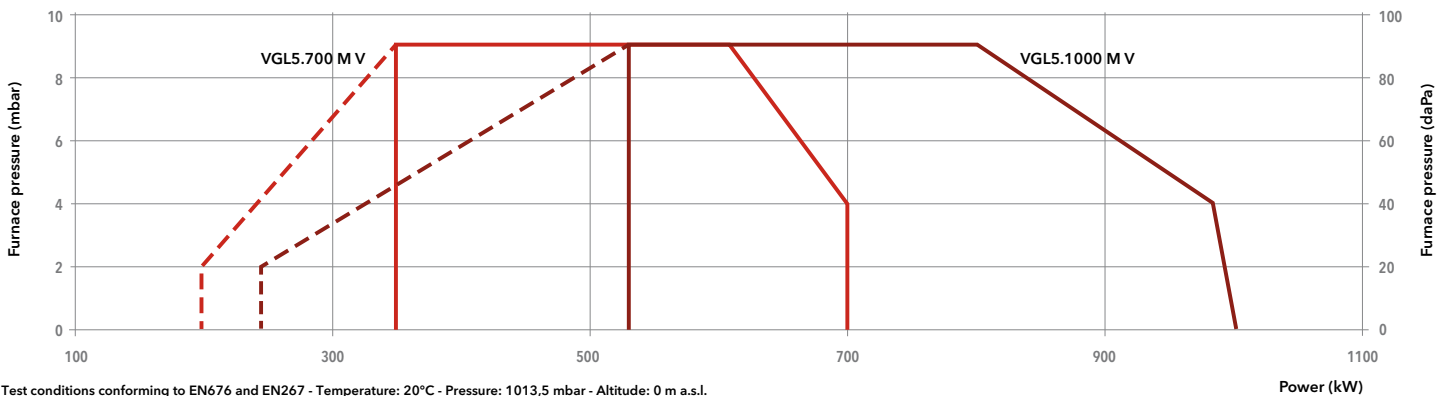

Test conditions conforming to EN676 and EN267 - Temperature: 20°C - Pressure: 1013,5 mbar - Altitude: 0 m a.s.l.

| Model | VGL5.700 M V /TC | | | VGL5.1000 M V /TC | | | | |
|-------------------------------|-------------------------------------|----------------|----------------|-------------------------------------|----------------|----------------|----------------|----------------|
| Operation range | (200) 350 – 700 kW | | | (240) 530 – 1000 kW | | | | |
| Gas pressure | 20 – 300 mbar | | | 20 – 300 mbar | | | | |
| Control box / flame detection | BT3... / QRA 2 | | | BT3... / QRA 2 | | | | |
| Fan motor | 230/400 V – 50 Hz – 1,1 kW | | | 230/400 V – 50 Hz – 1,5 kW | | | | |
| Nozzle | 4,5 US gal/h 45°B / 5 US gal/h 45°B | | | 5 US gal/h 45°B / 8,5 US gal/h 45°B | | | | |
| Electrical consumption | 2000 W | | | 2200 W | | | | |
| Acoustic level (LpA) | 78 dB(A) | | | 81 dB(A) | | | | |
| CE certificate | 1312 AQ 924 | | | 1312 AQ 925 | | | | |
| Head length | | KN | KL | KM | KN | KL | KM | |
| Complete burner code | VGD 40-065 | s65-DN65 | - | - | - | 3836702 | 3836704 | 3836703 |
| | MBC1900 | d65-DN65 | - | - | - | 3836705 | 3836707 | 3836706 |
| | MBC1200 | d2"-Rp2" | 3836693 | 3836695 | 3836694 | 3836708 | 3836710 | 3836709 |
| | MBC700 | d1 1/2"-Rp2" | 3836696 | 3836698 | 3836697 | 3836711 | 3836713 | 3836712 |
| | MBC300 | d3/4"-Rp1 1/4" | 3836699 | 3836701 | 3836700 | 3836714 | 3836716 | 3836715 |

OTHER AVAILABLE VERSIONS

 Versions for continuous ventilation and post-ventilation

SCOPE OF SUPPLY

The burner is delivered in its package complete with:

- 1 burner head with flange seal and securing screws
- 1 compact gas train with gas filter; the gas filter is built-in for threaded valves (up to 2") and separated for flanged ones (DN65/80/100)
- 1 bag containing installation fittings
- 1 bag containing technical documentation (instruction manual, technical data, electrical diagram, exploded view and spare parts list)



DIMENSIONS (mm)

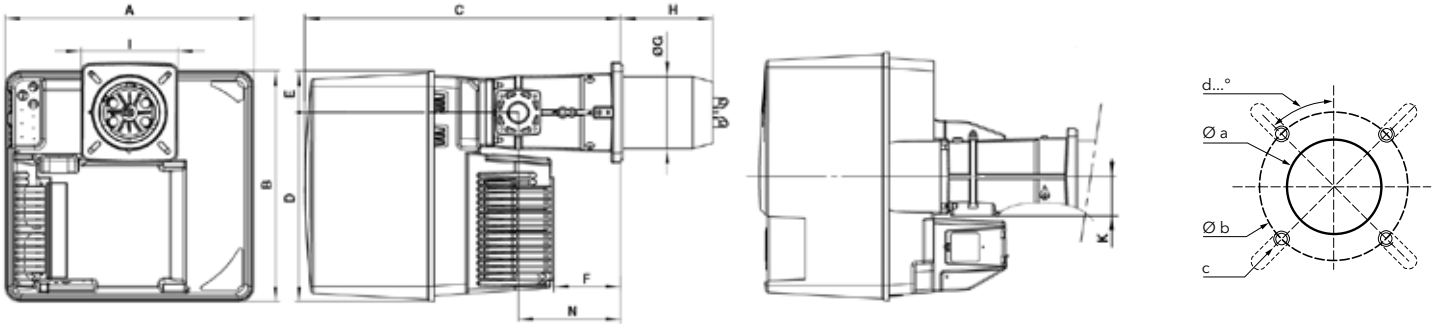

| A | B | C | D | E | F | ØG | H | | | I | K | N |
|-----|-----|-----|-----|----|-----|-----|-----|-----|-----|---------|----|-----|
| | | | | | | | KN | KM | KL | | | |
| 581 | 549 | 752 | 450 | 99 | 164 | 170 | 215 | 325 | 435 | 230x238 | 89 | 244 |

| Øa (mm) | b (mm) | c | d |
|---------|---------|-----|-----|
| 195 | 220-260 | M10 | 45° |

Gas trains

Gas train "d":

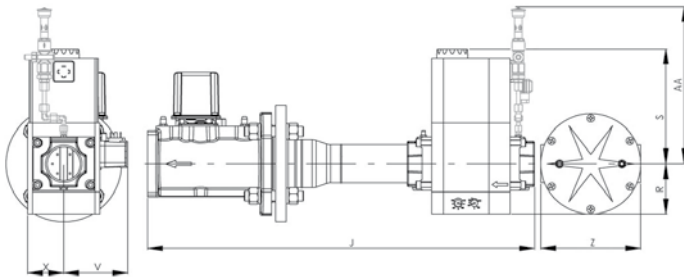

| Model | J | R | S | V | X | Z | AA* |
|---------------|-----|-----|-----|-----|----|-----|-----|
| d65-DN65 | 490 | 183 | 245 | 110 | 98 | 290 | 385 |
| d2"-Rp2" | 700 | 96 | 330 | 125 | 81 | - | 385 |
| d1"1/2-Rp2" | 622 | 80 | 185 | 102 | 57 | - | 320 |
| d3/4"-Rp1"1/4 | 460 | 60 | 173 | 88 | 58 | - | 320 |

Gas train "s":

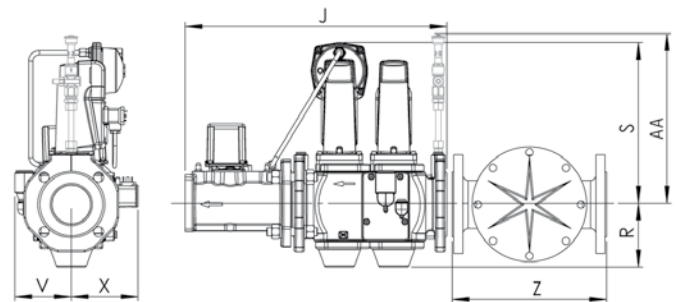

| Model | J | R | S | V | X | Z | AA* |
|----------|-----|-----|-----|-----|-----|-----|-----|
| s65-DN65 | 490 | 118 | 300 | 106 | 126 | 290 | 365 |

*: for PED configuration

PACKAGING

The burner is delivered on a pallet in three packages containing:

- burner housing
- combustion head
- gas train and filter

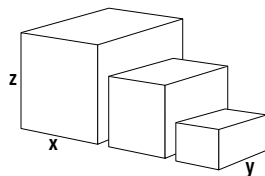

| Component | | Dimensions (mm) | | | Gross weight (kg) |
|-----------------|------------------|-----------------|-----|-----|-------------------|
| | | X | Y | Z | |
| Burner body | VGL5.700 M V | 800 | 600 | 850 | 70 |
| | VGL5.1000 M V | 800 | 600 | 850 | 70 |
| Combustion head | KN | 780 | 265 | 280 | 13 |
| | KL | 1010 | 265 | 280 | 16 |
| | KM | 1010 | 265 | 280 | 15 |
| Gas train | s65-DN65/TC | 670 | 530 | 380 | 26 |
| | d65-DN65/TC | 670 | 530 | 380 | 17 |
| | d2"-Rp2"/TC | 670 | 530 | 380 | 12 |
| | d1"1/2-Rp2"/TC | 670 | 530 | 380 | 12 |
| | d3/4"-Rp1"1/4/TC | 600 | 400 | 240 | 7 |

VGL5.700 M V / VGL5.1000 M V

200 ... 1000 kW

Two stage progressive/modulating electronic / Three stages + fan speed control

PRESSURE LOSS [BURNER HEAD + GAS TRAIN] (mbar)

VGL5.700 M V

| Burner output (kW) | Natural gas G20 Hi = 10,35 kWh/m ³ | | | Natural gas G25 Hi = 8,83 kWh/m ³ | | | LPG G31 |
|--------------------|---|-------------|----------|--|-------------|----------|-------------|
| | d3/4-Rp1"1/4 | d1"1/2-Rp2" | d2"-Rp2" | d3/4-Rp1"1/4 | d1"1/2-Rp2" | d2"-Rp2" | d1"1/2-Rp2" |
| 500 | 31 | 9 | 8 | 37 | 11 | 9 | 6 |
| 550 | 35 | 11 | 9 | 45 | 13 | 10 | 7 |
| 600 | 43 | 13 | 10 | 53 | 16 | 12 | 8 |
| 650 | 49 | 15 | 11 | 62 | 18 | 13 | 9 |
| 700 | 58 | 17 | 13 | 73 | 21 | 15 | 10 |

Natural gas G20

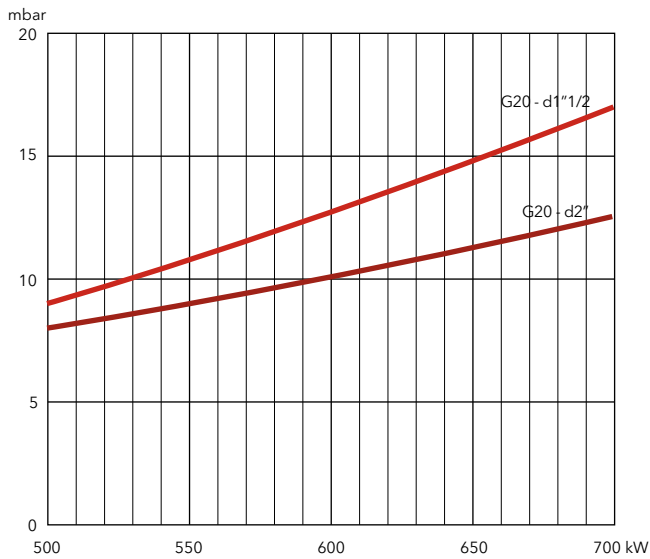

Natural gas G25

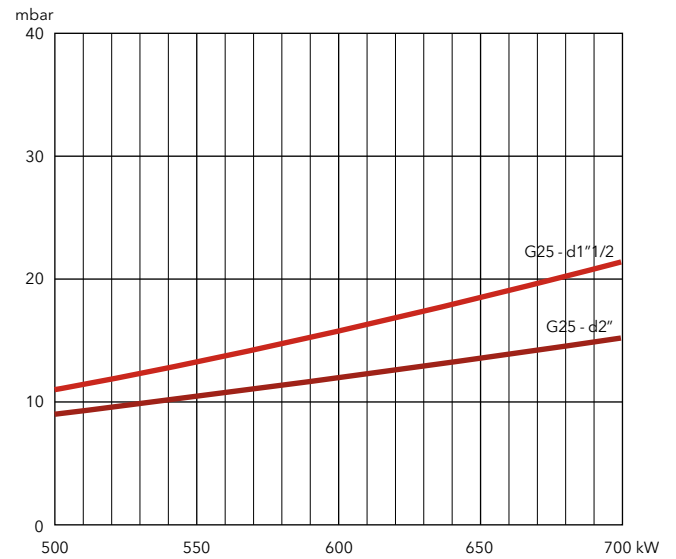

Natural gas G20, G25

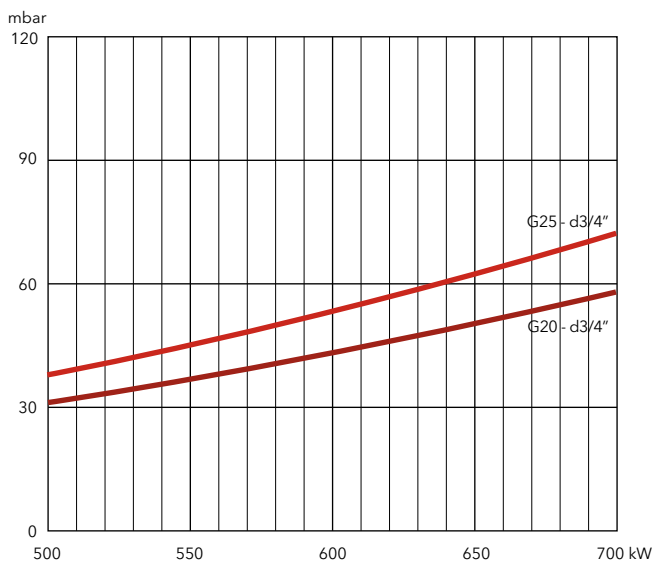

LPG

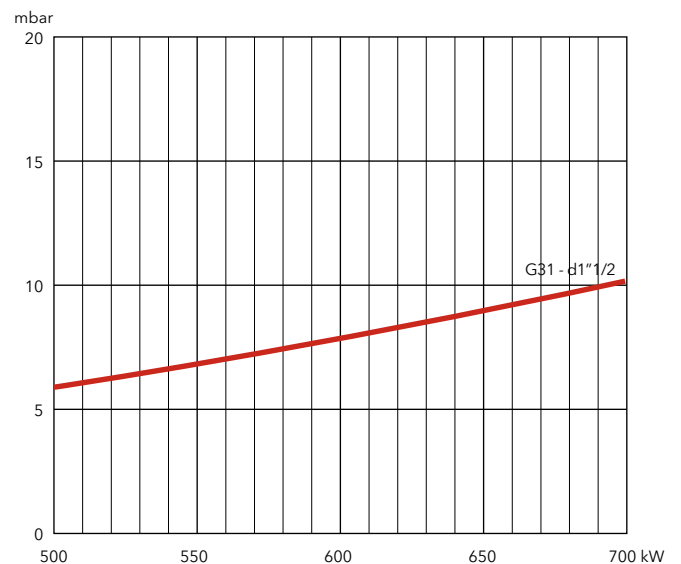



PRESSURE LOSS [BURNER HEAD + GAS TRAIN] (mbar)

VGL5.1000 M V

| Burner output (kW) | Natural gas G20 Hi = 10,35 kWh/m ³ | | | | | Natural gas G25 Hi = 8,83 kWh/m ³ | | | | | LPG G31 |
|--------------------|---|-------------|----------|----------|----------|--|-------------|----------|----------|----------|-------------|
| | d3/4-Rp1"1/4 | d1"1/2-Rp2" | d2"-Rp2" | d65-DN65 | s65-DN65 | d3/4-Rp1"1/4 | d1"1/2-Rp2" | d2"-Rp2" | d65-DN65 | s65-DN65 | d1"1/2-Rp2" |
| 700 | 40 | 16 | 12 | 10 | 10 | 60 | 21 | 14 | 10 | 12 | 10 |
| 800 | 53 | 20 | 14 | 13 | 13 | 79 | 27 | 17 | 13 | 15 | 12 |
| 900 | 68 | 25 | 17 | 16 | 16 | 100 | 34 | 21 | 16 | 19 | 15 |
| 1000 | 84 | 31 | 21 | 20 | 20 | 126 | 42 | 26 | 20 | 24 | 18 |

Natural gas G20

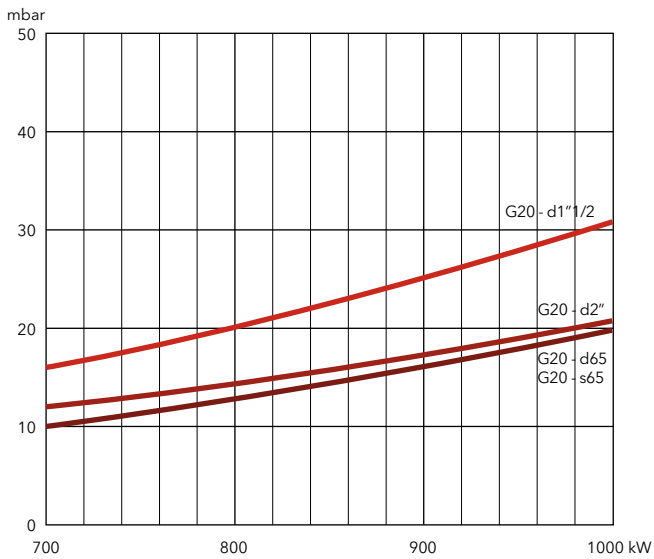

Natural gas G25

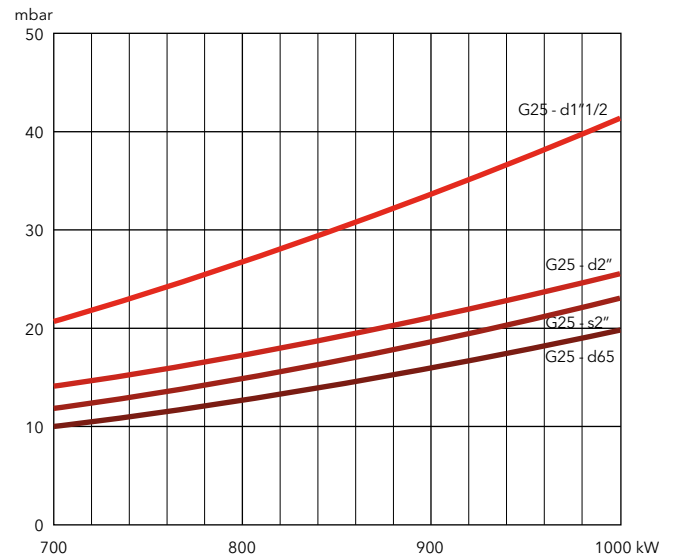

Natural gas G20, G25

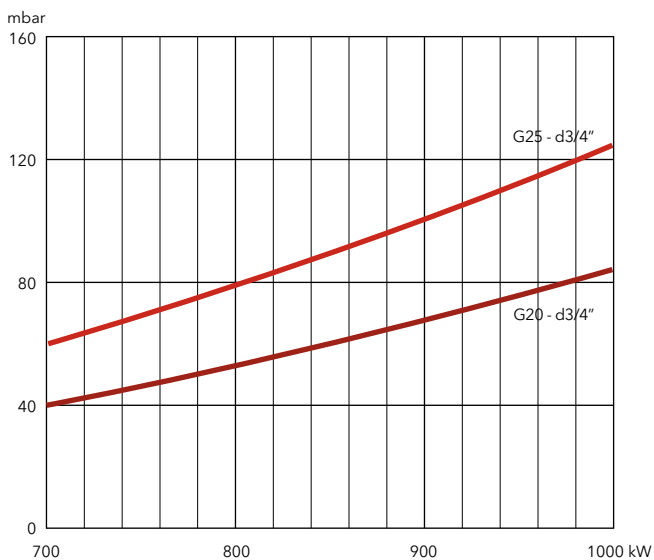

LPG

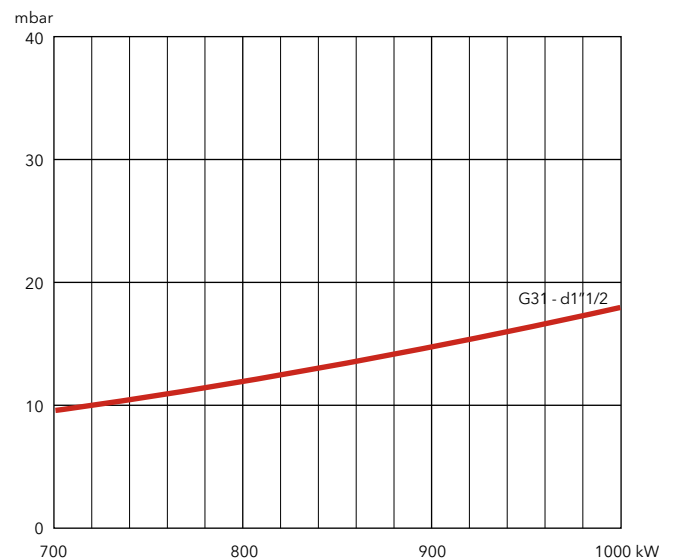

VGL6.1600 M V / VGL6.2100 M V

300 ... 2050 kW

Two stage progressive/modulating electronic / Three stages + fan speed control

- **Fuels:** natural gas (G20/G25, $H_u = 8,83...10,35 \text{ kWh/m}^3$);
light oil (viscosity $6 \text{ mm}^2/\text{s}$ at 20°C , $H_u = 11,86 \text{ kWh/kg}$)
- **Emissions:** Low NOx class 3 in gas ($\leq 80 \text{ mg/kWh}$) according to EN676
Low NOx class 2 in light oil ($\leq 185 \text{ mg/kWh}$) according to EN267
- **Operation:** two stage progressive or modulating with the installation of a power regulator and dedicated probes (see page 198) in gas and three stages in light oil
- **Protection level:** IP 41



TECHNICAL DATA

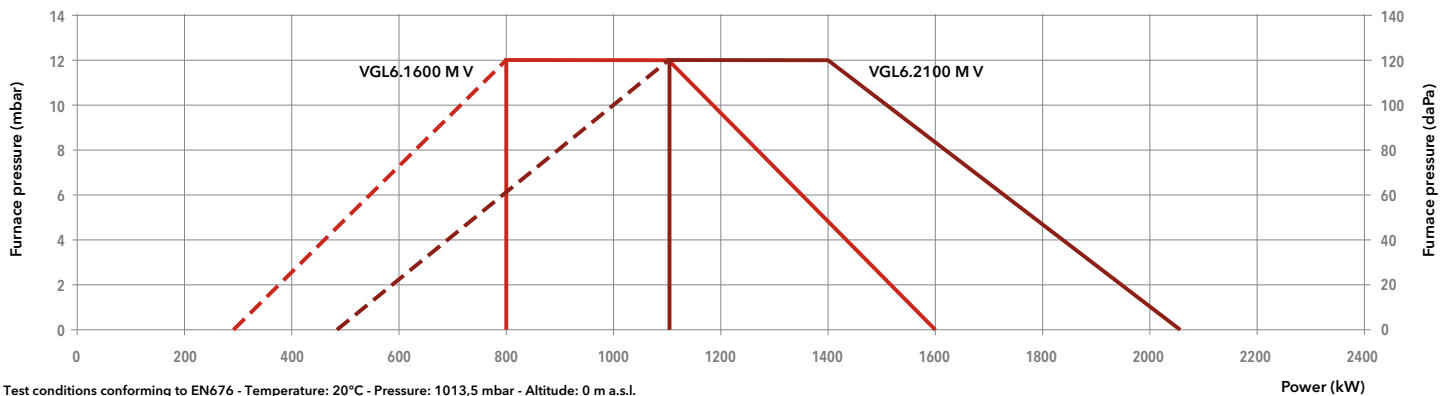

Test conditions conforming to EN676 - Temperature: 20°C - Pressure: 1013,5 mbar - Altitude: 0 m a.s.l.

| Model | VGL6.1600 M V /TC | | | VGL6.2100 M V /TC | | | | |
|-------------------------------|----------------------------|----------------|----------------|----------------------------|----------------|----------------|----------------|----------------|
| Operation range | (300) 800 - 1600 kW | | | (480) 1100 - 2050 kW | | | | |
| Gas pressure | 20 - 300 mbar | | | 20 - 300 mbar | | | | |
| Control box / flame detection | BT3... / QRA 2 | | | BT3... / QRA 2 | | | | |
| Fan motor | 230/400 V - 50 Hz - 2,2 kW | | | 230/400 V - 50 Hz - 2,5 kW | | | | |
| Electrical consumption | 2800 W | | | 3400 W | | | | |
| Acoustic level (LpA) | 77,2 dB(A) | | | 79 dB(A) | | | | |
| CE certificate | 1312 BM 3427 | | | 1312 BM 3428 | | | | |
| Head length | | KN | KL | KM | KN | KL | KM | |
| Complete | VGD 40-065 | s65-DN65/TC | 3836717 | 3836719 | 3836718 | 3836729 | 3836731 | 3836730 |
| burner code | MBC1900 | d65-DN65/TC | 3836720 | 3836722 | 3836721 | 3836732 | 3836734 | 3836733 |
| | MBC1200 | d2"-Rp2"/TC | 3836723 | 3836725 | 3836724 | 3836735 | 3836737 | 3836736 |
| | MBC700 | d1"1/2-Rp2"/TC | 3836726 | 3836728 | 3836727 | 3836738 | 3836740 | 3836739 |

OTHER AVAILABLE VERSIONS

 Versions for continuous ventilation and post-ventilation

SCOPE OF SUPPLY

The burner is delivered in its package complete with:

- 1 burner head with flange seal and securing screws
- 1 compact gas train with gas filter; the gas filter is built-in for threaded valves (up to 2") and separated for flanged ones (DN65/80/100)
- 1 bag containing installation fittings
- 1 bag containing technical documentation (instruction manual, technical data, electrical diagram, exploded view and spare parts list)



DIMENSIONS (mm)

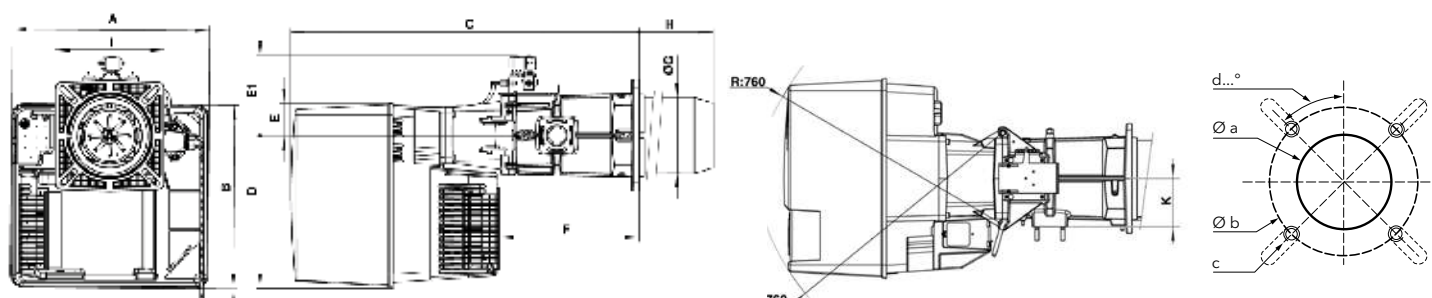

| A | B | C | D | E | E1 | F | ØG | H | | | I | K | N |
|-----|-----|------|-----|----|-----|-----|-----|-----|-----|-----|---------|-----|-----|
| | | | | | | | | KN | KM | KL | | | |
| 592 | 553 | 1050 | 456 | 97 | 239 | 421 | 227 | 270 | 370 | 470 | 326x335 | 144 | 247 |

| Øa (mm) | b (mm) | c | d |
|---------|---------|-----|-----|
| 250 | 300-400 | M12 | 45° |

Gas trains

Gas train "d":

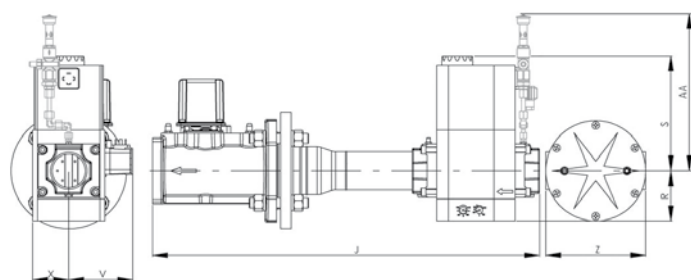

| Model | J | R | S | V | X | Z | AA* |
|-------------|-----|-----|-----|-----|----|-----|-----|
| d65-DN65 | 490 | 183 | 245 | 110 | 98 | 290 | 385 |
| d2"-Rp2" | 700 | 96 | 330 | 125 | 81 | - | 385 |
| d1"1/2-Rp2" | 622 | 80 | 185 | 102 | 57 | - | 320 |

Gas train "s":

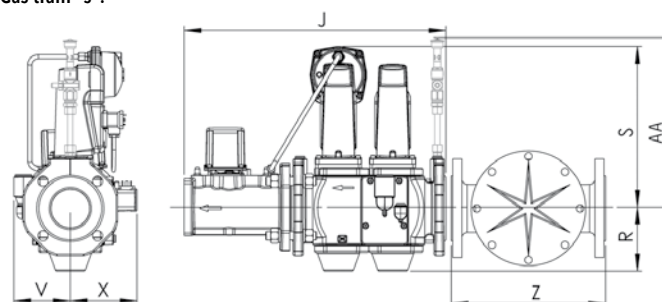

| Model | J | R | S | V | X | Z | AA* |
|----------|-----|-----|-----|-----|-----|-----|-----|
| s65-DN65 | 490 | 118 | 300 | 106 | 126 | 290 | 365 |

*: for PED configuration

PACKAGING

The burner is delivered on a pallet in three packages containing:

- burner housing
- combustion head
- gas train and filter

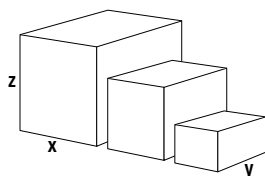

| Component | | Dimensions (mm) | | | Gross weight (kg) |
|-----------------|----------------|-----------------|-----|------|-------------------|
| | | X | Y | Z | |
| Burner body | VGL6.1600 M V | 1200 | 800 | 1440 | 140 |
| | VGL6.2100 M V | 1200 | 800 | 1440 | 140 |
| Combustion head | KN | 800 | 380 | 240 | 28 |
| | KL | 1000 | 380 | 420 | 30 |
| | KM | 1000 | 380 | 420 | 31 |
| Gas train | s65-DN65/TC | 670 | 530 | 380 | 26 |
| | d65-DN65/TC | 670 | 530 | 380 | 17 |
| | d2"-Rp2"/TC | 670 | 530 | 380 | 12 |
| | d1"1/2-Rp2"/TC | 670 | 530 | 380 | 12 |

VGL6.1600 M V / VGL6.2100 M V

300 ... 2050 kW

Two stage progressive/modulating electronic / Three stages + fan speed control

PRESSURE LOSS [BURNER HEAD + GAS TRAIN] (mbar)

VGL6.1600 M V

| Burner output (kW) | Natural gas G20 Hi = 10,35 kWh/m ³ | | | | Natural gas G25 Hi = 8,83 kWh/m ³ | | | | LPG G31 Hi = 25,89 kWh/m ³ |
|--------------------|---|----------|----------|----------|--|----------|----------|----------|---------------------------------------|
| | d1"1/2-Rp2" | d2"-Rp2" | d65-DN65 | s65-DN65 | d1"1/2-Rp2" | d2"-Rp2" | d65-DN65 | s65-DN65 | d1"1/2-Rp2" |
| 800 | 16 | 9 | 6 | 6 | 22 | 12 | 8 | 8 | 8 |
| 1000 | 25 | 13 | 10 | 9 | 34 | 18 | 12 | 12 | 12 |
| 1200 | 35 | 18 | 14 | 13 | 48 | 24 | 18 | 18 | 17 |
| 1400 | 47 | 24 | 19 | 18 | 64 | 32 | 24 | 24 | 22 |
| 1600 | 61 | 31 | 25 | 23 | 83 | 42 | 31 | 31 | 29 |

Natural gas G20

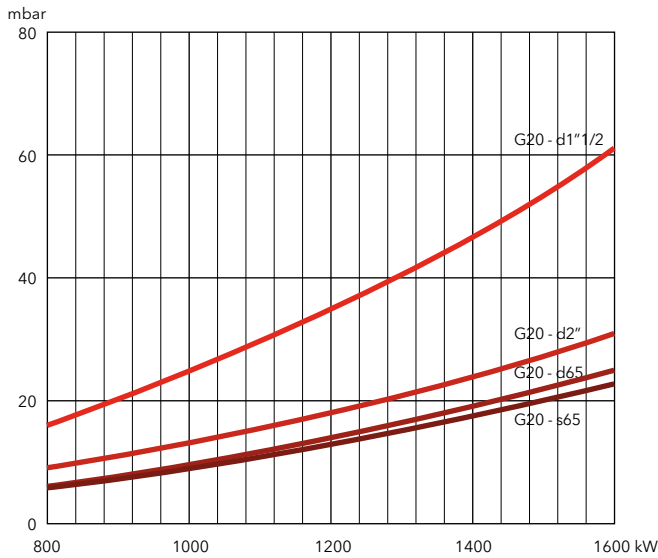

Natural gas G25

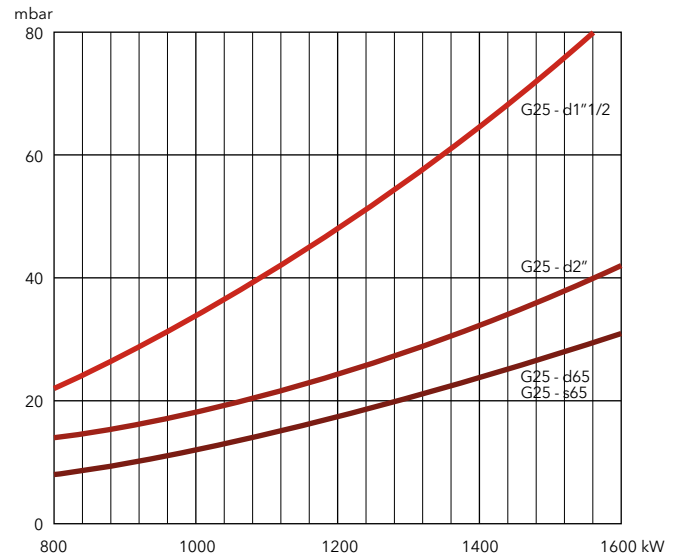

LPG

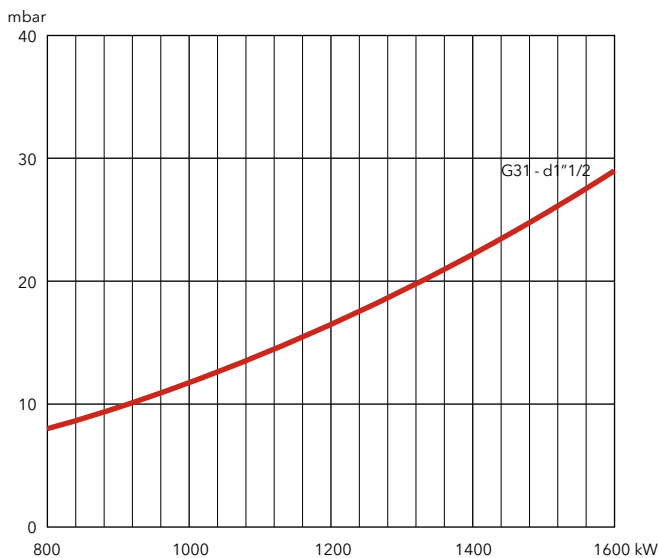



PRESSURE LOSS [BURNER HEAD + GAS TRAIN] (mbar)

VGL6.2100 M V

| Burner output (kW) | Natural gas G20 Hi = 10,35 kWh/m ³ | | | | Natural gas G25 Hi = 8,83 kWh/m ³ | | | | LPG G31 Hi = 25,89 kWh/m ³ | |
|--------------------|---|----------|----------|----------|--|----------|----------|----------|---------------------------------------|----------|
| | d1"1/2-Rp2" | d2"-Rp2" | d65-DN65 | s65-DN65 | d1"1/2-Rp2" | d2"-Rp2" | d65-DN65 | s65-DN65 | d1"1/2-Rp2" | d2"-Rp2" |
| 1100 | 28 | 15 | 12 | 11 | 39 | 21 | 15 | 15 | 13 | 9 |
| 1300 | 39 | 21 | 16 | 16 | 54 | 29 | 21 | 22 | 18 | 11 |
| 1500 | 51 | 27 | 21 | 21 | 71 | 37 | 28 | 29 | 23 | 14 |
| 1700 | 64 | 34 | 27 | 27 | 91 | 47 | 36 | 37 | 29 | 17 |
| 1900 | 80 | 41 | 34 | 34 | 114 | 59 | 45 | 46 | 36 | 20 |

Natural gas G20

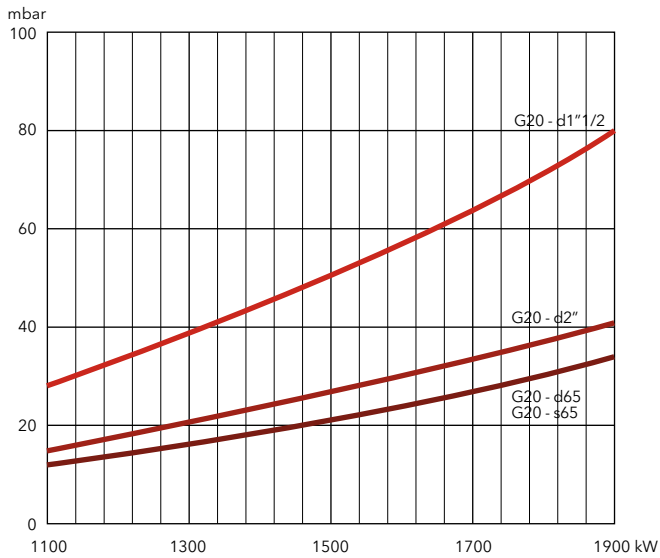

Natural gas G25

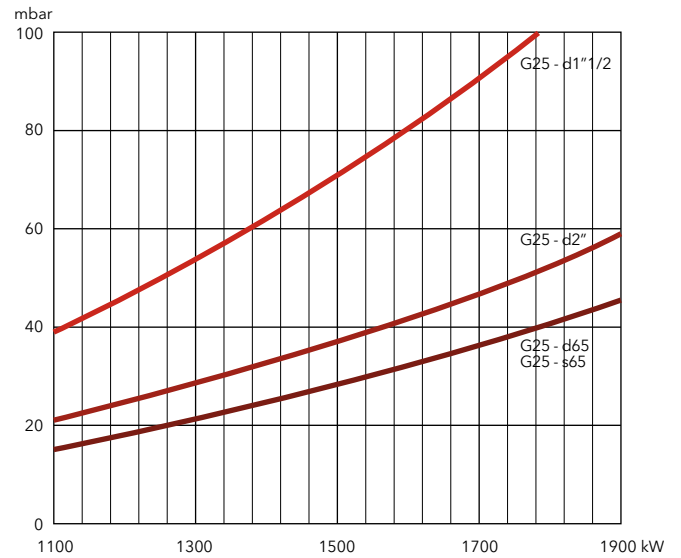

LPG

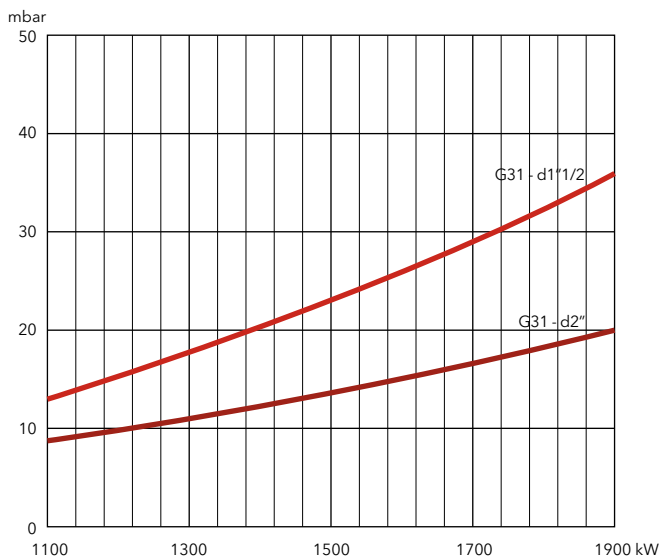

VE1.34 / VE1.50 / VE1.75

16 ... 75 kW
One stage (Yellow Flame)

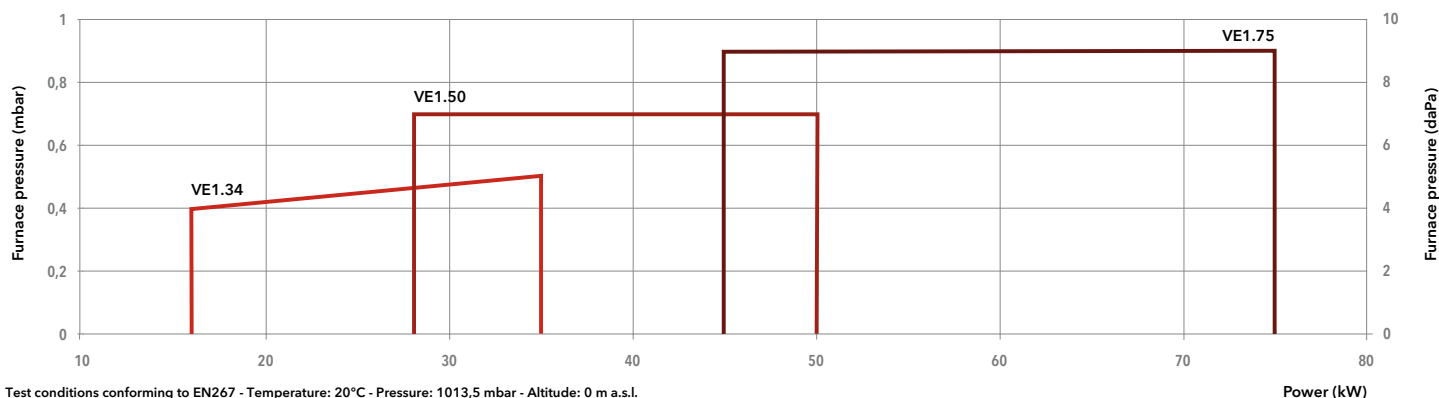

- **Fuel:** light oil (viscosity 6 mm²/s at 20°C, H_v = 11,86 kWh/kg)
- **Emissions:** NO_x < 100 mg/kWh (NCV), burners compliant with ErP Directive
- **Protection level:** IP 21

TECHNICAL DATA

| Model | VE1.34 | VE1.50 | VE1.75 |
|-------------------------------|-------------------------------|-------------------------------|-------------------------------|
| Operation range | 16 - 34 kW | 28 - 50 kW | 44 - 75 kW |
| Fuel flow | 1,3 - 2,8 kg/h | 2,4 - 4,2 kg/h | 3,7 - 6,3 kg/h |
| Nozzle | 0,45 US gal/h 45°S | 0,75 US gal/h 45°S | 1,10 US gal/h 45°H |
| Control box / flame detection | TCH 141.03 / QRB1 | TCH 141.03 / QRB1 | TCH 141.00 / QRB1 |
| Fan motor | 230 V - 50 Hz - 110 W | 230 V - 50 Hz - 110 W | 230 V - 50 Hz - 110 W |
| Electrical consumption | 244 W | 244 W | 233 W |
| Flexible hoses | Rp 3/8" / M14 x 1,5 - 1000 mm | Rp 3/8" / M14 x 1,5 - 1000 mm | Rp 3/8" / M14 x 1,5 - 1000 mm |
| Acoustic level (LpA) | 56 dB(A) | 56 dB(A) | 56 dB(A) |
| Head length | KN | KN | KN |
| Complete burner code | 3832630 | 3832632 | 3832634 |

OTHER AVAILABLE VERSIONS

 Versions for continuous ventilation and post-ventilation

SCOPE OF SUPPLY

The burner is delivered in its package complete with:

- 1 setting template
- 1 burner flange with insulation
- 1 bag containing installation fittings
- 1 bag containing technical documentation (instruction manual, technical data, electrical diagram, exploded view and spare parts list)



DIMENSIONS (mm)

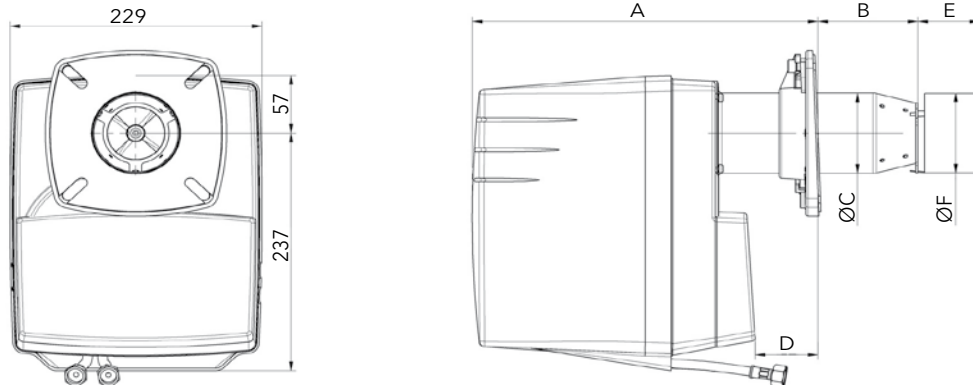

| Model | A | B | ØC | D | E | ØF |
|--------|-------------|------------|----|-----------|----|----|
| VE1.34 | 264 ... 329 | 70 ... 135 | 80 | 12 ... 77 | 63 | 79 |
| VE1.50 | 264 ... 344 | 70 ... 150 | 90 | 12 ... 92 | 56 | 84 |
| VE1.75 | 297 ... 357 | 70 ... 138 | 90 | 15 ... 83 | 56 | 84 |

Connecting flange

| Øa (mm) | b (mm) | c | d |
|---------|---------|----|-----|
| 95-104 | 150-170 | M8 | 45° |

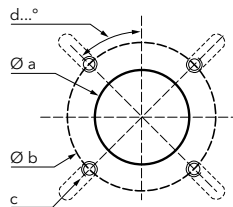

PACKAGING

The burner is delivered in a single package containing all the components

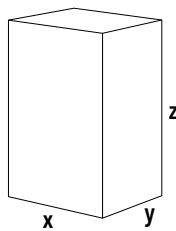

| Burner | Dimensions (mm) | | | Gross weight (kg) |
|--------|-----------------|-----|-----|-------------------|
| | X | Y | Z | |
| VE1.34 | 300 | 260 | 650 | 11 |
| VE1.50 | 300 | 260 | 650 | 11 |
| VE1.75 | 300 | 260 | 650 | 12 |

VE2.100 D / VE2.150 D

50 ... 150 kW
Two stages (Yellow Flame)

- **Fuel:** light oil (viscosity 6 mm²/s at 20°C, H_v = 11,86 kWh/kg)
- **Emissions:** NO_x < 100 mg/kWh (NCV), burners compliant with ErP Directive
- **Protection level:** IP 21

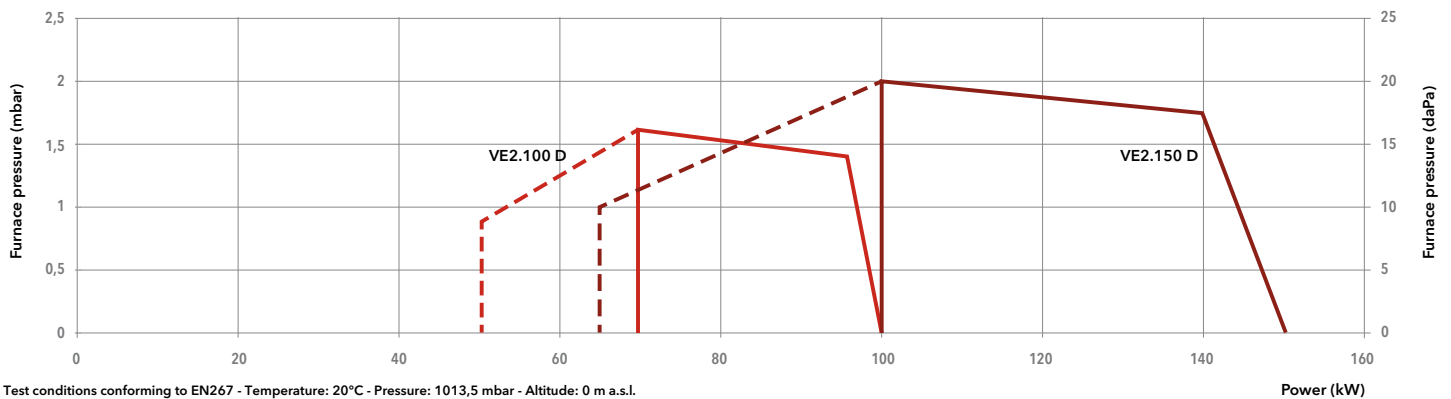
**TECHNICAL DATA**

| Model | VE2.100 D | VE2.150 D |
|-------------------------------|-------------------------------|-------------------------------|
| Operation range | (50) 70 - 100 kW | (65) 100 - 150 kW |
| Fuel flow | (4,2) 5,9 - 8,4 kg/h | (5,5) 8,4 - 12,6 kg/h |
| Nozzle | 1,25 US gal/h 45°H | 2,00 US gal/h 45°H |
| Control box / flame detection | TCH2... / QRB1 | TCH2... / QRB1 |
| Fan motor | 230 V - 50 Hz - 130 W | 230 V - 50 Hz - 130 W |
| Electrical consumption | 325 W | 325 W |
| Flexible hoses | Rp 3/8" / DN6 x 1,5 - 1500 mm | Rp 3/8" / DN6 x 1,5 - 1500 mm |
| Acoustic level (LpA) | 66,5 dB(A) | 66,5 dB(A) |
| Head length | KL | KL |
| Complete burner code | 3833101 | 3833102 |

OTHER AVAILABLE VERSIONS

 Versions for continuous ventilation and post-ventilation

SCOPE OF SUPPLY

The burner is delivered in its package complete with:

- 1 setting template
- 1 burner flange with insulation
- 1 bag containing installation fittings
- 1 bag containing technical documentation (instruction manual, technical data, electrical diagram, exploded view and spare parts list)



DIMENSIONS (mm)

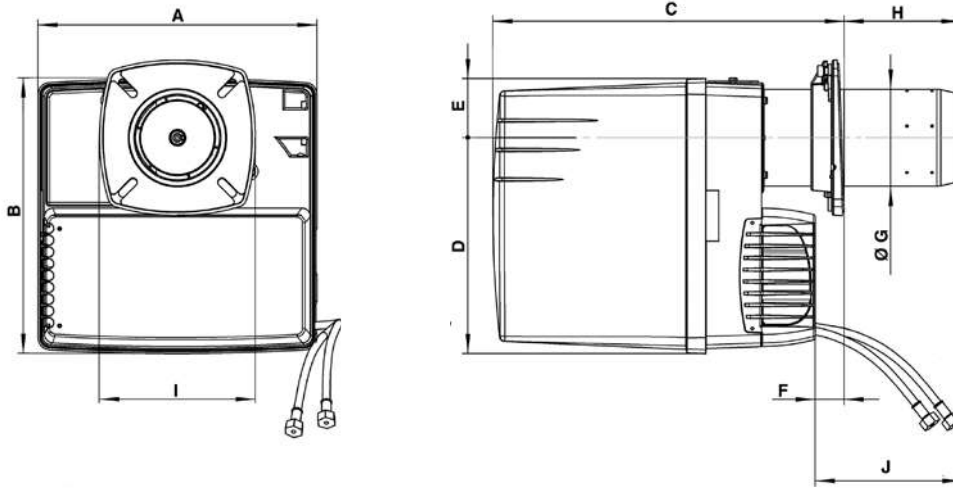

| Model | A | B | C | D | E | F min | ØG | H max | I | J |
|---------|-----|-----|-----------|-----|-----|-------|-----|-------|-----|-----|
| | | | KL | | | | | KL | | |
| VE2.100 | 331 | 326 | 398...638 | 256 | 133 | 15 | 115 | 264 | 185 | 700 |
| VE2.150 | 331 | 326 | 398...638 | 256 | 133 | 15 | 115 | 264 | 185 | 700 |

Connecting flange

| Øa (mm) | b (mm) | c | d |
|---------|---------|----|-----|
| 120-135 | 150-180 | M8 | 45° |

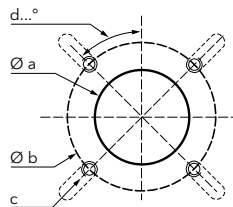

PACKAGING

The burner is delivered in a single package containing all the components

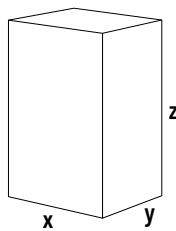

| Burner | Dimensions (mm) | | | Gross weight (kg) |
|-----------|-----------------|-----|-----|-------------------|
| | X | Y | Z | |
| VE2.100 D | 400 | 400 | 760 | 18 |
| VE2.150 D | 400 | 400 | 760 | 18 |

VB1.20 / VB1.24 / VB1.28 / VB1.30 / VB1.35

11 ... 35 kW
One stage (Blue Flame)

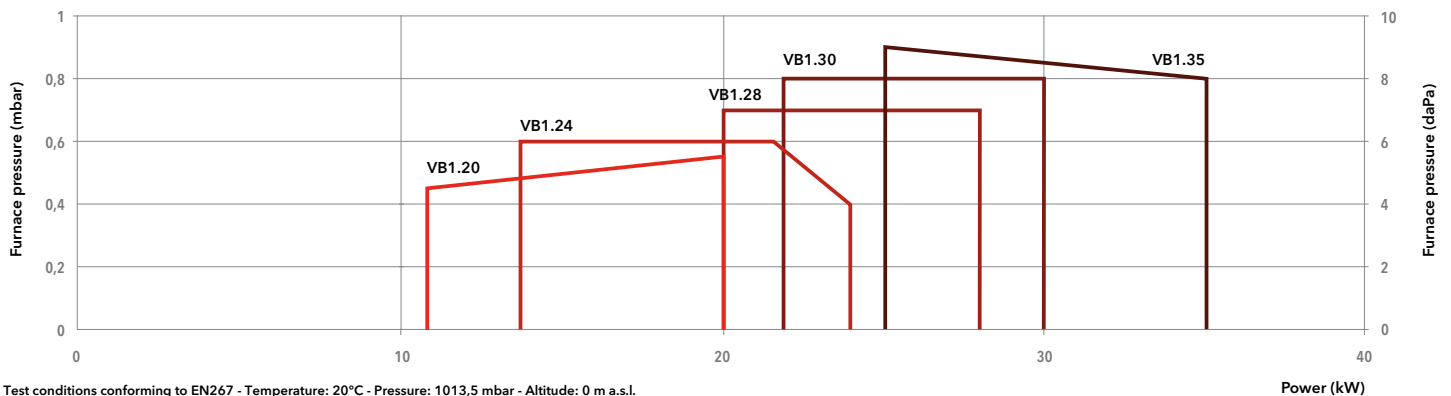

- **Fuel:** light oil (viscosity 6 mm²/s at 20°C, H_v = 11,86 kWh/kg)
- **Emissions:** NO_x < 100 mg/kWh (NCV), burners compliant with ErP Directive
- **Protection level:** IP 21

TECHNICAL DATA

| Model | VB1.20 | VB1.24 | VB1.28 | VB1.30 | VB1.35 |
|--------------------------------------|-------------------------------|-----------------------|-----------------------|-----------------------|-----------------------|
| Operation range | 11 - 20 kW | 14 - 24 kW | 20 - 28 kW | 22 - 30 kW | 25 - 35 kW |
| Fuel flow | 0,9 - 1,7 kg/h | 1,2 - 2,0 kg/h | 1,7 - 2,4 kg/h | 1,9 - 2,5 kg/h | 2,1 - 3,0 kg/h |
| Nozzle | 0,40 US gal/h 60°S | 0,45 US gal/h 60°S | 0,50 US gal/h 80°S | 0,55 US gal/h 80°S | 0,60 US gal/h 80°S |
| Control box / flame detection | TCH 141.03 / IRD 1010 | TCH 141.03 / IRD 1010 | TCH 141.03 / IRD 1010 | TCH 141.03 / IRD 1010 | TCH 141.03 / IRD 1010 |
| Fan motor | 230 V - 50 Hz - 110 W | 230 V - 50 Hz - 110 W | 230 V - 50 Hz - 110 W | 230 V - 50 Hz - 110 W | 230 V - 50 Hz - 110 W |
| Electrical consumption | 207 W | 207 W | 207 W | 207 W | 207 W |
| Flexible hoses | Rp 3/8" / M14 x 1,5 - 1000 mm | | | | |
| Acoustic level (LpA) | 59 dB(A) | 59 dB(A) | 59 dB(A) | 59 dB(A) | 59 dB(A) |
| Head length | KN | KN | KN | KN | KN |
| Complete burner code | 3832624 | 3832625 | 3832626 | 3832627 | 3832628 |

OTHER AVAILABLE VERSIONS

 Versions for continuous ventilation and post-ventilation

SCOPE OF SUPPLY

The burner is delivered in its package complete with:

- 1 setting template
- 1 burner flange with insulation
- 1 bag containing installation fittings
- 1 bag containing technical documentation (instruction manual, technical data, electrical diagram, exploded view and spare parts list)



DIMENSIONS (mm)

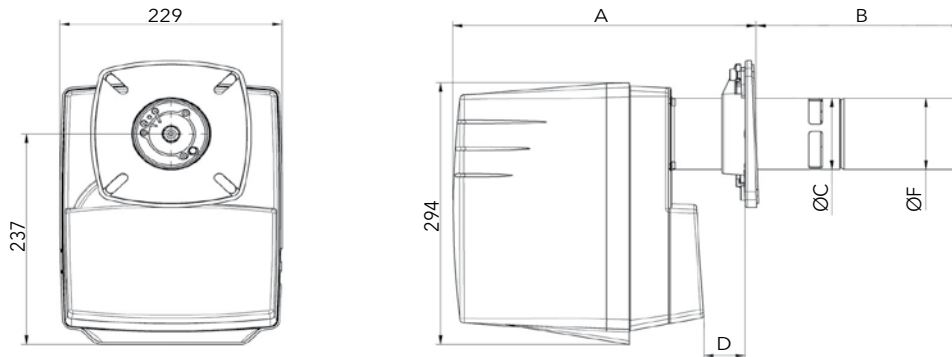

| Model | A | | B | | ØC | D | | ØF |
|--------|-----|-----|-----|-----|----|-----|-----|-----|
| | min | max | min | max | | min | max | |
| VB1.20 | 269 | 284 | 234 | 249 | 80 | 12 | 27 | 80 |
| VB1.24 | 269 | 284 | 234 | 249 | 80 | 12 | 27 | 80 |
| VB1.28 | 269 | 284 | 234 | 249 | 80 | 12 | 27 | 100 |
| VB1.30 | 269 | 284 | 244 | 259 | 80 | 12 | 27 | 100 |
| VB1.35 | 269 | 284 | 294 | 309 | 80 | 12 | 27 | 120 |

Connecting flange

| Øa (mm) | b (mm) | c | d |
|---------|---------|----|-----|
| 85-104 | 150-170 | M8 | 45° |

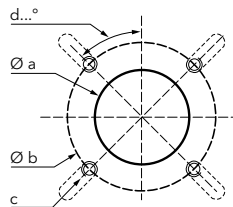

PACKAGING

The burner is delivered in a single package containing all the components

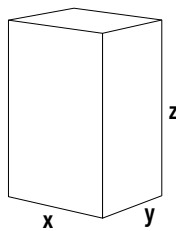

| Burner | Dimensions (mm) | | | Gross weight (kg) |
|--------|-----------------|-----|-----|-------------------|
| | X | Y | Z | |
| VB1.20 | 300 | 260 | 650 | 12 |
| VB1.24 | 300 | 260 | 650 | 12 |
| VB1.28 | 300 | 260 | 650 | 12 |
| VB1.30 | 300 | 260 | 650 | 12 |
| VB1.35 | 300 | 260 | 650 | 12 |

VB2.38 VD / VB2.45 VD / VB2.54 VD / VB2.66 VD

22 ... 66 kW
Two stages (Blue Flame)

- **Fuel:** light oil (viscosity 6 mm²/s at 20°C, H_v = 11,86 kWh/kg)
- **Emissions:** NO_x < 100 mg/kWh (GCV), burners compliant with ErP Directive
- **Protection level:** IP 21

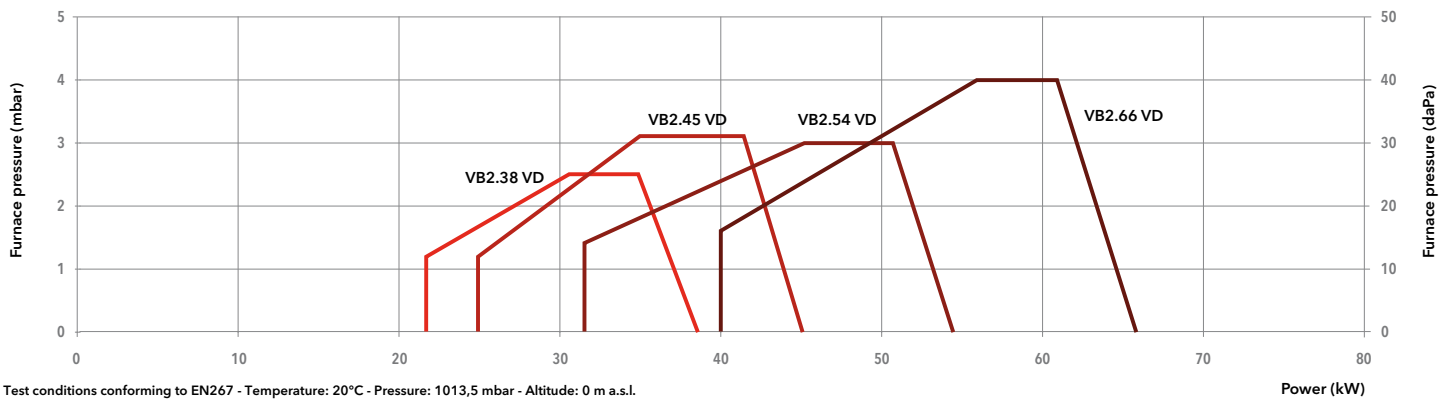
**TECHNICAL DATA**

| Model | VB2.38 VD | VB2.45 VD | VB2.54 VD | VB2.66 VD |
|-------------------------------|-------------------------------|-------------------------------|-------------------------------|-------------------------------|
| Operation range | 22 - 38 kW | 25 - 45 kW | 32 - 54 kW | 40 - 66 kW |
| Fuel flow | 1,8 - 3,2 kg/h | 2,1 - 3,8 kg/h | 2,7 - 4,6 kg/h | 3,4 - 5,6 kg/h |
| Nozzle | 0,55 US gal/h 80°S | 0,55 US gal/h 80°S | 0,65 US gal/h 80°S | 1,00 US gal/h 80°S |
| Control box / flame detection | TCH 24x / IRD 1010 | TCH 24x / IRD 1010 | TCH 24x / IRD 1010 | TCH 24x / IRD 1010 |
| Fan motor | 230 V - 50 Hz - 56 W | 230 V - 50 Hz - 190 W | 230 V - 50 Hz - 190 W | 230 V - 50 Hz - 190 W |
| Electrical consumption | 191 W | 287 W | 325 W | 310 W |
| Flexible hoses | Rp 3/8" / M14 x 1,5 - 1000 mm | Rp 3/8" / M14 x 1,5 - 1000 mm | Rp 3/8" / M14 x 1,5 - 1000 mm | Rp 3/8" / M14 x 1,5 - 1000 mm |
| Acoustic level (LpA) | 59,3 dB(A) | 67,2 dB(A) | 70,2 dB(A) | 68,4 dB(A) |
| Head length | KN | KN | KN | KN |
| Complete burner code | 3835349 | 3835350 | 3835351 | 3835352 |

OTHER AVAILABLE VERSIONS

 Versions for continuous ventilation and post-ventilation

SCOPE OF SUPPLY

The burner is delivered in its package complete with:

- 1 setting template
- 1 burner flange with insulation
- 1 bag containing installation fittings
- 1 bag containing technical documentation (instruction manual, technical data, electrical diagram, exploded view and spare parts list)



DIMENSIONS (mm)

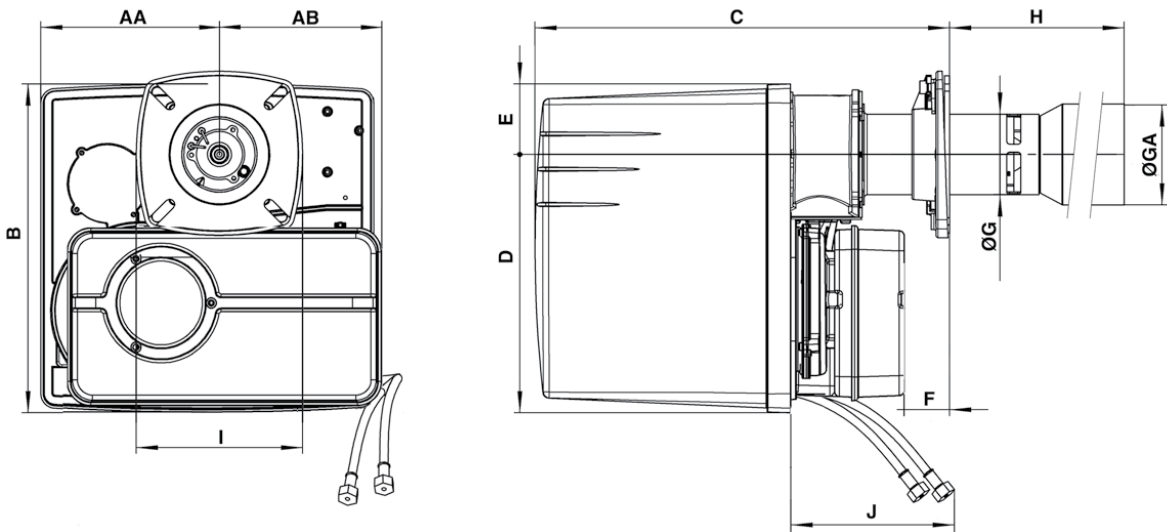

| Model | AA | AB | B | C | D | E | F | ØG | ØGA | H | I | J |
|-----------|-----|-----|-----|-----------|-----|----|---------|-----|-----|-----------|-----|------|
| | | | | KN | | | | | | KN | | |
| VB2.38 VD | 178 | 153 | 325 | 390...450 | 256 | 69 | 15...75 | 80 | 100 | 245...185 | 165 | 1200 |
| VB2.45 VD | 178 | 153 | 325 | 390...450 | 256 | 69 | 15...75 | 80 | 100 | 245...185 | 165 | 1200 |
| VB2.54 VD | 178 | 153 | 325 | 390...450 | 256 | 69 | 15...75 | 80 | 100 | 245...185 | 165 | 1200 |
| VB2.66 VD | 178 | 153 | 325 | 390...450 | 256 | 69 | 15...75 | 100 | 120 | 300...240 | 185 | 1200 |

Connecting flange

| Model | Øa (mm) | b (mm) | c | d |
|-----------------|---------|---------|----|-----|
| VB2.38/45/54 VD | 85-104 | 150-170 | M8 | 45° |
| VB2.66 VD | 110-135 | 150-184 | M8 | 45° |

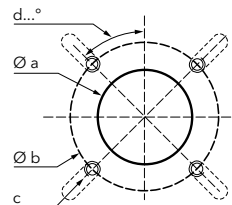

PACKAGING

The burner is delivered in a single package containing all the components

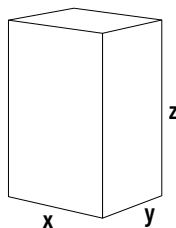

| Burner | Dimensions (mm) | | | Gross weight (kg) |
|-----------|-----------------|-----|-----|-------------------|
| | X | Y | Z | |
| VB2.38 VD | 400 | 400 | 760 | 17 |
| VB2.45 VD | 400 | 400 | 760 | 17 |
| VB2.54 VD | 400 | 400 | 760 | 17 |
| VB2.66 VD | 400 | 400 | 760 | 17 |

VB2.77 VD / VB2.85 VD / VB2.95 VD

45 ... 95 kW
Two stages (Blue Flame)

- **Fuel:** light oil (viscosity 6 mm²/s at 20°C, H_v = 11,86 kWh/kg)
- **Emissions:** NO_x < 100 mg/kWh (GCV), burners compliant with ErP Directive
- **Protection level:** IP 21

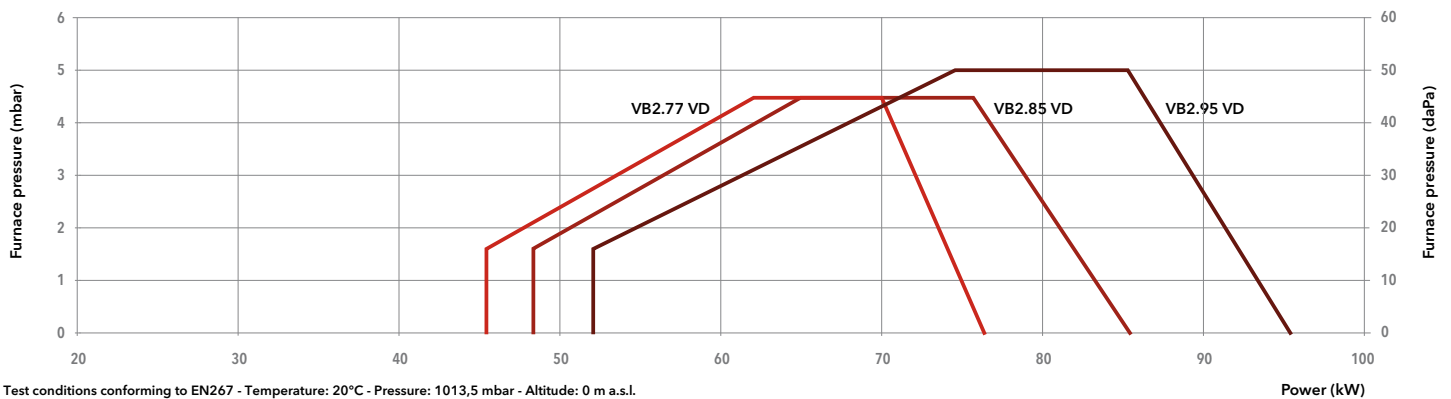
**TECHNICAL DATA**

| Model | VB2.77 VD | VB2.85 VD | VB2.95 VD |
|-------------------------------|-------------------------------|-------------------------------|-------------------------------|
| Operation range | 45 - 77 kW | 48 - 85 kW | 52 - 95 kW |
| Fuel flow | 3,8 - 6,5 kg/h | 4,0 - 7,2 kg/h | 4,4 - 8,0 kg/h |
| Nozzle | 1,10 US gal/h 80°S | 1,25 US gal/h 80°S | 1,25 US gal/h 80°S |
| Control box / flame detection | TCH 24x / IRD 1010 | TCH 24x / IRD 1010 | TCH 24x / IRD 1010 |
| Fan motor | 230 V - 50 Hz - 190 W | 230 V - 50 Hz - 190 W | 230 V - 50 Hz - 190 W |
| Electrical consumption | 276 W | 285 W | 262 W |
| Flexible hoses | Rp 3/8" / DN6 x 1,5 - 1500 mm | Rp 3/8" / DN6 x 1,5 - 1500 mm | Rp 3/8" / DN6 x 1,5 - 1500 mm |
| Acoustic level (LpA) | 68,5 dB(A) | 66,5 dB(A) | 67,6 dB(A) |
| Head length | KN | KN | KN |
| Complete burner code | 3835353 | 3835354 | 3835355 |

OTHER AVAILABLE VERSIONS

 Versions for continuous ventilation and post-ventilation

SCOPE OF SUPPLY

The burner is delivered in its package complete with:

- 1 setting template
- 1 burner flange with insulation
- 1 bag containing installation fittings
- 1 bag containing technical documentation (instruction manual, technical data, electrical diagram, exploded view and spare parts list)



DIMENSIONS (mm)

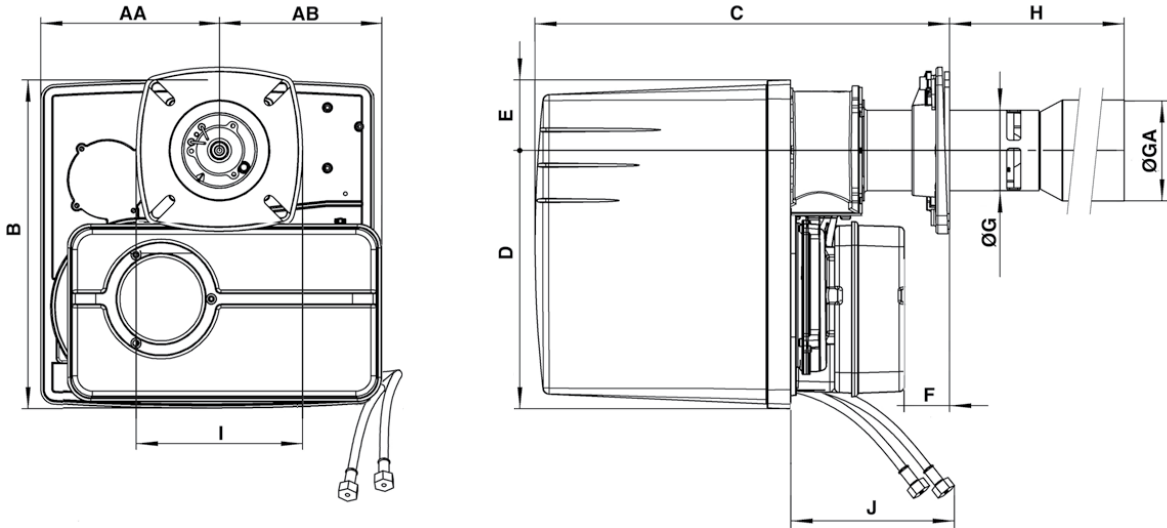

| Model | AA | AB | B | C | D | E | F | ØG | ØGA | H | I | J |
|-----------|-----|-----|-----|-----------|-----|----|---------|-----|-----|-----------|-----|------|
| | | | | KN | | | | | | KN | | |
| VB2.77 VD | 178 | 153 | 325 | 390...450 | 256 | 69 | 15...75 | 100 | 120 | 300...240 | 185 | 1200 |
| VB2.85 VD | 178 | 153 | 325 | 390...450 | 256 | 69 | 15...75 | 100 | 120 | 300...240 | 185 | 1200 |
| VB2.95 VD | 178 | 153 | 325 | 390...450 | 256 | 69 | 15...75 | 100 | 120 | 300...240 | 185 | 1200 |

Connecting flange

| Øa (mm) | b (mm) | c | d |
|---------|---------|----|-----|
| 110-135 | 150-184 | M8 | 45° |

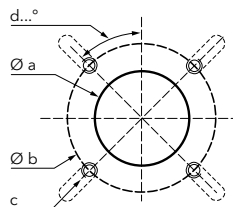

PACKAGING

The burner is delivered in a single package containing all the components

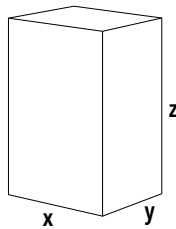

| Burner | Dimensions (mm) | | | Gross weight (kg) |
|-----------|-----------------|-----|-----|-------------------|
| | X | Y | Z | |
| VB2.77 VD | 400 | 400 | 760 | 17 |
| VB2.85 VD | 400 | 400 | 760 | 17 |
| VB2.95 VD | 400 | 400 | 760 | 17 |

VB30.120 D / VB30.190 D / VB30.230 D50 ... 240 kW
Two stages

- Fuel: light oil, Hi = 11,86 kWh/kg;
- Emissions: NO_x < 100 mg/kWh (GCV), burners compliant with ErP Directive
- Protection level: IP 21

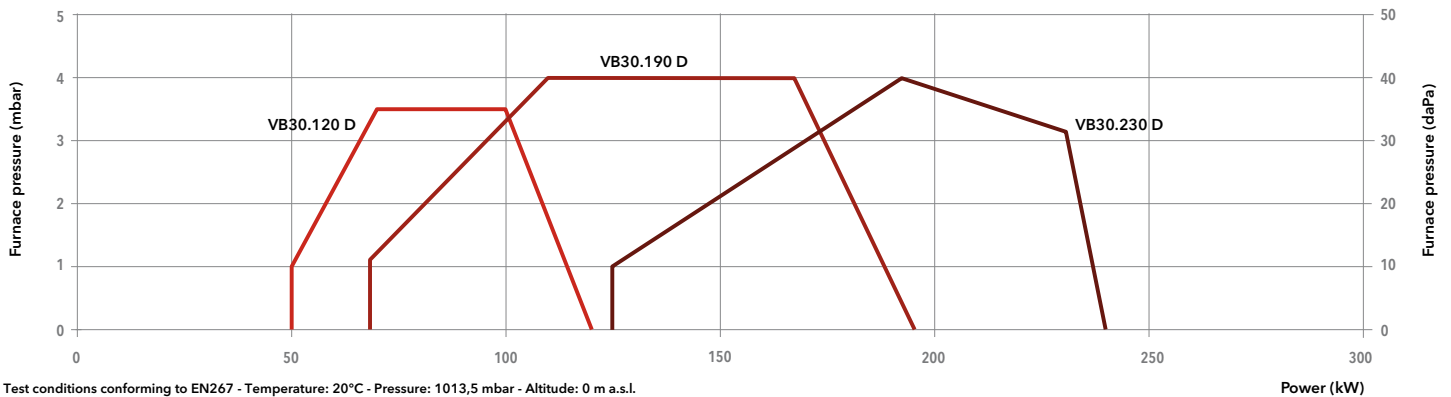
TECHNICAL DATA

| Model | VB30.120 D | VB30.190 D | VB30.230 D |
|-------------------------------|-----------------------|-----------------------|-----------------------|
| Operation range | 50 - 120 kW | 68 - 195 kW | 125 - 240 kW |
| Fuel flow | 4,2 - 10,1 kg/h | 5,7 - 16,4 kg/h | 10,5 - 20,2 kg/h |
| Nozzles | 1,65 US gal/h 80°S | 2,75 US gal/h 80°A | 3,25 US gal/h 80°A |
| Control box / flame detection | DK0992 / KLC2002 | DK0992 / KLC2002 | DK0992 / KLC2002 |
| Fan motor | 230 V - 50 Hz - 260 W | 230 V - 50 Hz - 380 W | 230 V - 50 Hz - 380 W |
| Electrical consumption | 360 W | 550 W | 550 W |
| Acoustic level (LpA) | 68 dB(A) | 69 dB(A) | 69 dB(A) |
| Complete burner code | 3722921 | 3722922 | 3722923 |

OTHER AVAILABLE VERSIONS

 Versions for continuous ventilation and post-ventilation

SCOPE OF SUPPLY

The burner is delivered in its package complete with:

- 1 burner head with flange seal and securing screws
- 1 bag containing installation fittings
- 1 bag containing technical documentation (instruction manual, technical data, electrical diagram, exploded view and spare parts list)



DIMENSIONS (mm)

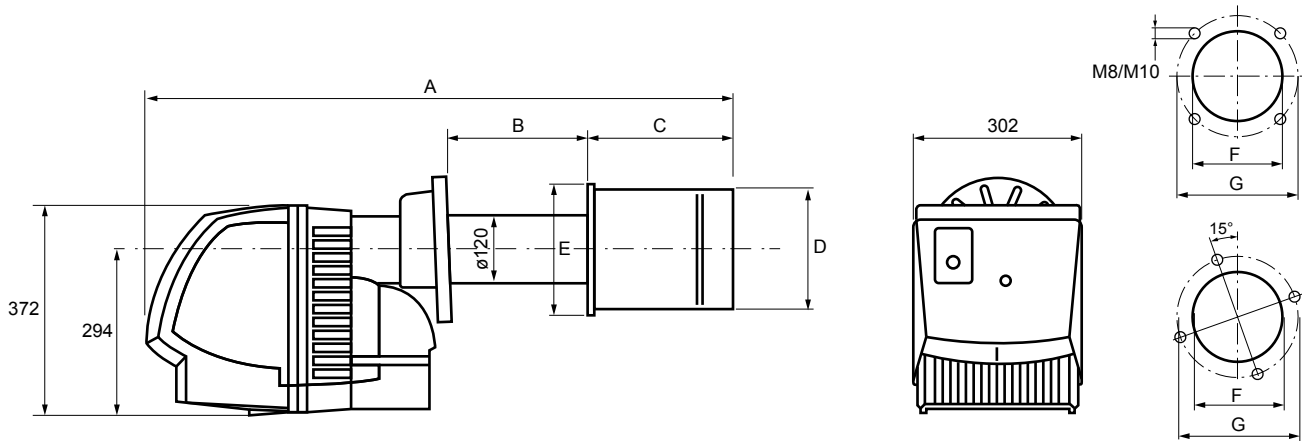

| Model | A | B | C | ØD | ØE | ØF | ØG |
|------------|-----|---------|-----|-----|-----|---------|-----------|
| VB30.120 D | 824 | max 145 | 180 | 150 | 175 | min 130 | 170 - 220 |
| VB30.190 D | 856 | max 145 | 210 | 160 | 190 | min 130 | 170 - 220 |
| VB30.230 D | 866 | max 145 | 220 | 160 | 212 | min 130 | 170 - 220 |

PACKAGING

The burner is delivered in a single package containing all the components

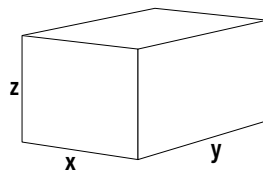

| Burner | Dimensions (mm) | | | Gross weight (kg) |
|----------|-----------------|-----|-----|-------------------|
| | X | Y | Z | |
| VB30.120 | 430 | 370 | 800 | 29 |
| VB30.190 | 430 | 370 | 800 | 29 |
| VB30.230 | 430 | 370 | 800 | 29 |

VB35.320 D / VB35.370 D120 ... 375 kW
Two stages

- Fuel: light oil, Hi = 11,86 kWh/kg;
- Emissions: NO_x < 100 mg/kWh (GCV), burners compliant with ErP Directive
- Protection level: IP 21

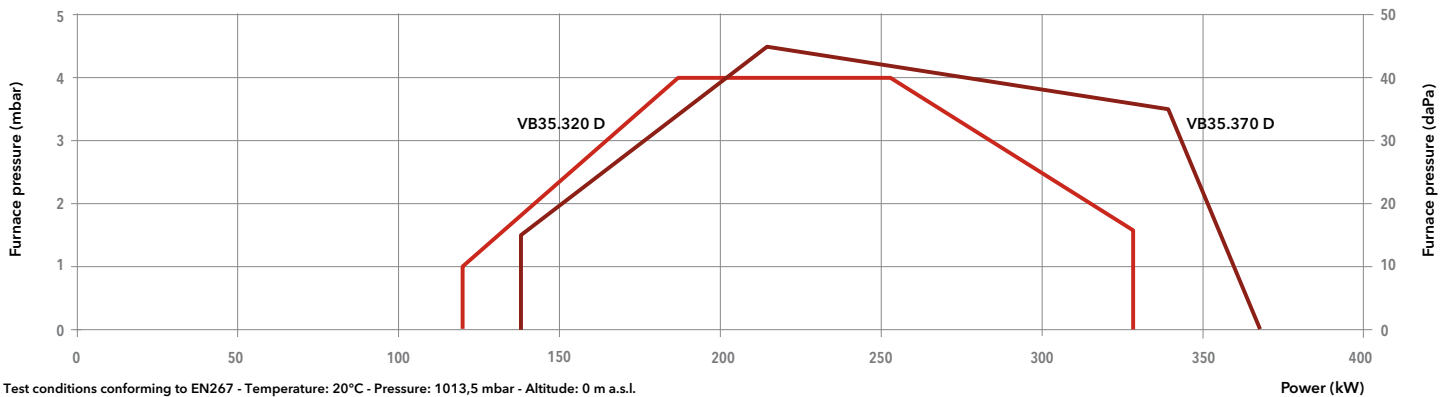
TECHNICAL DATA

| Model | VB35.320 D | VB35.370 D |
|-------------------------------|-----------------------|-----------------------|
| Operation range | 120 - 330 kW | 140 - 375 kW |
| Fuel flow | 10,1 - 27,8 kg/h | 11,8 - 31,6 kg/h |
| Nozzles | 3,50 US gal/h 80°A | 4,50 US gal/h 80°A |
| Control box / flame detection | DKO992 / KLC2002 | DKO992 / KLC2002 |
| Fan motor | 230 V - 50 Hz - 650 W | 230 V - 50 Hz - 650 W |
| Electrical consumption | 830 W | 830 W |
| Acoustic level (LpA) | 72 dB(A) | 72 dB(A) |
| Complete burner code | 3722924 | 3722925 |

OTHER AVAILABLE VERSIONS

 Versions for continuous ventilation and post-ventilation

SCOPE OF SUPPLY

The burner is delivered in its package complete with:

- 1 burner head with flange seal and securing screws
- 1 bag containing installation fittings
- 1 bag containing technical documentation (instruction manual, technical data, electrical diagram, exploded view and spare parts list)



DIMENSIONS (mm)

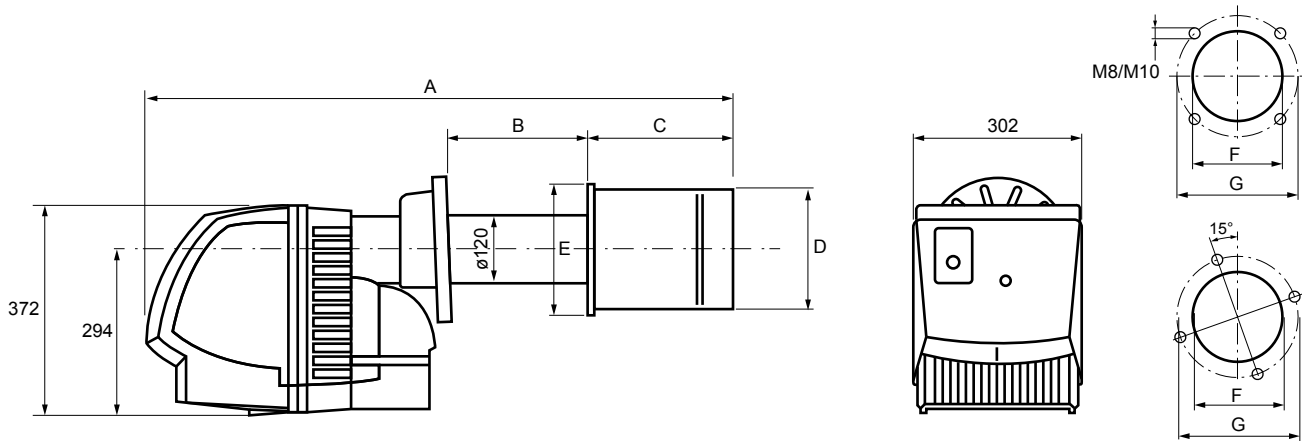

| Model | A | B | C | ØD | ØE | ØF | ØG |
|------------|------|---------|-----|-----|-----|---------|-----------|
| VB35.320 D | 1010 | max 260 | 220 | 180 | 212 | min 130 | 170 - 220 |
| VB35.370 D | 1048 | max 260 | 260 | 210 | 230 | min 130 | 170 - 220 |

PACKAGING

The burner is delivered in a single package containing all the components

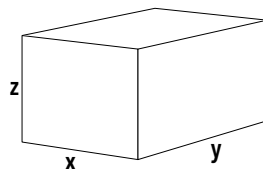

| Burner | Dimensions (mm) | | | Gross weight (kg) |
|----------|-----------------|-----|-----|-------------------|
| | X | Y | Z | |
| VB35.320 | 490 | 400 | 890 | 37 |
| VB35.370 | 490 | 400 | 890 | 37 |

VB40.420 D / VB40.460 D / VB40.590 D / VB45.810 D135 ... 825 kW
Two stages

- **Fuel:** light oil, Hi = 11,86 kWh/kg;
- **Emissions:** NOx < 100 mg/kWh (GCV), Low NOx class 3 burners according to EN267
- **Protection level:** IP 21

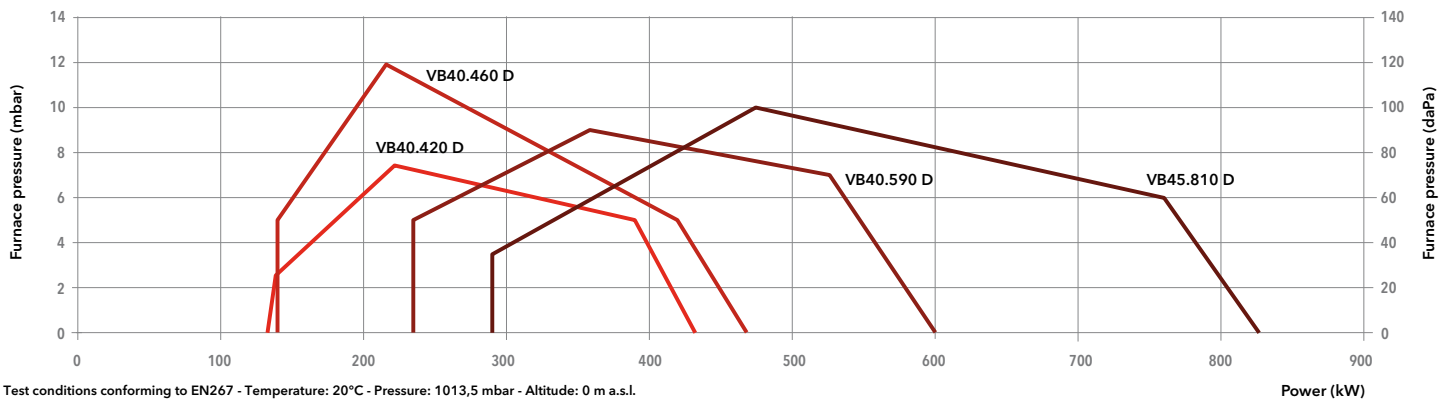
TECHNICAL DATA

| Model | VB40.420 D | VB40.460 D | VB40.590 D | VB45.810 D |
|-------------------------------|-----------------------|-----------------------|-----------------------|-----------------------|
| Operation range | 135 - 430 kW | 140 - 470 kW | 230 - 600 kW | 290 - 825 kW |
| Fuel flow | 11,4 - 36,2 kg/h | 11,8 - 39,6 kg/h | 19,4 - 50,6 kg/h | 24,4 - 69,5 kg/h |
| Nozzles | 5,50 US gal/h 80°A | 7,00 US gal/h 80°A | 7,00 US gal/h 80°A | 9,50 US gal/h 80°A |
| Control box / flame detection | DKO992 / KLC2002 | DKO992 / KLC2002 | DKO992 / KLC2002 | DKO992 / KLC2002 |
| Fan motor | 230 V - 50 Hz - 260 W | 230 V - 50 Hz - 380 W | 230 V - 50 Hz - 650 W | 230 V - 50 Hz - 650 W |
| Electrical consumption | 1280 W | 1450 W | 2050 W | 2480 W |
| Acoustic level (LpA) | 69 dB(A) | 69 dB(A) | 70 dB(A) | 74 dB(A) |
| Complete burner code | 3722926 | 3722927 | 3722928 | 3722929 |

OTHER AVAILABLE VERSIONS

 Versions for continuous ventilation and post-ventilation

SCOPE OF SUPPLY

The burner is delivered in its package complete with:

- 1 burner head with flange seal and securing screws
- 1 bag containing installation fittings
- 1 bag containing technical documentation (instruction manual, technical data, electrical diagram, exploded view and spare parts list)



DIMENSIONS (mm)

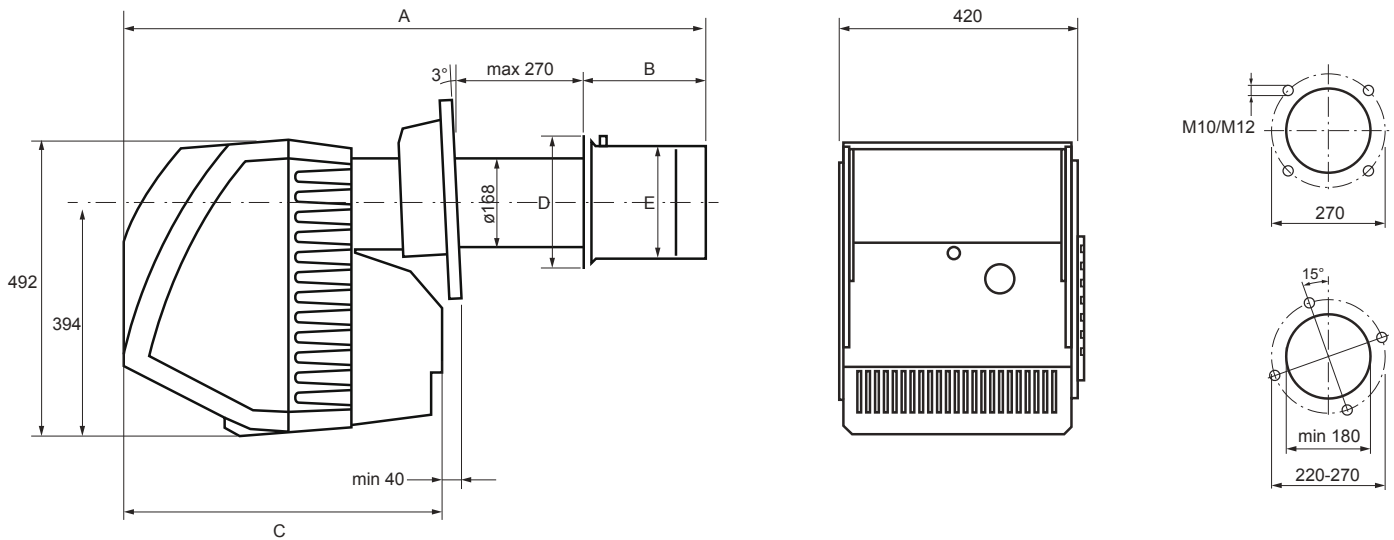

| Model | A | B | C | ØD | ØE |
|------------|------|-----|-----|-----|-----|
| VB40.420 D | 1176 | 255 | 611 | 210 | 300 |
| VB40.460 D | 1176 | 255 | 611 | 210 | 300 |
| VB40.590 D | 1206 | 285 | 611 | 250 | 300 |
| VB45.810 D | 1291 | 330 | 651 | 280 | 330 |

PACKAGING

The burner is delivered in a single package containing all the components

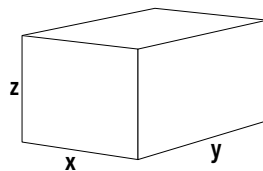

| Burner | Dimensions (mm) | | | Gross weight (kg) |
|----------|-----------------|-----|------|-------------------|
| | X | Y | Z | |
| VB40.420 | 540 | 540 | 1180 | 60 |
| VB40.460 | 540 | 540 | 1180 | 60 |
| VB40.590 | 540 | 540 | 1180 | 60 |
| VB45.810 | 540 | 540 | 1180 | 65 |

EK EVO 4 L-EOT / EK EVO 5 L-EOT

260 ... 1450 kW

Two stage progressive/modulating electronic



- **Fuel:** light oil, Hi = 11,86 kWh/kg;
- **Emissions:** Ultra low NO_x burners with NO_x values between 62 and 76 mg/kWh (NCV)
- **Protection level:** IP 40 (IP 54 as option)

TECHNICAL DATA

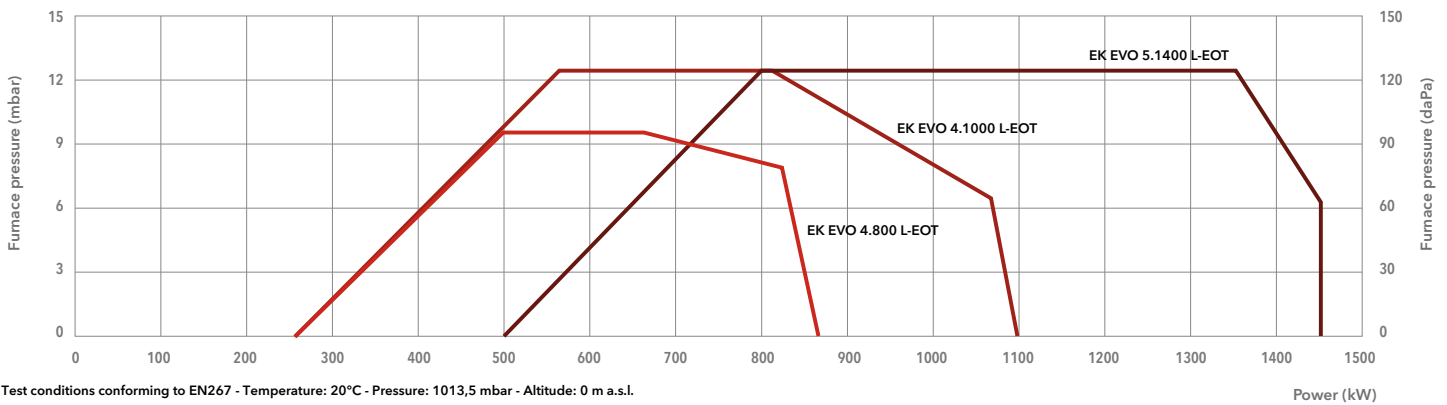

Test conditions conforming to EN267 - Temperature: 20°C - Pressure: 1013,5 mbar - Altitude: 0 m a.s.l.

| | EK EVO 4.800 L-EOT | EK EVO 4.1000 L-EOT | EK EVO 5.1400 L-EOT |
|-------------------------------------|-------------------------------|-------------------------------|------------------------------|
| Operating range | 260 - 870 kW | 260 - 1100 kW | 500 - 1450 kW |
| Fuel connection | DN20 x 1500 mm / R 1/2" | DN20 x 1500 mm / R 3/4" | DN20 x 1500 mm / R 3/4" |
| Control box / flame detector | BT300 / KLC20* | BT300 / KLC20* | BT300 / KLC20* |
| Auxiliary voltage | 1NPE AC 230 V - 50 Hz TN-S | 1NPE AC 230 V - 50 Hz TN-S | 1NPE AC 230 V - 50 Hz TN-S |
| Power supply | 3PE AC 400 V - 50 Hz | 3PE AC 400 V - 50 Hz | 3PE AC 400 V - 50 Hz |
| Electric motor | 2,2 kW | 2,2 kW | 4 kW |
| Pump | SUNTEC AJ6 - 230 l/h - 30 bar | SUNTEC AJ6 - 230 l/h - 30 bar | HP UHE-A2 - 400 l/h - 30 bar |
| Acoustic level | <80,5 dB(A) | <80,5 dB(A) | <83,3 dB(A) |
| Complete burner code | 3758954 | 3758953 | 3758955 |

*: FFS08 optional for model in PED configuration

OTHER AVAILABLE VERSIONS

PED PED version for continuous operation

| | EK EVO 4.800 L-EOT / PED | EK EVO 4.1000 L-EOT / PED | EK EVO 5.1400 L-EOT / PED |
|-----------------------------------|--------------------------|---------------------------|---------------------------|
| Burner codes (body + head) | 3759111 | 3759112 | 3759113 |

SCOPE OF SUPPLY

The burner is delivered in its package complete with:

- 1 burner head with flange seal and securing screws
- 1 bag containing installation fittings
- 1 bag containing technical documentation (instruction manual, technical data, electrical diagram, exploded view and spare parts list)



DIMENSIONS (mm)

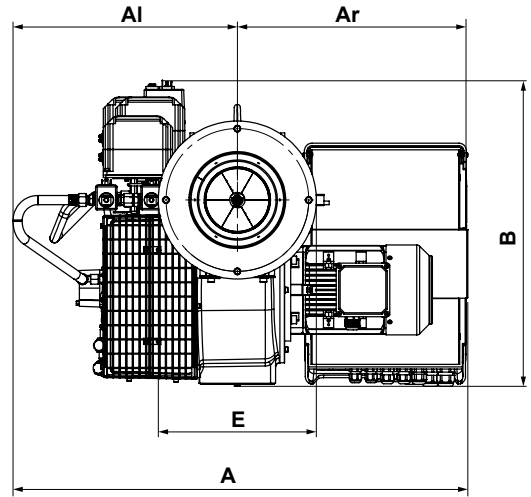
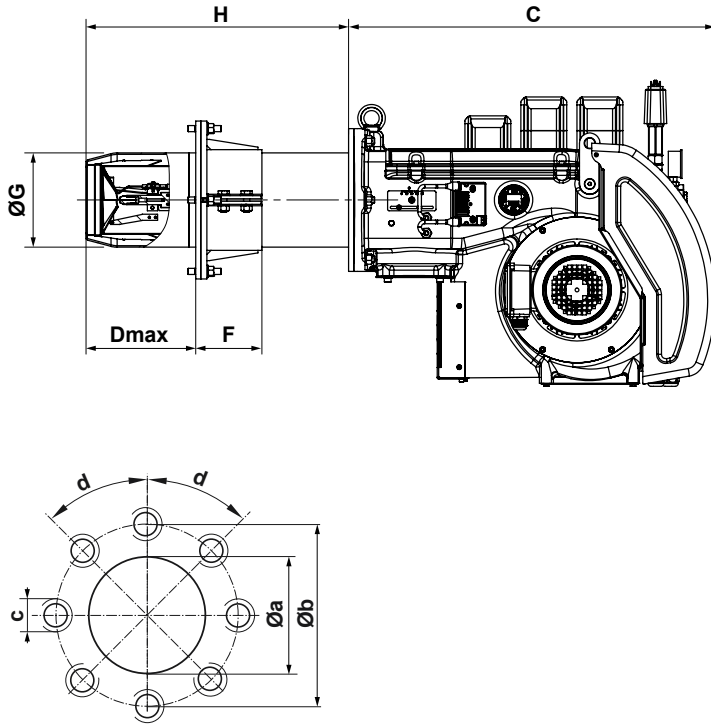

| Model | A | A _l | A _r | B | C | D max | E | F | ØG | H | Øa | b | c | d |
|---------------------|-----|----------------|----------------|-----|-----|-------|-----|-----|-----|-----|-----|-----|-----|-----|
| EK EVO 4.800 L-EOT | 850 | 400 | 450 | 610 | 715 | 370 | 310 | 145 | 185 | 515 | 205 | 280 | M12 | 45° |
| EK EVO 4.1000 L-EOT | 850 | 400 | 450 | 610 | 715 | 410 | 370 | 145 | 220 | 555 | 250 | 340 | M12 | 45° |
| EK EVO 5.1400 L-EOT | 855 | 400 | 455 | 630 | 810 | 510 | 370 | 145 | 220 | 655 | 250 | 340 | M12 | 45° |

PACKAGING

The burner is delivered in a single package containing all the components

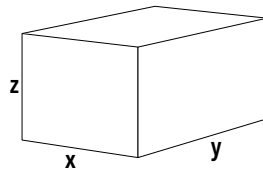

| Burner | Dimensions (mm) | | | Gross weight (kg) |
|---------------|-----------------|------|-----|-------------------|
| | X | Y | Z | |
| EK EVO 4.800 | 1140 | 1370 | 950 | 170,5 |
| EK EVO 4.1000 | 1140 | 1370 | 950 | 170,5 |
| EK EVO 5.1400 | 1000 | 1500 | 940 | 199,5 |

VL1.40 P / VL1.55 P / VL1.42 / VL1.55 / VL1.10518 ... 105 kW
One stage

- **Fuel:** light oil (viscosity 6 mm²/s at 20°C, H_v = 11,86 kWh/kg)
- **Emissions:** NO_x < 120 mg/kWh (GCV), burners compliant with ErP Directive
- **Protection level:** IP 21

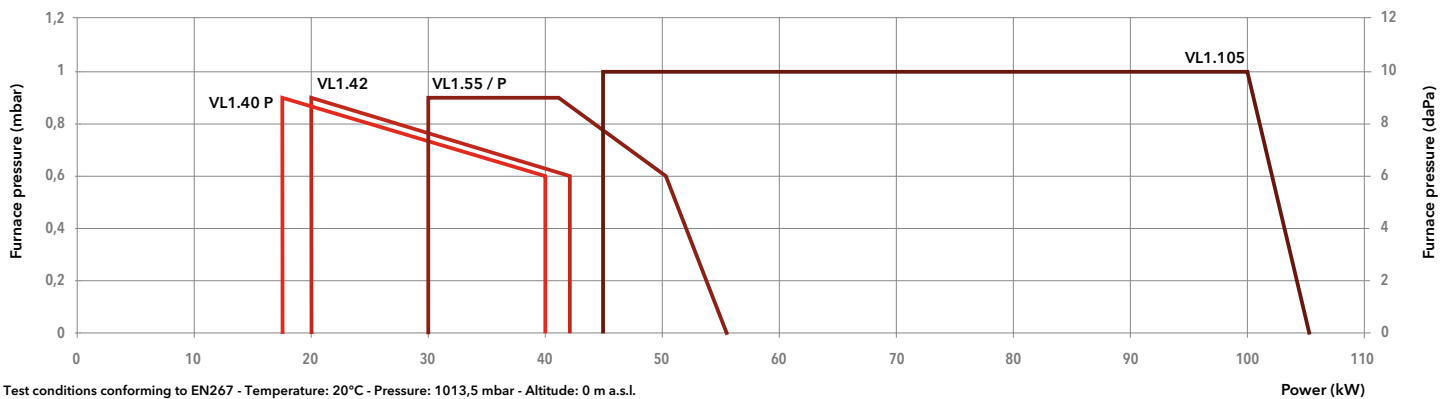
TECHNICAL DATA

| Model | VL1.40 P * | VL1.55 P * | VL1.42 | VL1.55 | VL1.105 | |
|-------------------------------|-------------------------------|--------------------|--------------------|--------------------|--------------------|---------|
| Operation range | 18 - 40 kW | 30 - 55 kW | 20 - 42 kW | 30 - 55 kW | 45 - 105 kW | |
| Fuel flow | 1,5 - 3,3 kg/h | 2,5 - 4,6 kg/h | 1,7 - 3,5 kg/h | 2,5 - 4,6 kg/h | 3,8 - 8,8 kg/h | |
| Nozzle | 0,50 US gal/h 60°S | 1,00 US gal/h 45°S | 0,60 US gal/h 60°S | 1,00 US gal/h 45°S | 1,25 US gal/h 45°S | |
| Control box / flame detection | TCH 141.03 / QRB1 | | | | | |
| Fan motor | 230 V - 50 Hz - 110 W | | | | | |
| Electrical consumption | 244 W | 244 W | 195 W | 195 W | 240 W | |
| Flexible hoses | Rp 3/8" / M14 x 1,5 - 1000 mm | | | | | |
| Acoustic level (LpA) | 55 dB(A) | 55 dB(A) | 55 dB(A) | 55 dB(A) | 60,5 dB(A) | |
| Head length | KN | KN | KN | KN | KN | KL |
| Complete burner code | 3832615 | 3833026 | 3832616 | 3832617 | 3836898 | 3836899 |

*: pre-heater

OTHER AVAILABLE VERSIONS

 Versions for continuous ventilation and post-ventilation

SCOPE OF SUPPLY

The burner is delivered in its package complete with:

- 1 burner flange with insulation
- 1 bag containing installation fittings
- 1 bag containing technical documentation (instruction manual, technical data, electrical diagram, exploded view and spare parts list)



DIMENSIONS (mm)

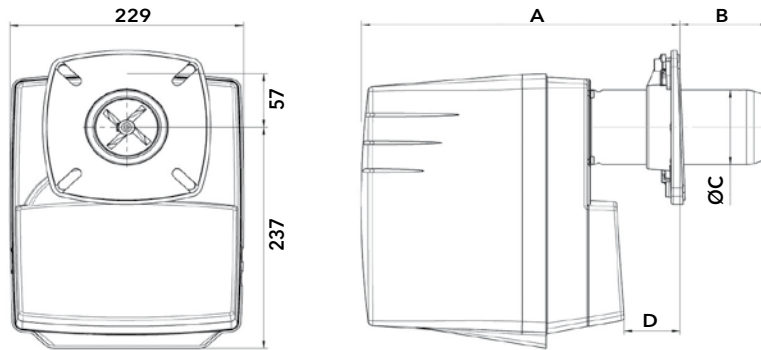

| Model | A | | B | | | ØC | D | |
|----------|-----|-----|-----|--------|--------|----|-----|-----|
| | min | max | min | KN max | KL max | | min | max |
| VL1.40 P | 270 | 310 | 70 | 120 | - | 80 | 21 | 71 |
| VL1.42 | 270 | 310 | 70 | 120 | - | 80 | 21 | 71 |
| VL1.55 | 270 | 310 | 70 | 120 | - | 80 | 21 | 71 |
| VL1.55 P | 270 | 310 | 70 | 120 | - | 80 | 21 | 71 |
| VL1.105 | 297 | 357 | 70 | 138 | 200 | 90 | 15 | 83 |

Connecting flange

| Model | Øa (mm) | b (mm) | c | d |
|-----------|---------|---------|----|-----|
| VL1.40/55 | 85-104 | 150-170 | M8 | 45° |
| VL1.105 | 95-104 | 150-170 | M8 | 45° |

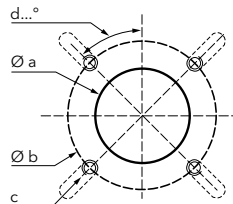

PACKAGING

The burner is delivered in a single package containing all the components

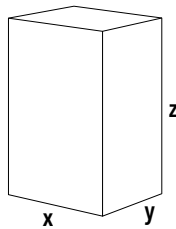

| Burner | Dimensions (mm) | | | Gross weight (kg) |
|----------|-----------------|-----|-----|-------------------|
| | X | Y | Z | |
| VL1.40 P | 300 | 260 | 650 | 11 |
| VL1.42 | 300 | 260 | 650 | 11 |
| VL1.55 | 300 | 260 | 650 | 11 |
| VL1.55 P | 300 | 260 | 650 | 11 |
| VL1.105 | 300 | 260 | 650 | 12 |

VL2.140 / VL2.20080 ... 200 kW
One stage

- **Fuel:** light oil (viscosity 6 mm²/s at 20°C, H_v = 11,86 kWh/kg)
- **Emissions:** NO_x < 120 mg/kWh (GCV), burners compliant with ErP Directive
- **Protection level:** IP 21

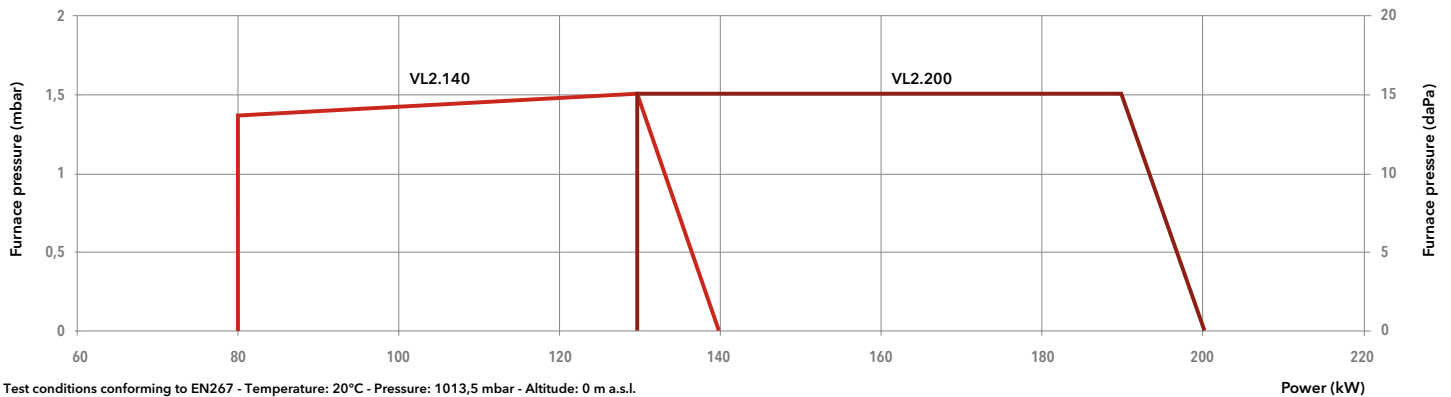
**TECHNICAL DATA**

| Model | VL2.140 | | VL2.200 | |
|-------------------------------|-------------------------------|---------|-------------------------------|---------|
| Operation range | 80 - 140 kW | | 130 - 200 kW | |
| Fuel flow | 6,7 - 11,8 kg/h | | 11 - 16,9 kg/h | |
| Nozzle | 2,25 US gal/h 45°S | | 3,50 US gal/h 45°S | |
| Control box / flame detection | TCH1... / QRB1 | | TCH1... / QRB1 | |
| Fan motor | 230 V - 50 Hz - 160 W | | 230 V - 50 Hz - 130 W | |
| Electrical consumption | 274 W | | 290 W | |
| Flexible hoses | Rp 3/8" / DN6 x 1,5 - 1500 mm | | Rp 3/8" / DN6 x 1,5 - 1500 mm | |
| Acoustic level (LpA) | 62 dB(A) | | 65 dB(A) | |
| Head length | KN | KL | KN | KL |
| Complete burner code | 3833536 | 3833537 | 3833540 | 3833541 |

OTHER AVAILABLE VERSIONS

 Versions for continuous ventilation and post-ventilation

SCOPE OF SUPPLY

The burner is delivered in its package complete with:

- 2 oil hoses
- 1 burner flange with insulation
- 1 bag containing installation fittings
- 1 bag containing technical documentation (instruction manual, technical data, electrical diagram, exploded view and spare parts list)



DIMENSIONS (mm)

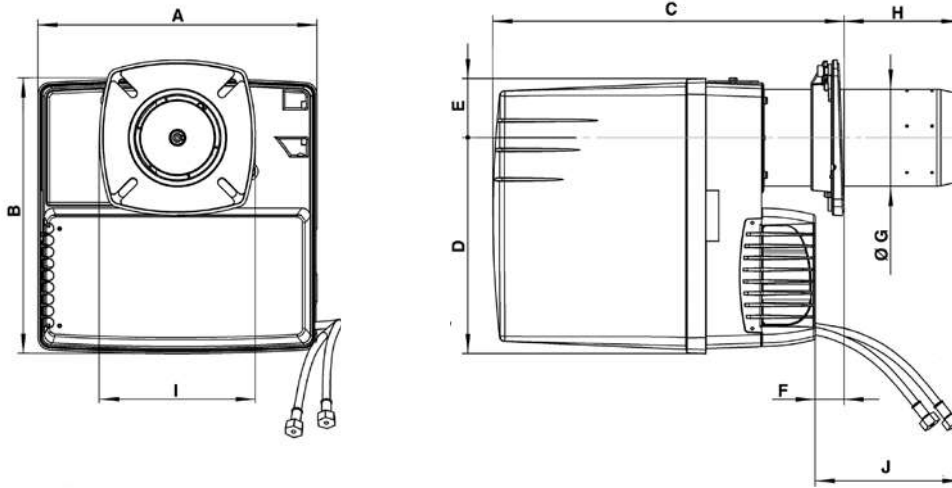

| Model | A | B | C | | D | E | F min | ØG | H | | I | J |
|---------|-----|-----|-----------|-----------|-----|----|----------|-----|----------|----------|-----|------|
| | | | KN | KL | | | | | KN | KL | | |
| VL2.140 | 331 | 325 | 398...518 | 398...638 | 256 | 69 | 15 | 100 | 30...150 | 30...270 | 185 | 1200 |
| VL2.200 | 331 | 325 | 398...518 | 398...638 | 256 | 69 | 15 | 115 | 30...150 | 30...270 | 185 | 1200 |

Connecting flange

| Øa (mm) | b (mm) | c | d |
|---------|---------|----|-----|
| 120-135 | 150-184 | M8 | 45° |

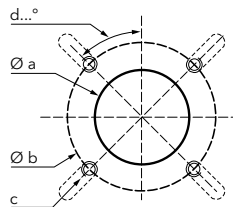

PACKAGING

The burner is delivered in a single package containing all the components

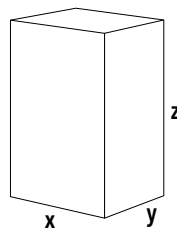

| Burner | Dimensions (mm) | | | Gross weight (kg) |
|---------|-----------------|-----|-----|-------------------|
| | X | Y | Z | |
| VL2.140 | 400 | 400 | 760 | 18 |
| VL2.200 | 400 | 400 | 760 | 18 |

VL2.120 D / VL2.160 D / VL2.210 D

60 ... 210 kW
Two stages



- **Fuel:** light oil (viscosity 6 mm²/s at 20°C, H_v = 11,86 kWh/kg)
- **Emissions:** NO_x < 120 mg/kWh (GCV), burners compliant with ErP Directive
- **Protection level:** IP 21

TECHNICAL DATA

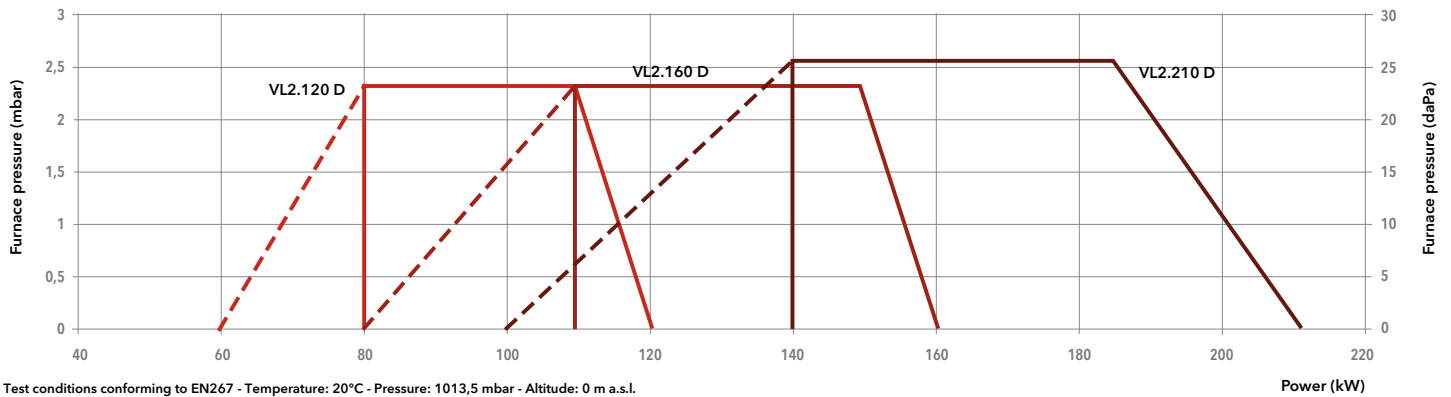

| Model | VL2.120 D | | VL2.160 D | | VL2.210 D | |
|-------------------------------|-------------------------------|---------|-------------------------------|---------|-------------------------------|---------|
| Operation range | (60) 80 - 120 kW | | (80) 110 - 160 kW | | (100) 140 - 210 kW | |
| Fuel flow | 4,6 - 10,0 kg/h | | 6,1 - 13,5 kg/h | | 8,4 - 17,7 kg/h | |
| Nozzles | 1,50 US gal/h 45°S | | 2,25 US gal/h 45°S | | 2,75 US gal/h 45°S | |
| Control box / flame detection | TCH 2... / QRB1 | | TCH 2... / QRB1 | | TCH 2... / QRB1 | |
| Fan motor | 230 V - 50 Hz - 160 W | | 230 V - 50 Hz - 160 W | | 230 V - 50 Hz - 130 W | |
| Electrical consumption | 216 W | | 290 W | | 345 W | |
| Flexible hoses | Rp 3/8" / M14 x 1,5 - 1500 mm | | Rp 3/8" / M14 x 1,5 - 1500 mm | | Rp 3/8" / M14 x 1,5 - 1500 mm | |
| Acoustic level (LpA) | 62 dB(A) | | 64 dB(A) | | 65 dB(A) | |
| Head length | KN | KL | KN | KL | KN | KL |
| Complete burner code | 3833344 | 3833345 | 3833346 | 3833347 | 3833348 | 3833349 |

OTHER AVAILABLE VERSIONS

 Versions for continuous ventilation and post-ventilation

SCOPE OF SUPPLY

The burner is delivered in its package complete with:

- 1 setting template
- 1 burner flange with insulation
- 1 bag containing installation fittings
- 1 bag containing technical documentation (instruction manual, technical data, electrical diagram, exploded view and spare parts list)



DIMENSIONS (mm)

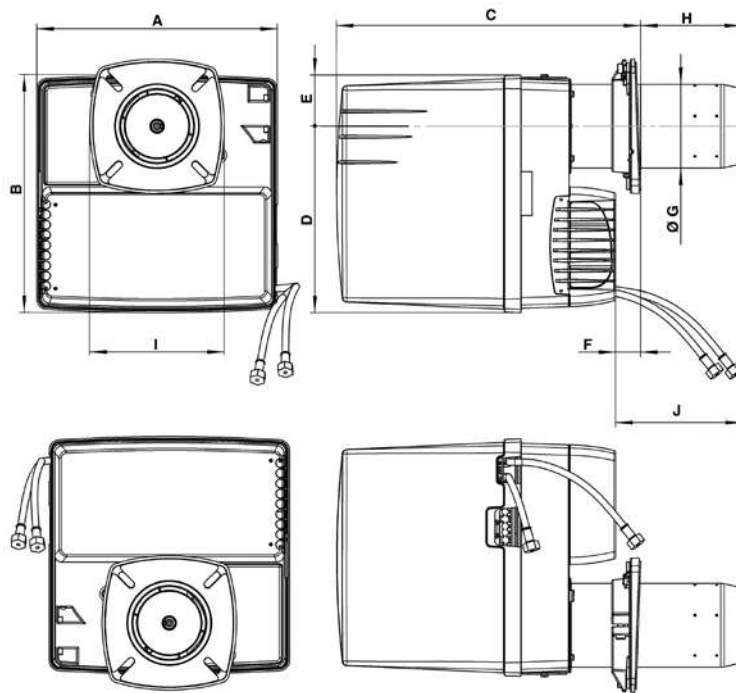

| A | B | C | | D | E | F min | ØG | H | | I | J |
|-----|-----|-----------|-----------|-----|----|----------|-----|----------|----------|---------|------|
| | | KN | KL | | | | | KN | KL | | |
| 331 | 326 | 398...518 | 398...638 | 256 | 69 | 15 | 115 | 30...150 | 30...270 | 185x185 | 1200 |

Connecting flange

| Øa (mm) | b (mm) | c | d |
|---------|---------|----|-----|
| 120-135 | 150-184 | M8 | 45° |

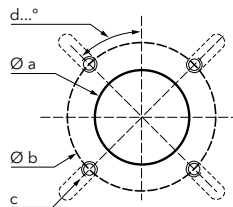

PACKAGING

The burner is delivered in a single package containing all the components

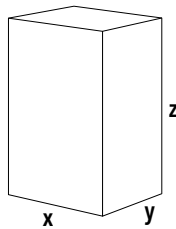

| Burner | Dimensions (mm) | | | Gross weight (kg) |
|-----------|-----------------|-----|-----|-------------------|
| | X | Y | Z | |
| VL2.120 D | 400 | 400 | 770 | 18 |
| VL2.160 D | 400 | 400 | 770 | 18 |
| VL2.210 D | 400 | 400 | 770 | 19 |

VL3.290 D / VL3.360 D / VL4.440 D

130 ... 440 kW
Two stages



- **Fuel:** light oil (viscosity 6 mm²/s at 20°C, H_v = 11,86 kWh/kg)
- **Emissions:** NO_x < 120 mg/kWh (GCV), burners compliant with ErP Directive
- **Protection level:** IP 21

TECHNICAL DATA

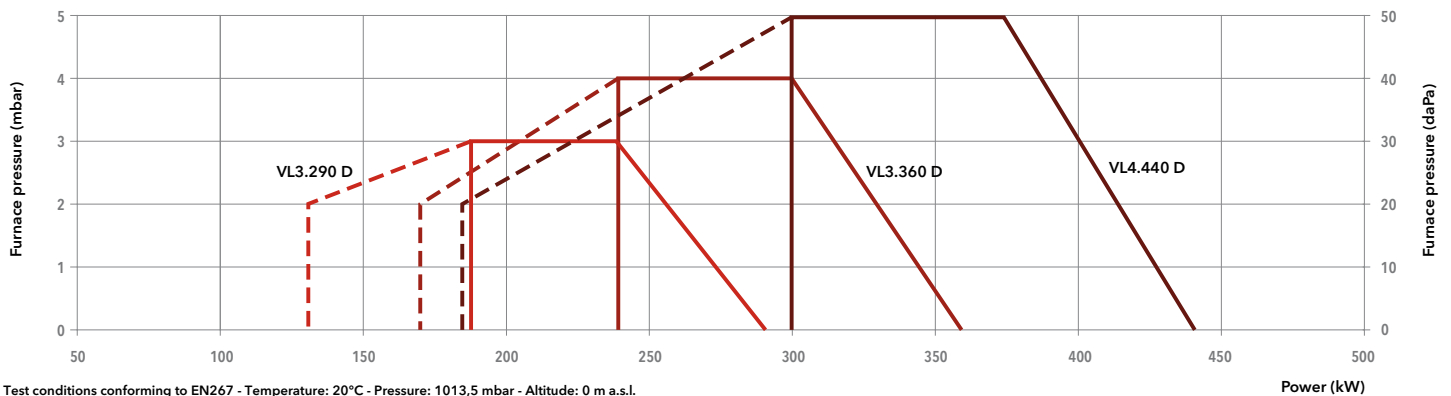

| Model | VL3.290 D | | VL3.360 D | | VL4.440 D | |
|-------------------------------|-------------------------|---------|-------------------------|---------|--|---------|
| Operation range | (130) 185 - 290 kW | | (170) 240 - 360 kW | | (180) 300 - 440 kW | |
| Fuel flow | 15,6 - 24,4 kg/h | | 20,2 - 30,3 kg/h | | 25,3 - 37,0 kg/h | |
| Nozzles | 3,75 US gal/h 60°B | | 4,50 US gal/h 60°B | | 5,00 US gal/h 60°S / 3,5 US gal/h 60°S | |
| Control box / flame detection | TCH2... / QRB1 | | TCH2... / QRB1 | | TCH2... / MZ 770 S | |
| Fan motor | 230 V - 50 Hz - 250 W | | 230 V - 50 Hz - 300 W | | 230 V - 50 Hz - 750 W | |
| Electrical consumption | 445 W | | 540 W | | 27 + 785 W | |
| Flexible hoses | Rp 3/8" / DN6 x 1500 mm | | Rp 3/8" / DN6 x 1500 mm | | Rp 3/8" / DN6 x 1500 mm | |
| Acoustic level (LpA) | 67 dB(A) | | 69 dB(A) | | 70 dB(A) | |
| Head length | KN | KL | KN | KL | KN | KL |
| Complete burner code | 3833072 | 3833073 | 3833070 | 3833071 | 3836614 | 3836615 |

OTHER AVAILABLE VERSIONS

Versions for continuous ventilation and post-ventilation

SCOPE OF SUPPLY

The burner is delivered in its package complete with:

- 1 burner head with flange seal and securing screws
- 1 bag containing installation fittings
- 1 bag containing technical documentation (instruction manual, technical data, electrical diagram, exploded view and spare parts list)



DIMENSIONS (mm)

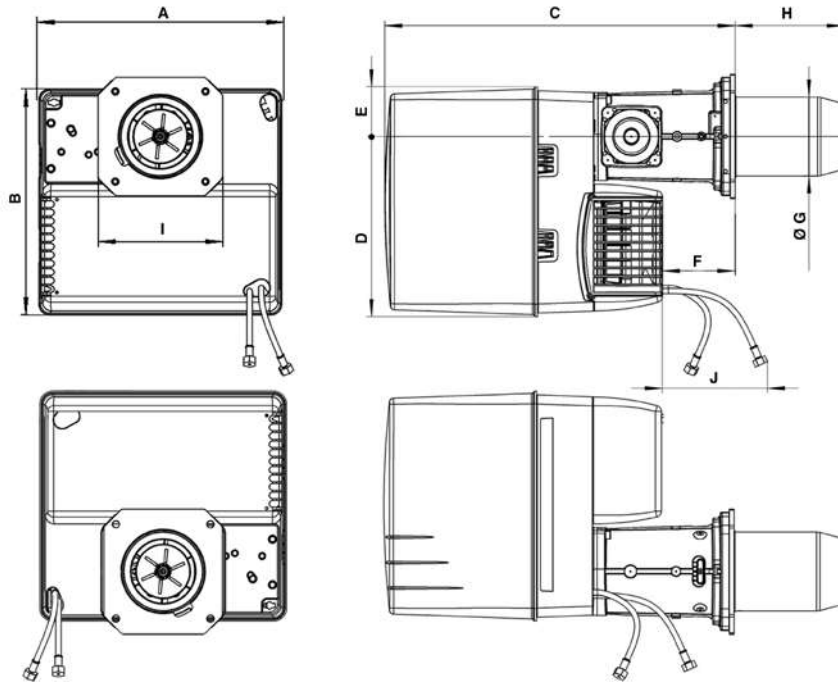

| Model | A | B | C | D | E | F | ØG | H | | I | J |
|-------|-----|-----|-----|-----|----|-----|-----|-----|-----|---------|------|
| | | | | | | | | KN | KL | | |
| VL3 | 406 | 379 | 576 | 297 | 82 | 120 | 130 | 180 | 320 | 195x205 | 1000 |
| VL4 | 465 | 475 | 640 | 377 | 97 | 149 | 150 | 220 | 360 | 245x245 | 1000 |

Connecting flange

| Model | Øa (mm) | b (mm) | c | d |
|-------|---------|---------|-----|-----|
| VL3 | 155-190 | 175-220 | M10 | 45° |
| VL4 | 190-240 | 200-270 | M10 | 45° |

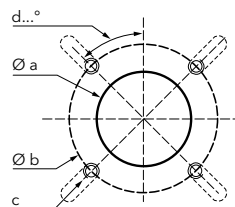

PACKAGING

The burner is delivered on a pallet in two packages containing:

- burner housing
- combustion head

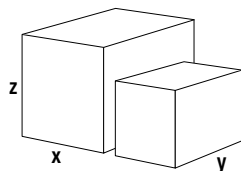

| Component | | Dimensions (mm) | | | Gross weight (kg) |
|-----------------|-----------|-----------------|-----|-----|-------------------|
| | | X | Y | Z | |
| Burner body | VL3.290 D | 440 | 400 | 520 | 22 |
| | VL3.360 D | 440 | 400 | 520 | 23 |
| | VL4.440 D | 490 | 490 | 590 | 30 |
| Combustion head | VL3 (KN) | 650 | 210 | 260 | 6 |
| | VL3 (KL) | 780 | 210 | 260 | 7 |
| | VL4 (KN) | 750 | 260 | 295 | 8,5 |
| | VL4 (KL) | 895 | 260 | 295 | 9,7 |

VL4.460 D / VL4.610 D

180 ... 610 kW
Two stages



- **Fuel:** light oil (viscosity 6 mm²/s at 20°C, H_v = 11,86 kWh/kg)
- **Emissions:** NO_x < 185 mg/kWh (NCV), Low NO_x class 2 burners according to EN267
- **Protection level:** IP 41

TECHNICAL DATA

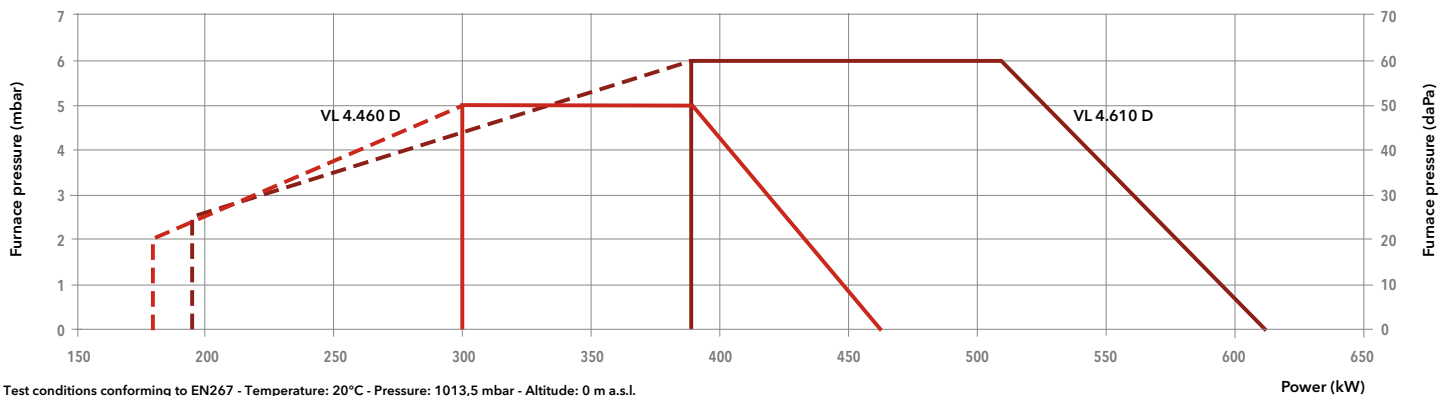

| Model | VL4.460 D | | VL4.610 D | |
|-------------------------------|--|---------|---|---------|
| Operation range | (180) 300 - 460 kW | | (195) 390 - 610 kW | |
| Fuel flow | (15,2) 25,3 - 38,8 kg/h | | (16,4) 32,9 - 51,4 kg/h | |
| Nozzles | 5,00 US gal/h 60°S / 3,5 US gal/h 60°S | | 6,50 US gal/h 60°S / 3,00 US gal/h 60°S | |
| Control box / flame detection | TCH2... / QRB1 | | TCH2... / QRB1 | |
| Fan motor | 230 V - 50 Hz - 420 W | | 230 V - 50 Hz - 750 W | |
| Electrical consumption | 545 W | | 830 W | |
| Flexible hoses | Rp 3/8" / DN6 x 1500 mm | | Rp 3/8" / DN6 x 1500 mm | |
| Acoustic level (LpA) | 70 dB(A) | | 71 dB(A) | |
| Head length | KN | KL | KN | KL |
| Complete burner code | 3833395 | 3833396 | 3833397 | 3833398 |

OTHER AVAILABLE VERSIONS

Versions for continuous ventilation and post-ventilation

SCOPE OF SUPPLY

The burner is delivered in its package complete with:

- 1 burner head with flange seal and securing screws
- 1 bag containing installation fittings
- 1 bag containing technical documentation (instruction manual, technical data, electrical diagram, exploded view and spare parts list)

DIMENSIONS (mm)

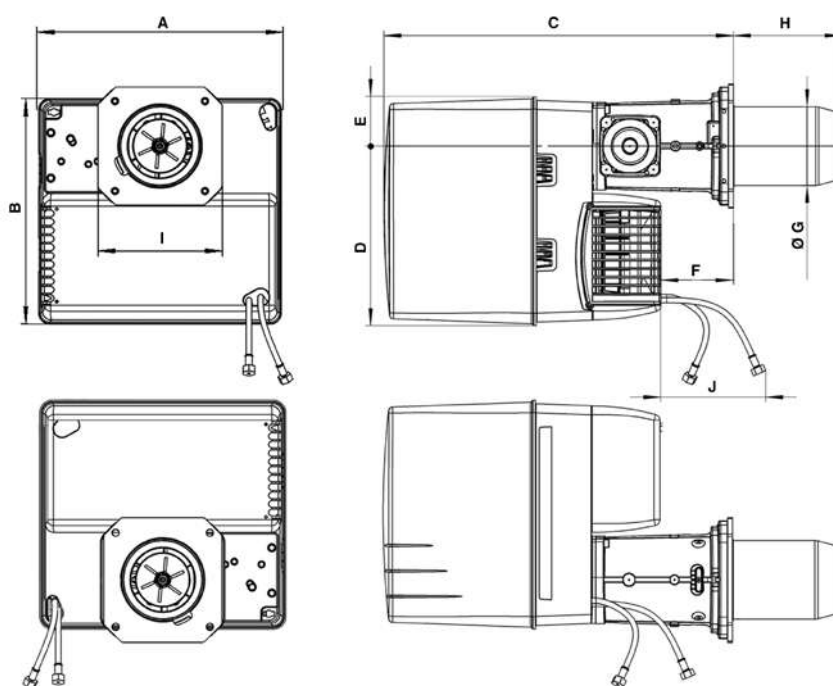

| A | B | C | D | E | F | ØG | H | | I | J |
|-----|-----|-----|-----|----|-----|-----|-----|-----|-----|------|
| | | | | | | | KN | KL | | |
| 465 | 475 | 640 | 377 | 97 | 149 | 150 | 220 | 360 | 245 | 1000 |

Connecting flange

| Øa (mm) | b (mm) | c | d |
|---------|---------|-----|-----|
| 190-240 | 200-270 | M10 | 45° |

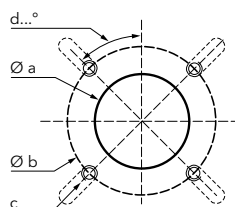

PACKAGING

The burner is delivered on a pallet in two packages containing:

- burner housing
- combustion head

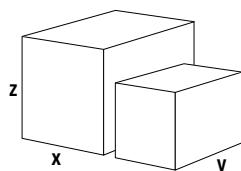

| Component | | Dimensions (mm) | | | Gross weight (kg) |
|-----------------|-----------|-----------------|-----|-----|-------------------|
| | | X | Y | Z | |
| Burner body | VL4.460 D | 490 | 490 | 590 | 30 |
| | VL4.610 D | 490 | 490 | 590 | 34,2 |
| Combustion head | KN | 750 | 260 | 295 | 8,5 |
| | KL | 895 | 260 | 295 | 9,7 |

VL5.950 D / VL5.1200 D

260 ... 1186 kW
Two stages



- **Fuel:** light oil (viscosity 6 mm²/s at 20°C, H_v = 11,86 kWh/kg)
- **Emissions:** NO_x < 185 mg/kWh (NCV), Low NO_x class 2 burners according to EN267
- **Protection level:** IP 21

TECHNICAL DATA

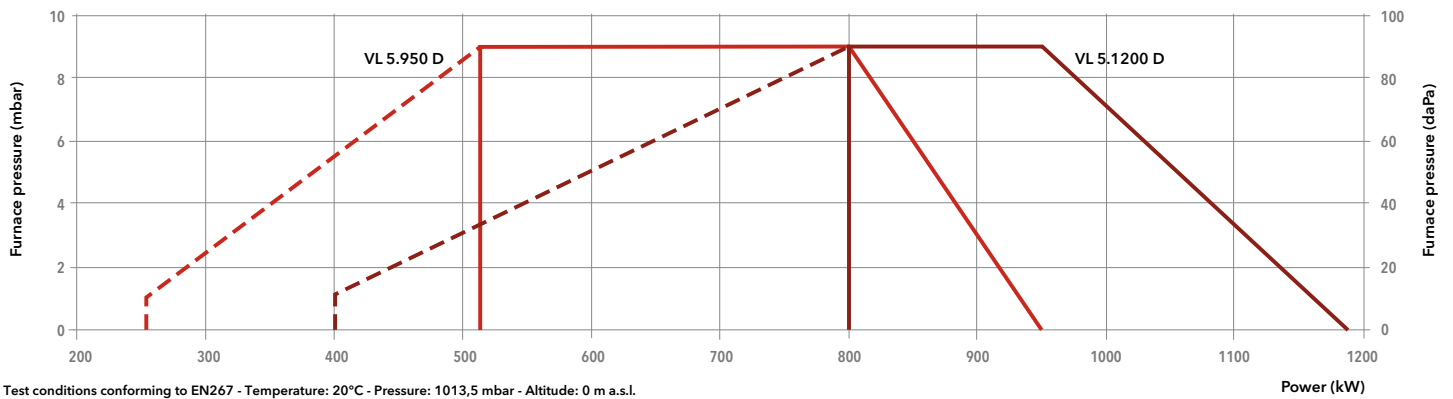

| Model | VL5.950 D | | | VL5.1200 D | | |
|-------------------------------|-------------------------------|---------|---------|-------------------------------|---------|---------|
| Operation range | (260) 510 - 950 kW | | | (400) 800 - 1186 kW | | |
| Fuel flow | (21,9) 43 - 80,1 kg/h | | | (33,7) 67,5 - 100 kg/h | | |
| Nozzles | 7,50 + 6,50 US gal/h | | | 8,50 + 7,50 US gal/h | | |
| Control box / flame detection | TCH2... / QRB1 | | | TCH2... / QRB1 | | |
| Fan motor | 230 V - 50 Hz - 1,5 kW | | | 230 V - 50 Hz - 1,5 kW | | |
| Electrical consumption | 160 + 1700 W | | | 155 + 1940 W | | |
| Flexible hoses | Rp 3/8" / M16 x 1,5 - 1500 mm | | | Rp 3/8" / M16 x 1,5 - 1500 mm | | |
| Acoustic level (LpA) | 70 dB(A) | | | 71 dB(A) | | |
| Head length | KN | KL | KM | KN | KL | KM |
| Complete burner code | 3833501 | 3833504 | 3833613 | 3833502 | 3833503 | 3833614 |

OTHER AVAILABLE VERSIONS

 Versions for continuous ventilation and post-ventilation

SCOPE OF SUPPLY

The burner is delivered in its package complete with:

- 1 burner head with flange seal and securing screws
- 1 bag containing installation fittings
- 1 bag containing technical documentation (instruction manual, technical data, electrical diagram, exploded view and spare parts list)



DIMENSIONS (mm)

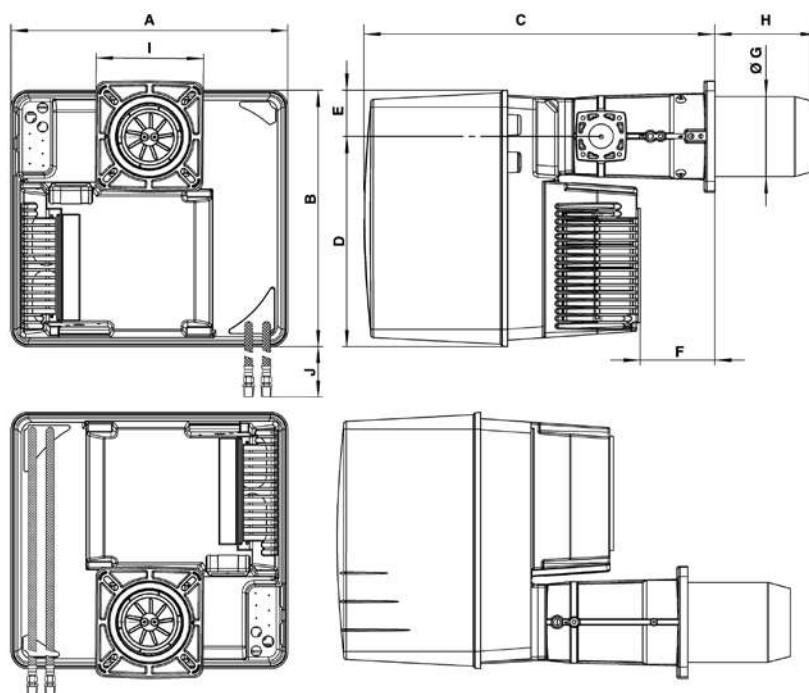

| A | B | C | D | E | F | ØG | H | | | I | J |
|-----|-----|-----|-----|----|-----|-----|-----|-----|-----|---------|-----|
| | | | | | | | KN | KM | KL | | |
| 581 | 549 | 752 | 450 | 99 | 164 | 170 | 215 | 325 | 435 | 230x238 | 950 |

Connecting flange

| Øa (mm) | b (mm) | c | d |
|---------|---------|-----|-----|
| 195 | 220-260 | M10 | 45° |

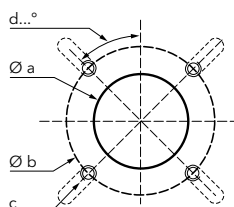

PACKAGING

The burner is delivered on a pallet in two packages containing:

- burner housing
- combustion head

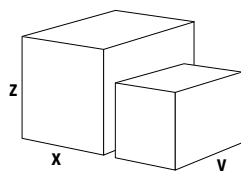

| Component | | Dimensions (mm) | | | Gross weight (kg) |
|-----------------|---------------|-----------------|-----|-----|-------------------|
| | | X | Y | Z | |
| Burner body | VL5.950 D | 800 | 600 | 850 | 58,8 |
| | VL5.1200 D | 800 | 600 | 850 | 58,6 |
| Combustion head | VL5.950 (KN) | 780 | 265 | 280 | 10 |
| | VL5.950 (KL) | 1010 | 265 | 280 | 13,5 |
| | VL5.950 (KM) | 1010 | 265 | 280 | 12,5 |
| | VL5.1200 (KN) | 780 | 265 | 280 | 10,1 |
| | VL5.1200 (KL) | 1010 | 265 | 280 | 13,5 |
| | VL5.1200 (KM) | 1010 | 265 | 280 | 12 |

VL4.460 DP / VL4.610 DP

180 ... 610 kW
Three stages



- **Fuel:** light oil (viscosity 6 mm²/s at 20°C, H_u = 11,86 kWh/kg)
- **Emissions:** NO_x < 185 mg/kWh (NCV), Low NO_x class 2 burners according to EN267
- **Protection level:** IP 41

TECHNICAL DATA

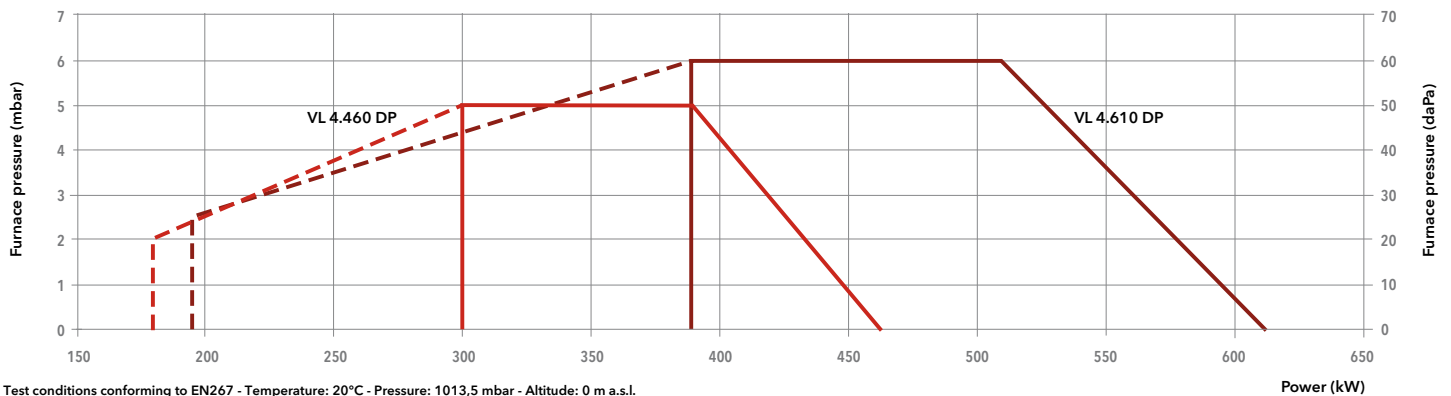

| Model | VL4.460 DP | | VL4.610 DP | |
|-------------------------------|-------------------------|---------|-------------------------|---------|
| Operation range | (180) 300 - 460 kW | | (195) 390 - 610 kW | |
| Fuel flow | (15,2) 25,3 - 38,8 kg/h | | (16,4) 32,9 - 51,4 kg/h | |
| Nozzles | 4,00 + 2,50 US gal/h | | 4,50 + 3,00 US gal/h | |
| Control box / flame detection | TCH2... / QRB1 | | TCH2... / QRB1 | |
| Fan motor | 230 V - 50 Hz - 420 W | | 230 V - 50 Hz - 750 W | |
| Electrical consumption | 545 W | | 830 W | |
| Flexible hoses | Rp 3/8" / DN6 x 1500 mm | | Rp 3/8" / DN6 x 1500 mm | |
| Acoustic level (LpA) | 70 dB(A) | | 71 dB(A) | |
| Head length | KN | KL | KN | KL |
| Complete burner code | 3833968 | 3833969 | 3833970 | 3833971 |

OTHER AVAILABLE VERSIONS

 Versions for continuous ventilation and post-ventilation

SCOPE OF SUPPLY

The burner is delivered in its package complete with:

- 1 burner head with flange seal and securing screws
- 1 bag containing installation fittings
- 1 bag containing technical documentation (instruction manual, technical data, electrical diagram, exploded view and spare parts list)

DIMENSIONS (mm)

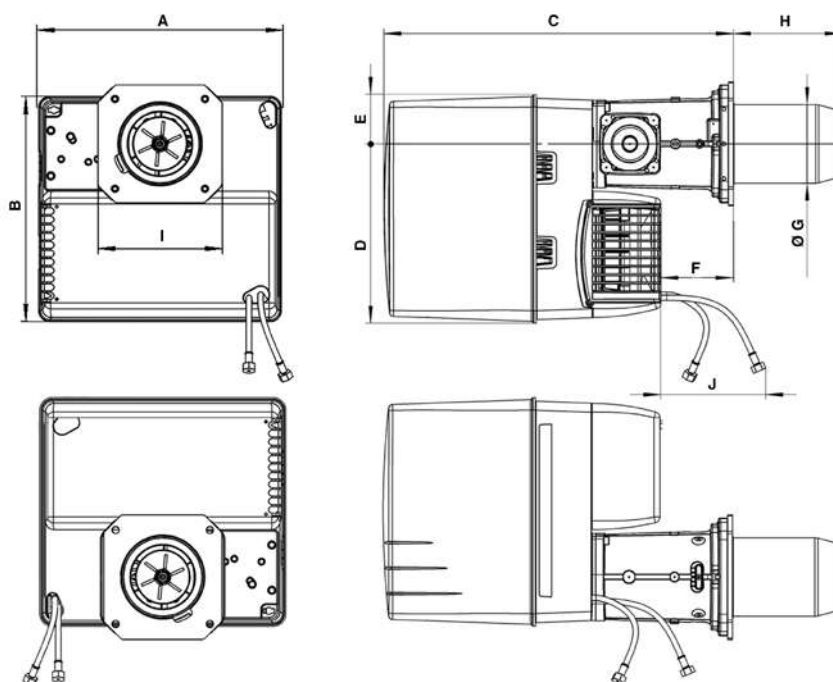

| A | B | C | D | E | F | ØG | H | | I | J |
|-----|-----|-----|-----|----|-----|-----|-----|-----|-----|------|
| | | | | | | | KN | KL | | |
| 465 | 475 | 640 | 377 | 97 | 149 | 150 | 220 | 360 | 245 | 1000 |

Connecting flange

| Øa (mm) | b (mm) | c | d |
|---------|---------|-----|-----|
| 190-240 | 200-270 | M10 | 45° |

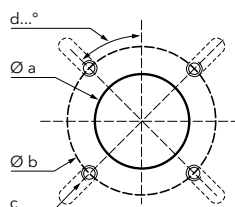

PACKAGING

The burner is delivered on a pallet in two packages containing:

- burner housing
- combustion head

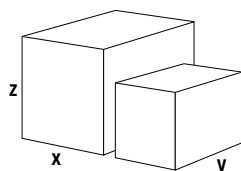

| Component | | Dimensions (mm) | | | Gross weight (kg) |
|-----------------|------------|-----------------|-----|-----|-------------------|
| | | X | Y | Z | |
| Burner body | VL4.460 DP | 490 | 490 | 590 | 30 |
| | VL4.610 DP | 490 | 490 | 590 | 34,2 |
| Combustion head | KN | 750 | 260 | 295 | 8,5 |
| | KL | 895 | 260 | 295 | 9,7 |

VL5.950 DP / VL5.1200 DP

260 ... 1186 kW
Three stages



- **Fuel:** light oil (viscosity 6 mm²/s at 20°C, H_v = 11,86 kWh/kg)
- **Emissions:** NO_x < 185 mg/kWh (NCV), Low NO_x class 2 burners according to EN267
- **Protection level:** IP 21

TECHNICAL DATA

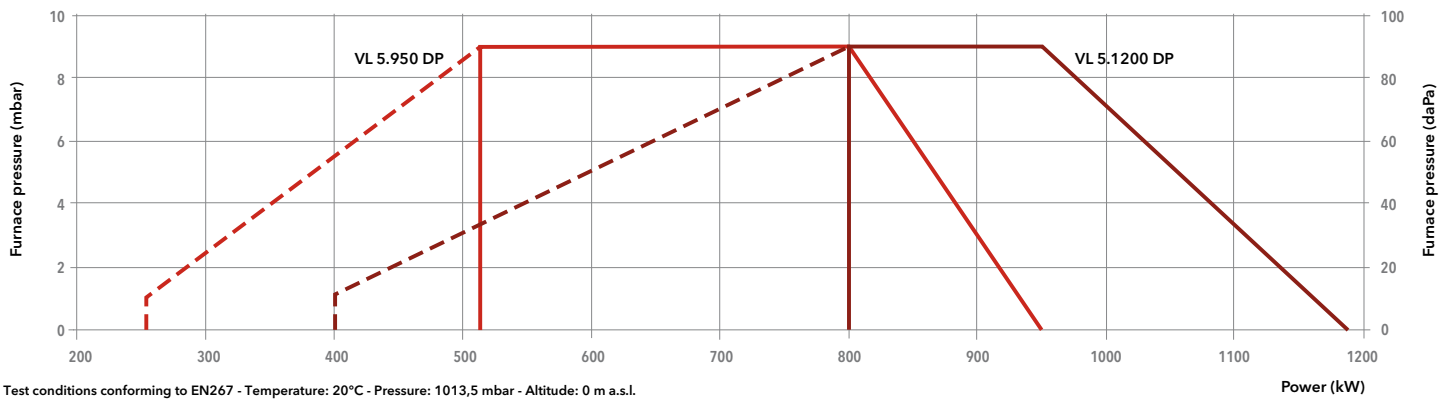

| Model | VL5.950 DP | | | VL5.1200 DP | | |
|-------------------------------|-------------------------------|---------|---------|-------------------------------|---------|---------|
| Operation range | (260) 510 - 950 kW | | | (400) 800 - 1186 kW | | |
| Fuel flow | (21,9) 43 - 80,1 kg/h | | | (33,7) 67,5 - 100 kg/h | | |
| Nozzles | 7,50 + 6,50 US gal/h | | | 8,50 + 7,50 US gal/h | | |
| Control box / flame detection | TCH2... / QRB1 | | | TCH2... / QRB1 | | |
| Fan motor | 230/400 V - 50 Hz - 1,5 kW | | | 230/400 V - 50 Hz - 1,5 kW | | |
| Electrical consumption | 160 + 1700 W | | | 155 + 1940 W | | |
| Flexible hoses | Rp 3/8" / M16 x 1,5 - 1500 mm | | | Rp 3/8" / M16 x 1,5 - 1500 mm | | |
| Acoustic level (LpA) | 70 dB(A) | | | 71 dB(A) | | |
| Head length | KN | KL | KM | KN | KL | KM |
| Complete burner code | 3833956 | 3833957 | 3833958 | 3833959 | 3833960 | 3833961 |

OTHER AVAILABLE VERSIONS

 Versions for continuous ventilation and post-ventilation

SCOPE OF SUPPLY

The burner is delivered in its package complete with:

- 1 burner head with flange seal and securing screws
- 1 bag containing installation fittings
- 1 bag containing technical documentation (instruction manual, technical data, electrical diagram, exploded view and spare parts list)

DIMENSIONS (mm)

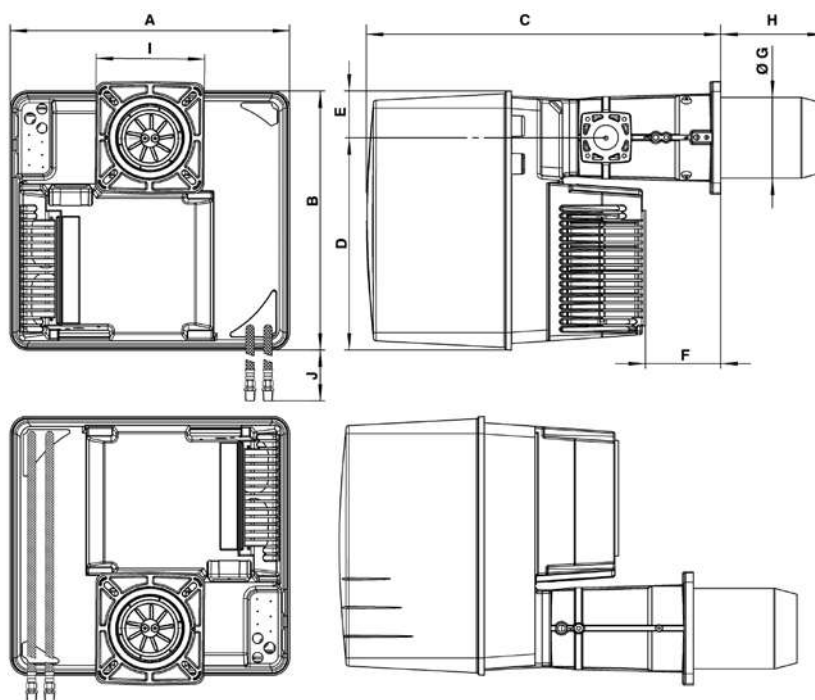

| A | B | C | D | E | F | ØG | H | | | I | J |
|-----|-----|-----|-----|----|-----|-----|-----|-----|-----|-----------|-----|
| | | | | | | | KN | KM | KL | | |
| 581 | 549 | 752 | 450 | 99 | 164 | 170 | 215 | 325 | 435 | 230 x 238 | 950 |

Connecting flange

| Øa (mm) | b (mm) | c | d |
|---------|---------|-----|-----|
| 195 | 220-260 | M10 | 45° |

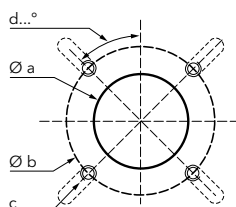

PACKAGING

The burner is delivered on a pallet in two packages containing:

- burner housing
- combustion head

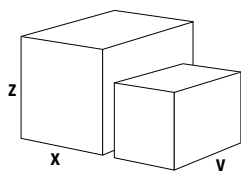

| Component | | Dimensions (mm) | | | Gross weight (kg) |
|-----------------|---------------|-----------------|-----|-----|-------------------|
| | | X | Y | Z | |
| Burner body | VL5.950 DP | 800 | 600 | 850 | 58,8 |
| | VL5.1200 DP | 800 | 600 | 850 | 58,6 |
| Combustion head | VL5.950 (KN) | 780 | 265 | 280 | 10 |
| | VL5.950 (KL) | 1010 | 265 | 280 | 13,5 |
| | VL5.950 (KM) | 1010 | 265 | 280 | 12,5 |
| | VL5.1200 (KN) | 780 | 265 | 280 | 10,1 |
| | VL5.1200 (KL) | 1010 | 265 | 280 | 13,5 |
| | VL5.1200 (KM) | 1010 | 265 | 280 | 12 |

VL6.1600 DP / VL6.2100 DP

320 ... 2080 kW
Three stages



- **Fuel:** light oil (viscosity 6 mm²/s at 20°C, H_v = 11,86 kWh/kg)
- **Emissions:** NO_x < 185 mg/kWh (NCV), Low NO_x class 2 burners according to EN267
- **Protection level:** IP 21

TECHNICAL DATA

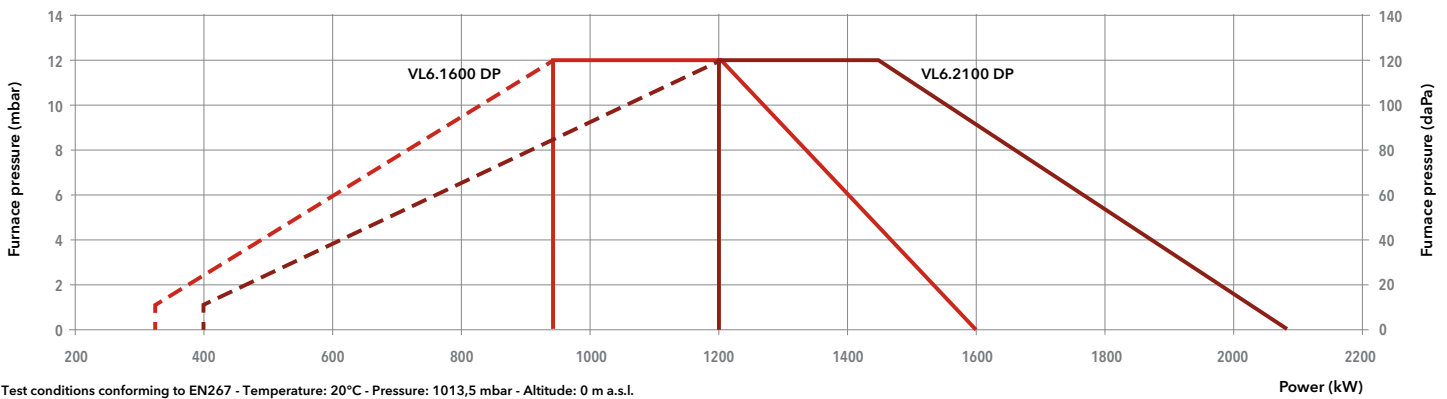

| Model | VL6.1600 DP | | | VL6.2100 DP | | |
|-------------------------------|-------------------------------|---------|---------|-------------------------------|---------|---------|
| Operation range | (320) 950 - 1600 kW | | | (400) 1200 - 2080 kW | | |
| Fuel flow | (27) 80,1 - 124,9 kg/h | | | (33,7) 101,2 - 177 kg/h | | |
| Nozzles | 3 x 6,50 US gal/h | | | 3 x 8,50 US gal/h | | |
| Control box / flame detection | TCH3... / QRB1 | | | TCH3... / QRB1 | | |
| Fan motor | 230/400 V - 50 Hz - 2,2 kW | | | 230/400 V - 50 Hz - 2,5 kW | | |
| Electrical consumption | 352 + 2240 W | | | 380 + 2840 W | | |
| Flexible hoses | Rp 1/2" / M16 x 1,5 - 1500 mm | | | Rp 1/2" / M16 x 1,5 - 1500 mm | | |
| Acoustic level (LpA) | 78,1 dB(A) | | | 79,3 dB(A) | | |
| Head length | KN | KL | KM | KN | KL | KM |
| Complete burner code | 3833694 | 3833695 | 3833696 | 3833697 | 3833698 | 3833699 |

OTHER AVAILABLE VERSIONS

 Versions for continuous ventilation and post-ventilation

SCOPE OF SUPPLY

The burner is delivered in its package complete with:

- 1 burner head with flange seal and securing screws
- 1 bag containing installation fittings
- 1 bag containing technical documentation (instruction manual, technical data, electrical diagram, exploded view and spare parts list)

DIMENSIONS (mm)

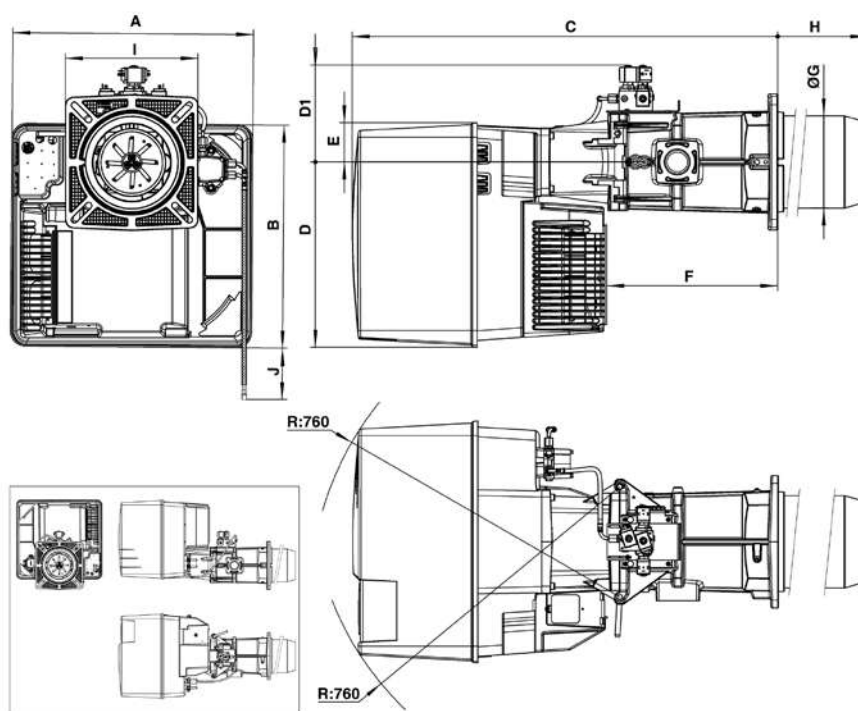

| A | B | C | D | D1 | E | F | ØG | H | | | I | J |
|-----|-----|------|-----|-----|----|-----|-----|-----|-----|-----|---------|-----|
| | | | | | | | | KN | KM | KL | | |
| 592 | 553 | 1050 | 456 | 239 | 97 | 421 | 227 | 270 | 370 | 470 | 326x335 | 950 |

Connecting flange

| Øa (mm) | b (mm) | c | d |
|---------|---------|-----|-----|
| 250 | 300-400 | M12 | 45° |

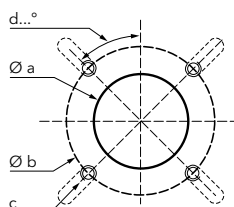

PACKAGING

The burner is delivered on a pallet in two packages containing:

- burner housing
- combustion head

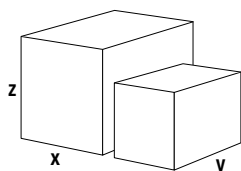

| Component | | Dimensions (mm) | | | Gross weight (kg) |
|-----------------|---------------|-----------------|-----|-----|-------------------|
| | | X | Y | Z | |
| Burner body | VL6.1600 DP | 800 | 600 | 850 | 79,4 |
| | VL6.2100 DP | 800 | 600 | 850 | 79,6 |
| Combustion head | VL6.1600 (KN) | 800 | 380 | 420 | 42 |
| | VL6.1600 (KL) | 1000 | 420 | 380 | 29,8 |
| | VL6.1600 (KM) | 1000 | 420 | 380 | 28,3 |
| | VL6.2100 (KN) | 800 | 380 | 420 | 24 |
| | VL6.2100 (KL) | 1000 | 380 | 420 | 42 |
| | VL6.2100 (KM) | 1000 | 380 | 420 | 42 |

A modulating burner allows to adapt the power delivered according to the boiler/system requirements.

To obtain the modulating operation it is necessary to install a power regulator and the relative temperature or pressure probes, chosen in accordance with the specific requirements of the installation.

To simplify the selection of regulator and probes ELCO offers specific kits mounted in factory on the burner:

Kit RWF 50 with sensor

RWF 50 is a basic controller with analog output or 3-position output

| Description | Burners | Code |
|--------------------------------------|-----------|------------|
| Kit GEP130 (water - immersion probe) | V2 | 3834039 |
| Kit GEA130 (water - strap-on probe) | V2 | 3834040 |
| Kit IEP130 (water - immersion probe) | V3 | 3834043 |
| Kit IEA130 (water - strap-on probe) | V3 | 3834044 |
| Kit LEP130 (water - immersion probe) | V4 | 3834047 |
| Kit LEA130 (water - strap-on probe) | V4 | 3834048 |
| Kit MEP130 (water - immersion probe) | V5 and V6 | 3834049 |
| Kit MEA130 (water - strap-on probe) | V5 and V6 | 3834050 |
| MIF001R (kit mounted in factory) | V2 to V6 | on request |



Example:

Kit with immersion probe with working field limitation up to 130°C for water tube boiler, mounted in factory on a VG2.210 D E

Kit GEP130
(water - immersion probe)
3834039

+

MIF001R
(kit mounted
in factory)

Kit RWF 55 with sensor

RWF 55 offers some more functions, such us:

- Modbus slave RS485 interface as standard
- 3 analog inputs
- Accepts thermocouples J, K, N, T, etc. as input
- Analog output DC 0(4)...20mA or 0...10V

| Description | Burners | Code |
|---|-----------|------------|
| Kit LEP 130 (water - immersion sensor) | V5 and V6 | 3834602 |
| Kit LEA 130 (water - strap-on probe) | V5 and V6 | 3834603 |
| Kit LVA 16 (steam - pressure probe) | V5 and V6 | 3834604 |
| Acc AQE21.02 (kit for using Kit LEP 130 on hot air generator) | V5 and V6 | 3834307 |
| MIF001R (kit mounted in factory) | V5 and V6 | on request |



Example:

Kit with pressure probe for steam boiler, mounted in factory on a VG5.950 DP

Kit LVA 16
(steam - pressure probe)
3834604

+

MIF001R
(kit mounted
in factory)

RWF 50 stand-alone and wiring kit

| Description | Burners | Code |
|--------------------------|-----------|---------|
| Load controller RWF50 SA | V2 to V6 | 3833498 |
| Wiring kit RWF50 EW03 | V2 | 3834056 |
| Wiring kit RWF50 EW04 | V3 | 3834057 |
| Wiring kit RWF50 EW05 | V4 | 3834058 |
| Wiring kit RWF50 W06-07 | V5 and V6 | 3834032 |



Example:
Power regulator RWF50 for VG3.290 DP E and wiring kit

Load controller
RWF50 SA
3833498

+

Wiring kit
RWF50 EW04
3834057

RWF 55 stand-alone and wiring kit

| Description | Burners | Code |
|--------------------------|----------------|---------|
| Load controller RWF55 SA | V5 and V6* | 3834298 |
| Wiring kit RWF55 W06-07 | V5 and V6* | 3834299 |
| Load controller RWF55.5 | EK EVO 4 and 5 | 3147730 |



*: for VGL5 and VGL6 the RWF55 can be ordered but it must be installed in our factory

Example:
Power regulator RWF55 for VG5.1200 DP and wiring kit

Load controller
RWF55 SA
3834298

+

Wiring kit
RWF55 W06-07
3834299

Example:
Power regulator RWF55 for EK EVO 4.1000 L-EOT

Load controller
RWF55.5
3147730

Separated sensors

| Description | Burners | Code |
|--|----------|----------|
| Acc TIP 130 (Immersion probe, water 130°C) | V2 to V6 | 3833163 |
| Acc TSP 130 (Strap-on probe, water 130°C) | V2 to V6 | 3833165 |
| Acc TIP 400 (Hot water/air probe Pt100 / 400°C - L = 160 mm) | V2 to V6 | 65300274 |
| Acc QBE2002-P1 (0 ... 1 bar) | V2 to V6 | 3834310 |
| Acc QBE2002-P2 (0 ... 2 bar) | V2 to V6 | 3834311 |
| Acc QBE2002-P4 (0 ... 4 bar) | V2 to V6 | 3834312 |
| Acc QBE2002-P10 (0 ... 10 bar) | V2 to V6 | 3834313 |
| Acc QBE2002-P16 (0 ... 16 bar) | V2 to V6 | 3834305 |
| Acc QBE2002-P25 (0 ... 25 bar) | V2 to V6 | 3834314 |
| Acc AQB2.1 (QBE sensor support) | V2 to V6 | 3834309 |
| Acc AQB2001 (1 meter connection pipe) | V2 to V6 | 3834308 |
| Acc QAC22 (external probe) | V2 to V6 | 13018513 |



O₂ TRIM for BT3xx

This kit is used to optimize the combustion in order to keep the air excess as much stable as possible irrespective of the changes that can occur during operations, for instance slight calorific value variations, combustion air temperature and pressure. This improves the seasonal efficiency and therefore reduces the fuel consumption. The kit includes the following components:

- Lambda transmitter LT3
- Lambda probe LS2
- Probe installation fitting (PIF)
- Gas extraction device (GED)

The control unit has to be installed close to the probe (max 25 m of cable).

The probe needs a calibration but no reference gas is necessary.

The display shows the O₂ content.

Maximum distance between the LT3 and the burner control panel is 500 m.

| Description | Additional LSB modules installed at LT3 | GED length | Code |
|--|--|------------|----------------|
| Kit for O₂ trim (LT3 + LS2) Flue temp max 300 °C - Display for O₂ visualization (Note: for models equipped with BT3xx this kit needs a LCM module installed in the burner control panel) | none | 150 mm | 3759296 |
| | | 300 mm | 3759297 |
| | | 450 mm | 3759298 |
| | 4x 0/4-20 mA output | 150 mm | 3759299 |
| | | 300 mm | 3759300 |
| | | 450 mm | 3759301 |
| | 4x 0/4-20 mA output + 4x digital output | 150 mm | 3759302 |
| | | 300 mm | 3759303 |
| | | 450 mm | 3759304 |

The lambda probe LS2 is equipped with a 2 m long connection cable to connect the probe to the transmitter (LT3). This connection cable can be extended by a maximum of 23 m (total of 25 m). For longer distances the admission does expire. Therefore, there are ready-made cables as well as the probes connection box (PCB).

The PCB is a small terminal box that is connected to the 2 m cable already existing on the probe. The wiring between the PCB and the transmitter must be carried out on the construction site with suitable cables and trained personnel.

| Description | Code |
|-------------------------|----------------|
| Extension LS2 cable 5m | 3759314 |
| Extension LS2 cable 10m | 3759315 |
| Extension LS2 cable 20m | 3759316 |
| Extension LS2 PCB | 3759317 |

O₂ TRIM with CO measure for BT3xx

This kit is used for optimizing the combustion in order to keep the air excess as low as possible in order to maximize the seasonal efficiency and therefore minimize the fuel consumption. In addition to the features of the O₂ trim only, this kit reduces the air excess to its minimum because this system continuously measures the content of unburned fuel (CO_e) in the flue: should the air excess be reduced too much, the CO_e raises and the system reacts by increasing the air excess in order to keep firing in safe conditions. The kit includes the following components:

- Lambda transmitter LT3-F
- Lambda probe KS1D
- Probe installation fitting (PIF)
- Gas extraction device (GED)

The control unit has to be installed close to the probe (max 10 m of cable).

The probe needs a calibration but no reference gas is necessary.

The display shows the O₂ and CO_e content.

Maximum distance between the LT3-F and the burner control panel is 500 m.

| Description | Additional LSB modules installed at LT3-F | GED length | Code |
|--|--|------------|----------------|
| Kit for O₂ trim and CO control (LT3-F + KS1D) Flue temp max 300 °C (Note: for models equipped with BT3xx this kit needs a LCM module installed in the burner control panel) | none | 150 mm | 3759305 |
| | | 300 mm | 3759306 |
| | | 450 mm | 3759307 |
| | 4x 0/4-20 mA output | 150 mm | 3759308 |
| | | 300 mm | 3759309 |
| | | 450 mm | 3759310 |
| | 4x 0/4-20 mA output + 4x digital output | 150 mm | 3759311 |
| | | 300 mm | 3759312 |
| | | 450 mm | 3759313 |

The lambda probe KS1D is equipped with a 2 m long connection cable to connect the probe to the transmitter (LT3-F). This connection cable can be extended by a maximum of 8 m (total of 10 m). For longer distances the admission does expire. Therefore, there is a ready-made cable as well as the probes connection box (PCB).

The PCB is a small terminal box that is connected to the 2 m cable already existing on the probe. The wiring between the PCB and the transmitter must be carried out on the construction site with suitable cables and trained personnel.

| Description | Code |
|-------------------------|----------------|
| Extension KS1D cable 5m | 3759318 |
| Extension KS1D PCB | 3759319 |

Kit LCM for BT3xx

| Description | Burners | Code |
|---|--------------|---------|
| Analog input and output (chosen among 0-10 V and 4-20 mA) | V2 M to V6 M | 3836239 |
| | EK EVO 4/5 | 3147726 |

Communication modules

| Description | Burners | Code |
|---|-----------------------------|---------|
| ModBus/BT3 (EBM100) mounted on the burner | EK EVO 4/5 | 3147727 |
| ProfiBus/BT3 (PBM100) mounted on the burner | EK EVO 4/5 | 3147728 |
| ModBus/BT3 (EBM100) for external installation | V2 M to V6 M and EK EVO 4/5 | 3754456 |
| ProfiBus/BT3 (PBM100) for external installation | V2 M to V6 M and EK EVO 4/5 | 3752986 |

Display

| Description | Burners | Code |
|---|------------|---------|
| Lamtec UI300 display (to be mounted on the control box instead of the native display) | EK EVO 4/5 | 3147729 |

Remote software

| Description | Burners | Code |
|---|--------------|---------|
| Kit to connect a PC laptop to BT3xx for its parametrization (LSA100 + USB/CAN + cd-rom) | V2 M to V6 M | 3751130 |

MDE2 System

| Description | Burners | Code |
|---|-----------|---------|
| PC interface tool to connect the control box to a personal computer allowing transmission of burner operation data, fault signals and service information | V1 and V2 | 3833018 |

Cable for 0-10V load input ⁽¹⁾ (applicable to Ariston TCG2/TCH2 or higher)

| Description | Burners | Code |
|-----------------|----------|---------|
| Kit 0-10V BCU/0 | V2 to V6 | 3834253 |

⁽¹⁾: the 0-10 V must be exchanged with a device with the electric feeding shared with the burner. Alternatively a galvanic separator (code 3144698) must be fitted

Cable for 0-10V load input ⁽¹⁾ + potentiometer for actuator position feedback (applicable to Ariston TCG2/TCH2 or higher)

| Description | Burners | Code |
|-----------------|------------|---------|
| Kit 0-10V BCU/1 | V2, V3, V4 | 3834170 |
| Kit 0-10V BCU/2 | V5, V6 | 3834171 |

⁽¹⁾: the 0-10 V must be exchanged with a device with the electric feeding shared with the burner. Alternatively a galvanic separator (code 3144698) must be fitted

Analog signal converter and galvanic separator ⁽²⁾ (applicable to Ariston TCG2/TCH2 or higher)

| Description | Burners | Code |
|---|----------|---------|
| Conversion among 0-10 V, 4-20 mA, 0-20 mA signals | V2 to V6 | 3144698 |

⁽²⁾: all the items provided with code 3834253 are already included in this kit

Front boiler flange

| Description | Burners | Code |
|-------------|-----------|----------|
| CP1 | V1 | 13018495 |
| CP2 | V2 | 13018496 |
| CP3.1 | V3 | 3833151 |
| CP4 | V4 and V5 | 13018499 |
| CP5.1 | V6 | 13008019 |

Sound proofing box - noise reduction 15...20 dB(A)

| Description | Burners | Code |
|-------------|---------|------------|
| CI20 | V2 | on request |
| CI21 | V3 | on request |
| CI22 | V4 | on request |
| CI23 | V5 | on request |
| CI24 | V6 | on request |

Sound proofing box - noise reduction 20...30 dB(A)

| Description | Burners | Code |
|-------------|---------|------------|
| CI31 | V3 | on request |
| CI32 | V4 | on request |
| CI33 | V5 | on request |
| CI34 | V6 | on request |

External air intake connection kit

| Description | Burners | Code |
|------------------------------|------------------|----------|
| Kit RG4 (Ø 50mm, directable) | VB1.20 to V1.55 | 13004320 |
| Kit RG9 (Ø 50) | VB1.20 to VB1.95 | 13011996 |
| Kit RG10 (Ø 100) | V2 | 13018822 |
| Kit RG11 (Ø 160) | V3 | 3833152 |
| Kit RG12 (Ø 200) | V4 | 3833429 |
| Kit RG3 (Ø 250) | V5 and V6 | 13014375 |

External valve connection kit

| Description | Burners | Code |
|-------------------------------------|----------|----------|
| Connector for safety solenoid valve | V1 to V4 | 13010959 |

Maximum gas pressure switch

| Description | Burners | Code |
|--|--------------------|---------|
| Kit for burners fitted with Artison BCU TCxx | V1 to V6 | 3833903 |
| Kit for burners fitted with BT3xx | V2 M... to V6 M... | 3836857 |

Gas and air manometer with push button

| Description | Code |
|---------------|----------|
| AGM 0-60mbar | 13002181 |
| AGM 0-100mbar | 13018509 |
| AGM 0-400mbar | 13018510 |

Gas filter

| Description | Code |
|---------------|---------|
| RP 15 - 1/2" | 3141957 |
| RP 20 - 3/4" | 3142045 |
| RP 25 - 1" | 3142046 |
| RP 40 - 1"1/2 | 3141954 |
| RP 50 - 2" | 3121384 |
| DN 65 - 2"1/2 | 3124111 |
| DN 80 - 3" | 3142088 |
| DN 100 - 4" | 3142205 |
| DN 125 - 5" | 3142206 |

Antivibration coupling - Compensator

| Description | Code |
|------------------------------|----------|
| RP 1/2" threaded connection | 3122321 |
| RP 3/4" threaded connection | 3122322 |
| Rp 1" threaded connection | 3122323 |
| RP 1"1/4 threaded connection | 3122324 |
| Rp 1"1/2 threaded connection | 3122325 |
| Rp 2" threaded connection | 3122326 |
| DN50 flanged connection | 12001014 |
| DN65 flanged connection | 3142060 |
| DN80 flanged connection | 3122328 |
| DN100 flanged connection | 3122329 |
| DN125 flanged connection | 3142061 |

Ball valve

| Description | Code |
|------------------------------|---------|
| Rp 1/2" threaded connection | 3142000 |
| Rp 3/4" threaded connection | 3142254 |
| Rp 1" threaded connection | 3121430 |
| Rp 1"1/4 threaded connection | 3142253 |
| Rp 1"1/2 threaded connection | 3142101 |
| Rp 2" threaded connection | 3142102 |
| DN65 flanged connection | 3142062 |
| DN80 flanged connection | 3143730 |
| DN100 flanged connection | 3141997 |
| DN125 flanged connection | 3141998 |

Kit Variatron

| Description | Burners | Code |
|----------------------|-----------------|---------|
| Kit Variatron 1,5 KW | VG5.950/1200 DP | 3836887 |
| Kit Variatron 2,2 KW | VG6.1600 DP | 3836888 |
| Kit Variatron 3 KW | VG6.2100 DP | 3836889 |

Kit remote reset

| Description | Burners | Code |
|--|--------------------|----------|
| Kit for burners fitted with Artison BCU TCxx | V1 to V6 | 13011486 |
| Kit for burners fitted with BT3xx | V2 M... to V6 M... | 3144622 |

Kit additional oil safety valve

| Description | Burners | Code |
|------------------|-----------|---------|
| Kit OSV 01/02/03 | V1 and V2 | 3832706 |
| Kit OSV 06 | V5 | 3834195 |

"Flame on" digital output (BT300)

| Description | Burners | Code |
|-------------|--------------|---------|
| Kit ROS BT3 | V2 M to V6 M | 3144260 |

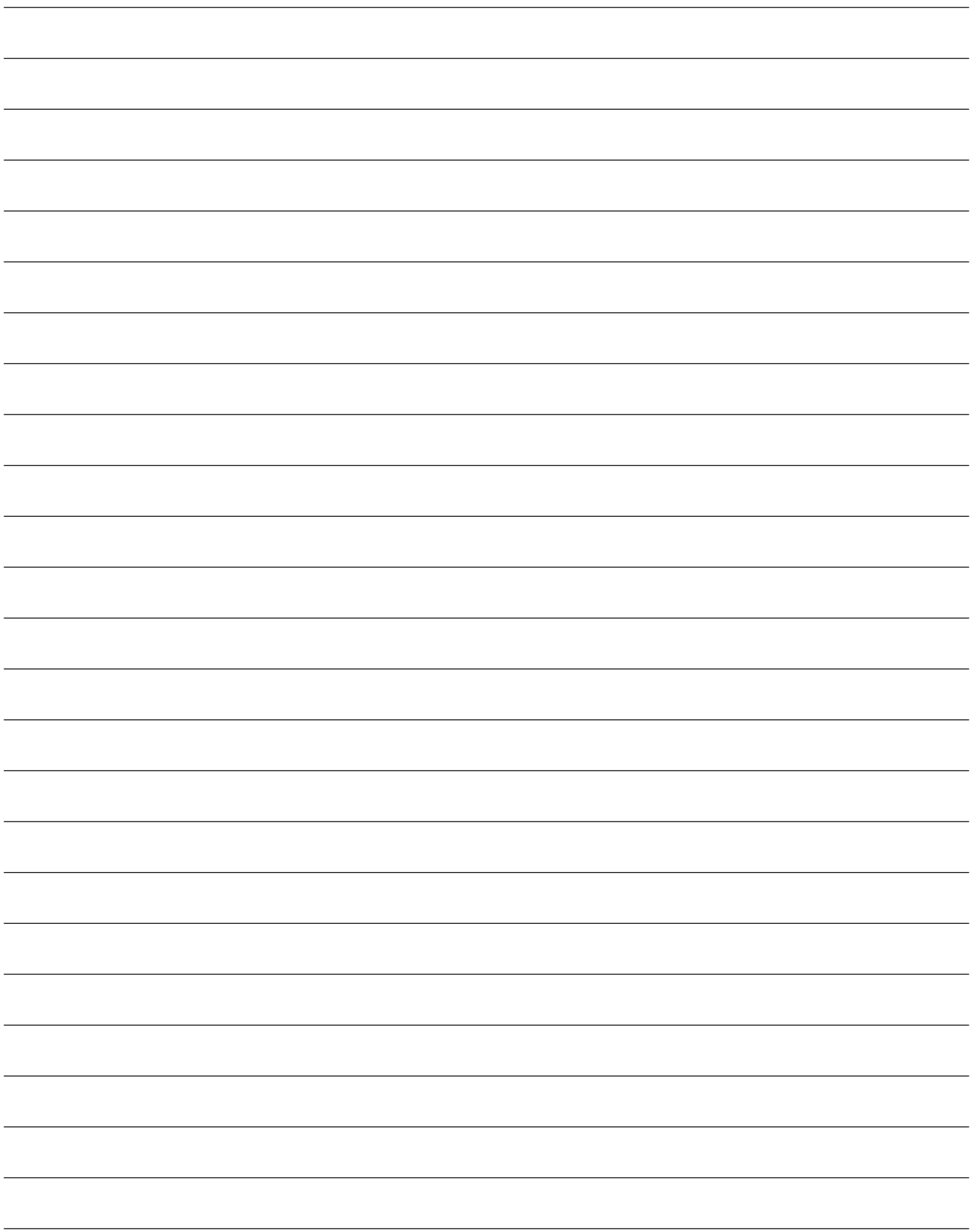

Subsidiaries ELCO

GERMANY

ELCO GmbH
Dreieichstraße 10
Mörfelden-Walldorf
Tel. +49 (0)6105 287-287
Fax +49 (0)6105 287-199

NETHERLANDS

Elco Burners B.V.
Meerpaalweg, 1
1332 BB Almere
P.O. box 30048
1303 AA Almere
Tel. +31 088 69 573 11
Fax +31 088 69 573 90

FRANCE

14, rue du Saule Trapu
Parc d'activité du Moulin
91882 Massy
Tel. +33 01 60 13 64 64
Fax +33 01 60 13 64 65

SWITZERLAND

Elcotherm AG
Sarganserstrasse 100
7324 Vilters
Tel. +41 (0)81 725 25 25
Fax +41 (0)81 723 13 59

AUSTRIA

ELCO Austria GmbH
Aredstraße 16 - 18
2544 Leobersdorf
Tel. +43 (0)2256 639 99 32
Fax +43 (0)2256 644 11

ITALY

Via Roma, 64
31023 Resana (TV)
Tel. +39 0423 719 500
Fax +39 0423 719 580

UK & IRELAND

Ariston Thermo UK Ltd
Suite 3, The Crown House
Blackpole East, Blackpole Road,
Worcester WR3 8SG
Tel. +44 01905 788010
Fax +44 01905 788011

RUSSIA

Ariston Thermo RUS
Eniseyskaya str. 1, bld 1,
Office Center "LIRA" #438
129344 Moscow
Tel. +7 495 213 0300 #5700
Fax +7 495 213 0302

CHINA

Ariston Thermo (China) Co., Ltd.
F/15, V-Capital Bldg
No. 333 Xian Xia Road
200336 Shanghai
Tel. +86 21 6039 8691
Fax +86 21 6039 8620

Contact us to know more
about our products and solutions

www.elco-burners.com
contact@elco-burners.com

Version 2.0 | 09/12/2021

All rights reserved | ELCO declines all responsibility for any printing mistakes or any content transcription in the present document and reserves the right to modify, without prior notice, any product datas or characteristics